

MIL-DTL-83513 Micro-D Plastic Connectors

R04 Series Microminiature Rectangular Connector

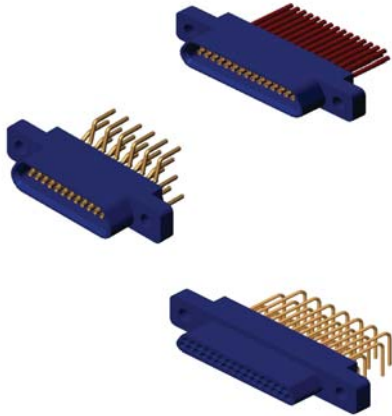

Introduction

- Micro-D connectors
- Twist pin contact, high density interconnection
- Plastic connectors, raw material: PPS or PBT
PPS-15% Glass filled polyphenylene sulfide
PBT-20% Glass filled polybutylene terephthalate
- Contacts:BeCu,gold over nickel plating
- Gold thickness:1.27micron minimum)
- Termination style:
Crimp,solder cup,straight to PCB,riht angle to PCB
- The sectional area of cable:0.1mm²~0.15mm²,0.07mm²
- Meet MIL-DTL-83513

Specification

- Environment temperature: -55°C~125°C
- Vibration: 10Hz~2000Hz, 196m/s²
- Random vibration: Power spectrum density 0.4G²/Hz
root mean square value of total acceleration 23.1G
- Shock: 735m/s² 11ms
- Rated current: 3A
- Contact resistance: ≤10mΩ
- Insulation resistance: ≥5000 MΩ
- Dielectric strength: 800V
- Durability: 500 times

Contact arrangements

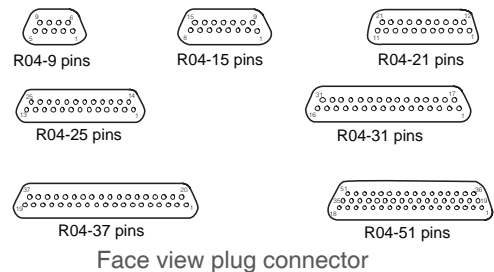

How To Order

Sample part number **R04 -25 PI S K03**

Series:

R04—Series of Sunkye,plastic shell

Contact number:

9, 15, 21, 25, 31, 37, 51ins

Contact type :

PI—pin in plug RH—socket in receptacle













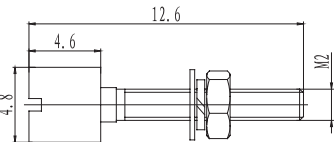

Termination style:

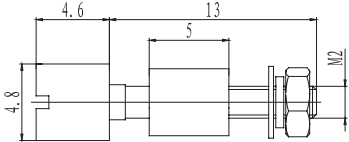
Blank—crimp contact J—solder cup
 S—straight to PCB,the column spacing of tail is 2.54mm
 S1—straight to PCB, the net grid spacing of tail is 2.54 X 2.54mm
 F—right angle to PCB, the net grid spacing of tail is 2.54X2.54mm
 FJ—right angle to PCB, the net grid spacing of tail is 1.27 X 2.54mm
 FM—right angle to PCB and surface mounting,only for middle locking connectors

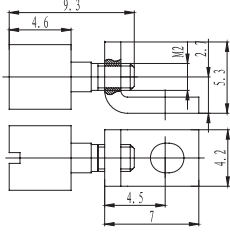
Accessories:

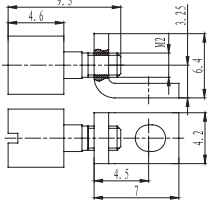
blank—without, more information please see page2

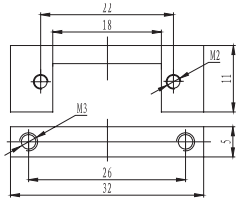
R04 Series Accessories

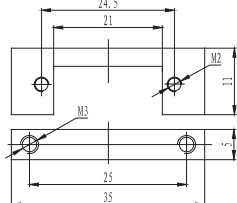
Type	Before assembling	Assembly Picture	Outerline Dimension	Feature and Matching Accessories
K01			Standard Accessories	<ol style="list-style-type: none"> 1. Screw post size:M2*6 2. Matching Accessories: K02, K03
K02				<ol style="list-style-type: none"> 1. Just suitable for front panel mountin 2. Matching Accessories : K01
K03				<ol style="list-style-type: none"> 1. Suitable for straight to pcb type connectors and pcb thickness not over 2.5mm. 2. Matching Accessories: K01
K04				<ol style="list-style-type: none"> 1. Suitable for R04-9, 15, 21 25, 31, 37PIF/PIFJ/ RHF/RHFJ 2. Matching Accessories: K01
K05				<ol style="list-style-type: none"> 1. Suitable for R04-51PIF/ PIFJ/ RHF/ RHFJ 2. Matching Accessories: K01
K06				<ol style="list-style-type: none"> 1. Suitable for R04-9, 15, 21 25, 31, 37PIF/PIFJ/ RHF/RHFJ 2. K06 include K01 locking screw post, but didn't show in the drawing
K07				<ol style="list-style-type: none"> 1. Suitable for R04-51PIF/ PIF-J/ RHF/ RHF-J 2. K07 include K01 locking screw post, but didn't show in the drawing

Note:All dimensions in mm

Product solid picture of crimp type



R04-31PI

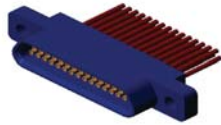

R04-31RH

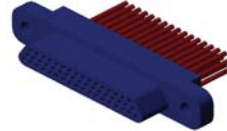

R04-51PI



R04-51RH

Outline dimension for sold cup and crimp type

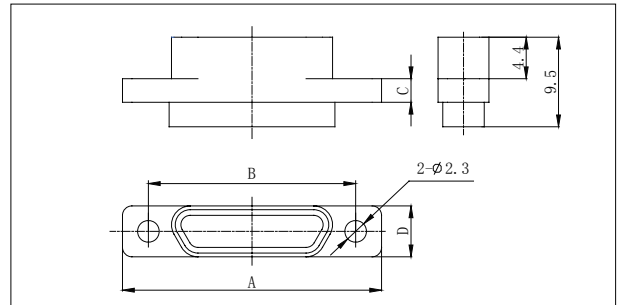
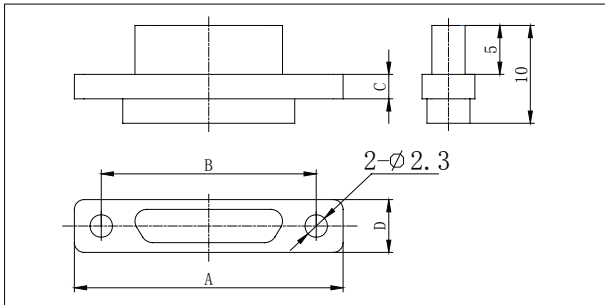

Part no.	A	B	C	D	Part no.	A	B	C	D
R04-9PI/9PIJ	19.8	14.3	2.5	5.4	R04-9RH/9RHJ	19.8	14.3	2.5	5.4
R04-15PI/15PIJ	23.6	18.2	2.5	5.4	R04-15RH/15RHJ	23.6	18.2	2.5	5.4
R04-21PI/21PIJ	27.5	22	2.5	5.4	R04-21RH/RHJ	27.5	22	2.5	5.4
R04-25PI/25PIJ	30	24.5	2.5	5.4	R04-25RH/25RHJ	30	24.5	2.5	5.4
R04-31PI/31PIJ	33.7	28.3	2.5	5.4	R04-31RH/31RHJ	33.7	28.3	2.5	5.4
R04-37PI/37PIJ	37.5	32.2	2.5	5.4	R04-37RH/37RHJ	37.5	32.2	2.5	5.4
R04-51PI/51PIJ	36.3	30.8	2.3	6.5	R04-51RH/51RHJ	36.3	30.8	2.3	6.5

Outline dimension after matching

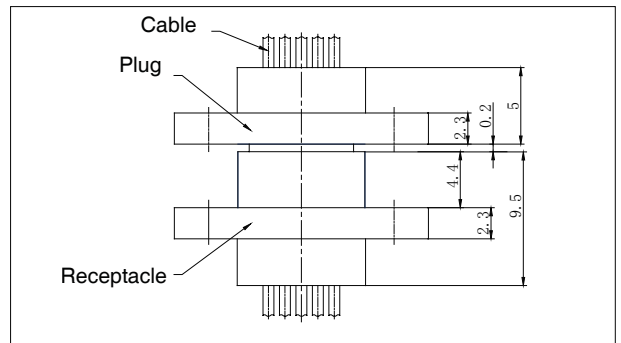
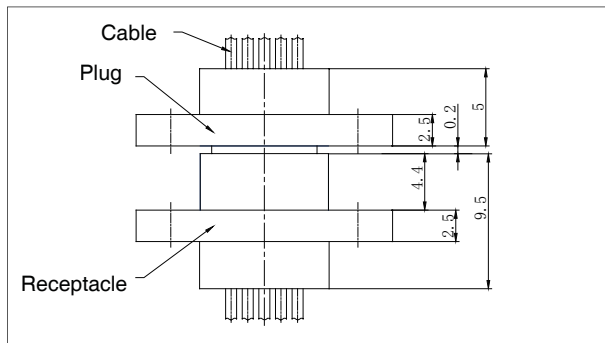

Note: All dimensions in mm

Product solid picture of straight to PCB (S type)



R04-21PIS



R04-21RHS



R04-51PIS



R04-51RHS

Outline dimension

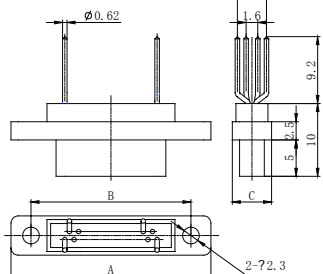

R04-9-37PIS

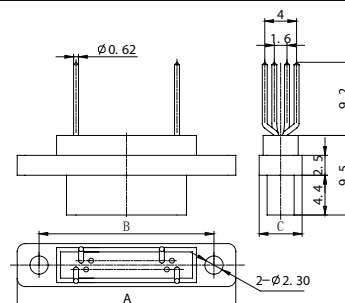

R04-9-37RHS

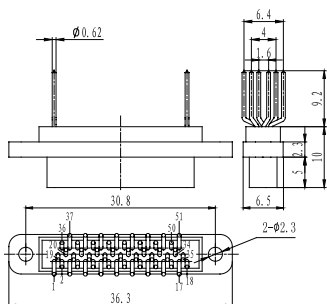

R04-51PIS

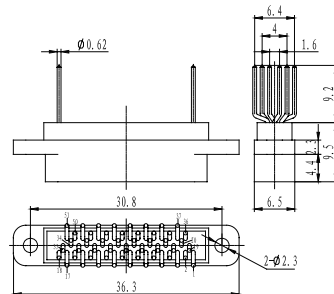

R04-51RHS

Part no.	A	B	C	Part no.	A	B	C
R04-9PIS	19.8	14.3	5.4	R04-9RHS	19.8	14.3	5.4
R04-15PIS	23.6	18.2	5.4	R04-15RHS	23.6	18.2	5.4
R04-21PIS	27.5	22	5.4	R04-21RHS	27.5	22	5.4
R04-25PIS	30	24.5	5.4	R04-25RHS	30	24.5	5.4
R04-31PIS	33.7	28.3	5.4	R04-31RHS	33.7	28.3	5.4
R04-37PIS	37.5	32.2	5.4	R04-37RHS	37.5	32.2	5.4

Note: All dimensions in mm

Product solid picture of straight to PCB (S1 type)



R04-25PIS1



R04-25RHS1



R04-51PIS1



R04-51RHS1

Outline dimension

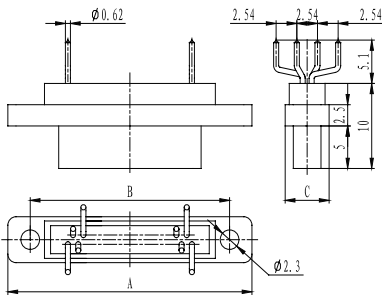

R04-9-37PIS1

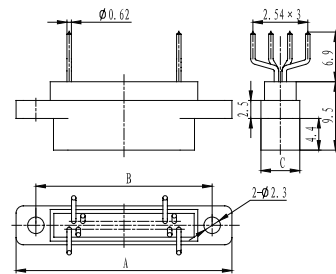

R04-9-37RHS1

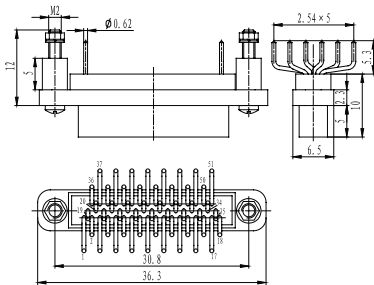

R04-51PIS1

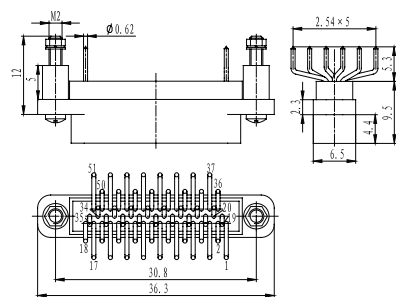

R04-51RHS1

Part no.	A	B	C	Part no.	A	B	C
R04-9PIS1	19.8	14.3	5.4	R04-9RHS1	19.8	14.3	5.4
R04-15PIS1	23.6	18.2	5.4	R04-15RHS1	23.6	18.2	5.4
R04-21PIS1	27.5	22	5.4	R04-21RHS1	27.5	22	5.4
R04-25PIS1	30	24.5	5.4	R04-25RHS1	30	24.5	5.4
R04-31PIS1	33.7	28.3	5.4	R04-31RHS1	33.7	28.3	5.4
R04-37PIS1	37.5	32.2	5.4	R04-37RHS1	37.5	32.2	5.4

Note: All dimensions in mm

Product solid picture of right angle to PCB(F type)



R04-31PIF



R04-31RHF

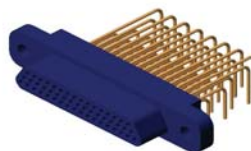

R04-51PIF



R04-51RHF

Outline dimension

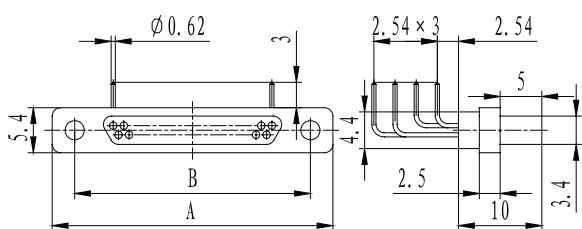

R04-9-37PIF

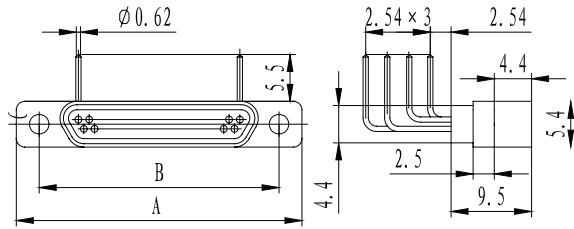

R04-9-37RHF

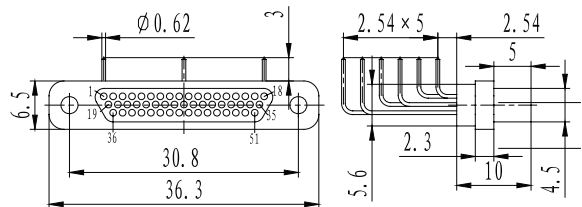

R04-51PIF

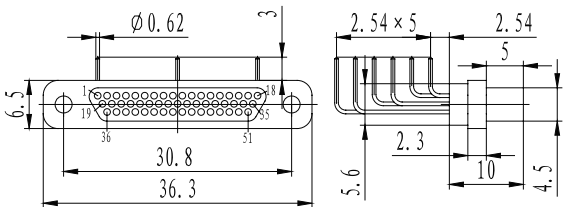

R04-51RHF

Part no.	A	B	Part no.	A	B
R04-9PIF	19.8	14.3	R04-9RHF	19.8	14.3
R04-15PIF	23.6	18.2	R04-15RHF	23.6	18.2
R04-21PIF	27.5	22	R04-21RHF	27.5	22
R04-25PIF	30	24.5	R04-25RHF	30	24.5
R04-31PIF	33.7	28.3	R04-31RHF	33.7	28.3
R04-37PIF	37.5	32.2	R04-37RHF	37.5	32.2

Note:All dimensions in mm

Product solid picture of right angle to PCB(FJ type)



R04-21PIFJ



R04-21RHFJ

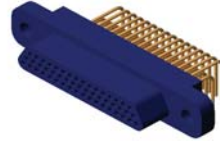

R04-51PIFJ



R04-51RHFJ

Outline dimension

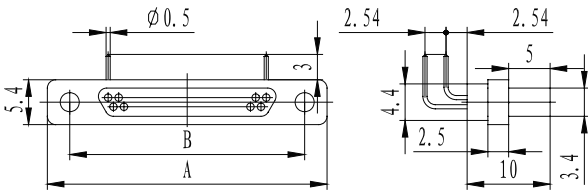

R04-9-37PIFJ

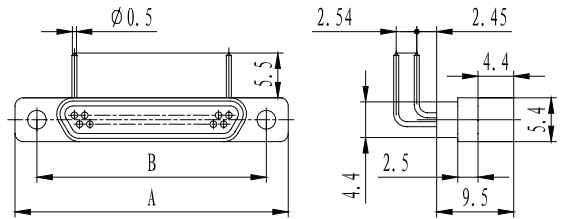

R04-9-37RHFJ

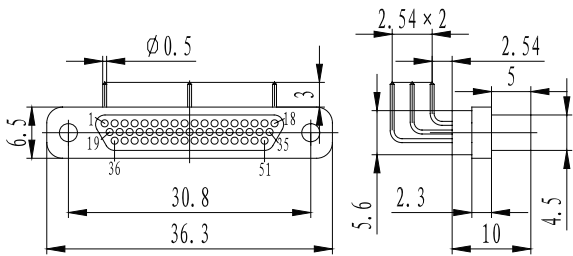

R04-51PIFJ

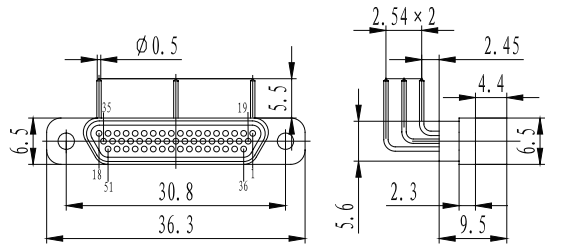

R04-51RHFJ

Part no.	A	B	Part no.	A	B
R04-9PIFJ/RHFJ	19.8	14.3	R04-25PIFJ/RHFJ	30	24.5
R04-15PIFJ/RHFJ	23.6	18.2	R04-31PIFJ/RHFJ	33.7	28.3
R04-21PIFJ/RHFJ	27.5	22	R04-37PIFJ/RHFJ	37.5	32.2

Note: All dimensions in mm

Product solid picture of middle locking connector

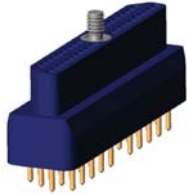

R04-38PIS

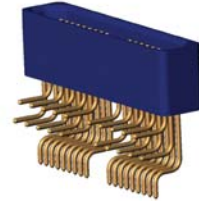

R04-38RHFM

Outline dimension

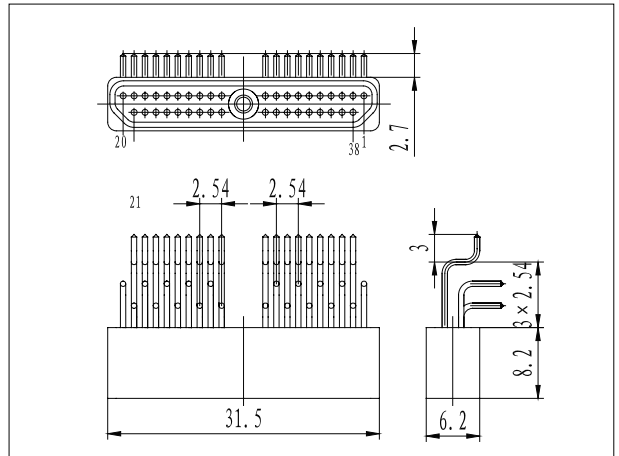
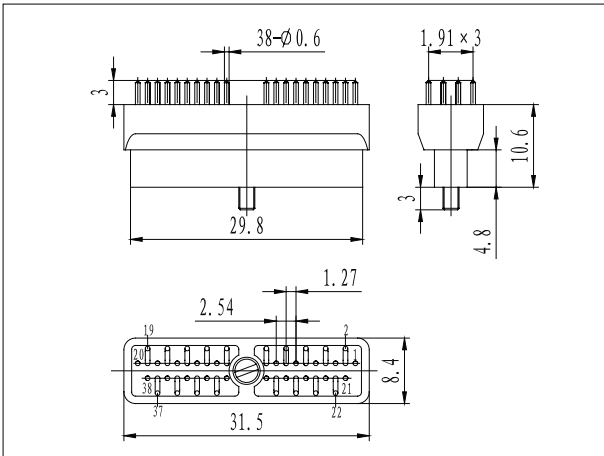

Mounting hole dimension of solder cup and crimp type

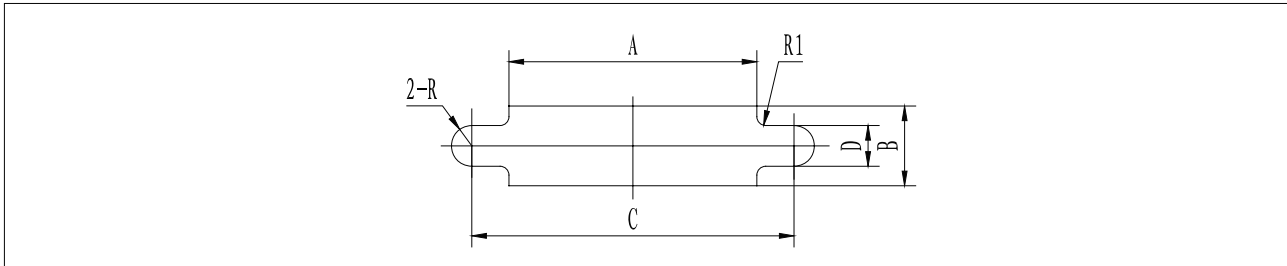

Contacts No.	A	B	C	D
9Pins	10.1	4.6	14.3	2.3
15Pins	14.2	4.6	18.2	2.3
21Pins	17.9	4.6	22	2.3
25Pins	20.8	4.6	24.5	2.3
31Pins	24.2	4.6	28.3	2.3
37Pins	28.2	4.6	32.2	2.3
51Pins	26.9	5.9	30.8	2.3

Note:All dimensions in mm

PCB layout of straight to PCB(S type)

■ R04-9PIS

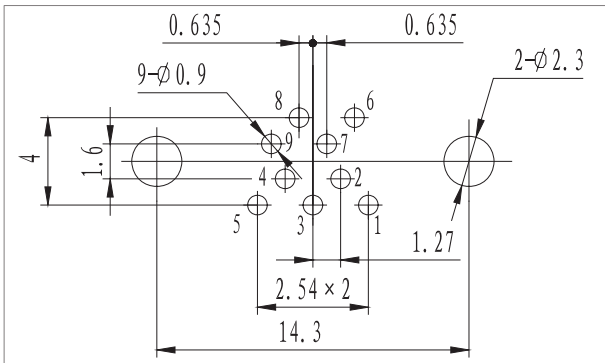

■ R04-9RHS

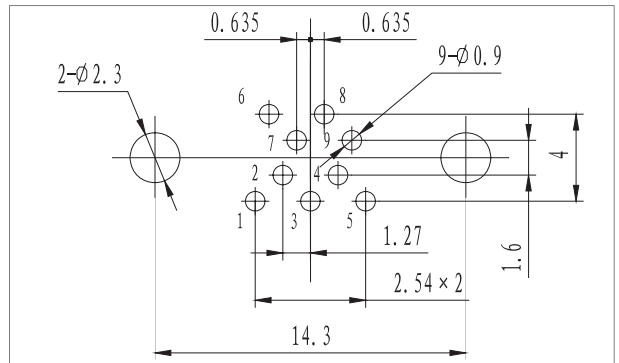

■ R04-15PIS

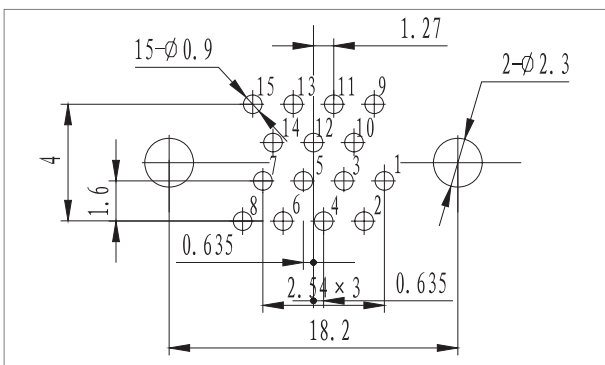

■ R04-15RHS

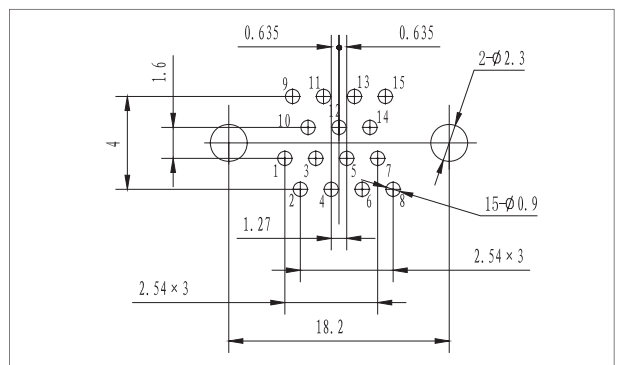

■ R04-21PIS

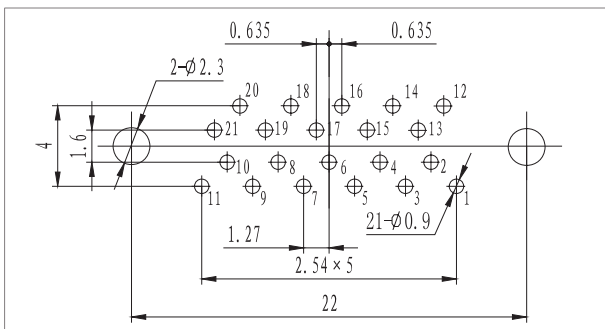

■ R04-21RHS

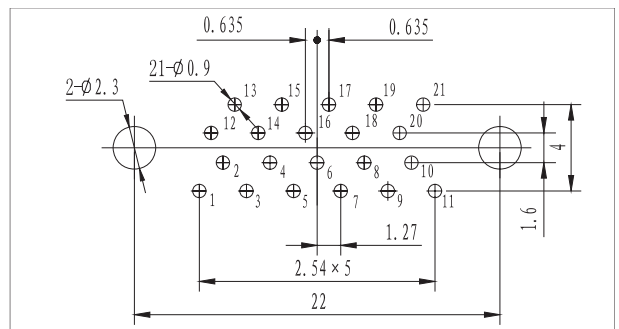

■ R04-25PIS

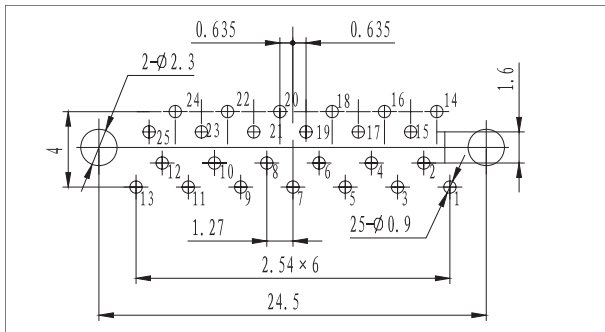

■ R04-25RHS

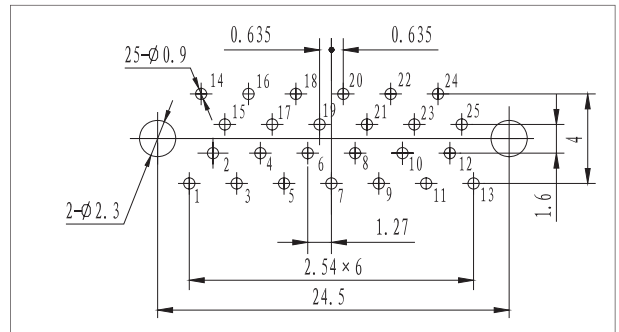

Note: All dimensions in mm



PCB layout of straight to PCB(S type)

■ R04-31PIS

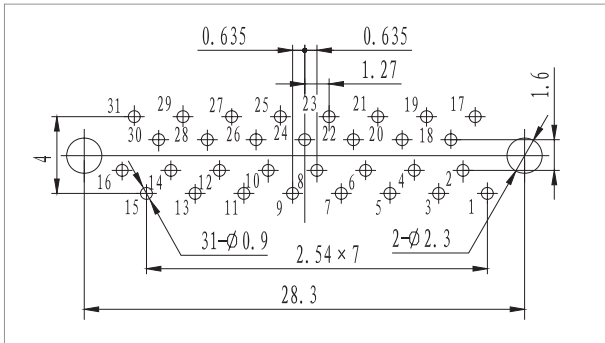

■ R04-31RHS

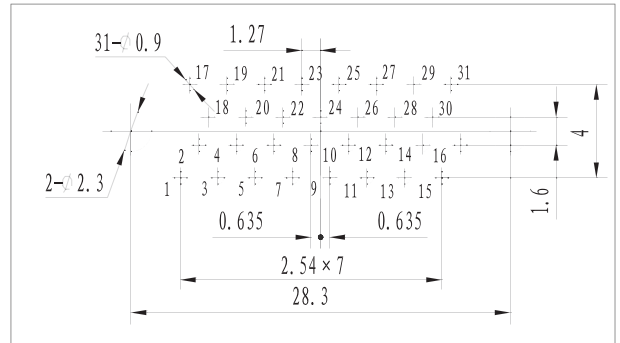

■ R04-37PIS

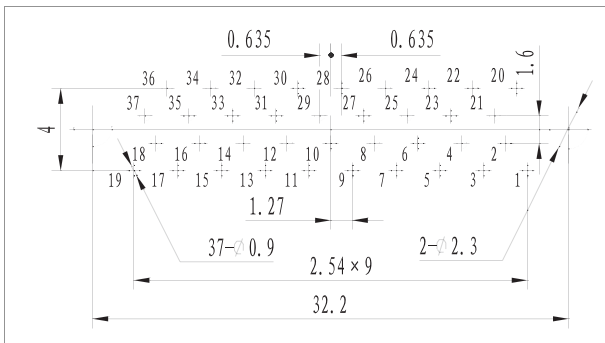

■ R04-37RHS

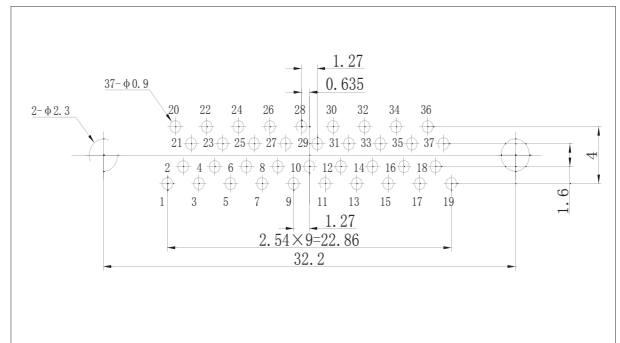

■ R04-51PIS

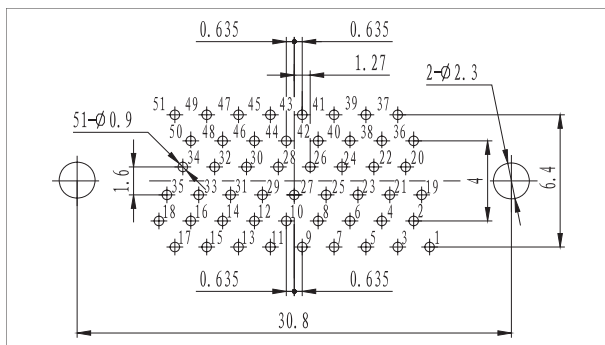

■ R04-51RHS

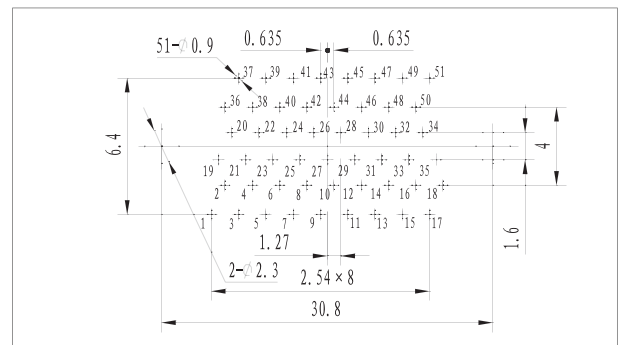

Note: All dimensions in mm

PCB layout of straight to PCB(S1 type)

■ R04-9PIS1

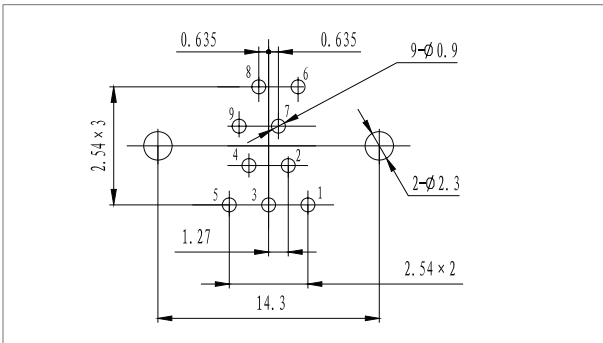

■ R04-9RHS1

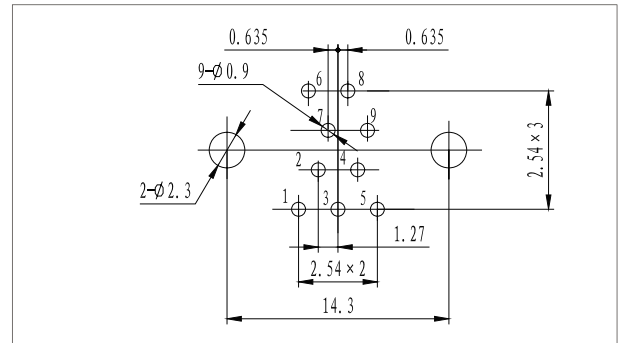

■ R04-15PIS1

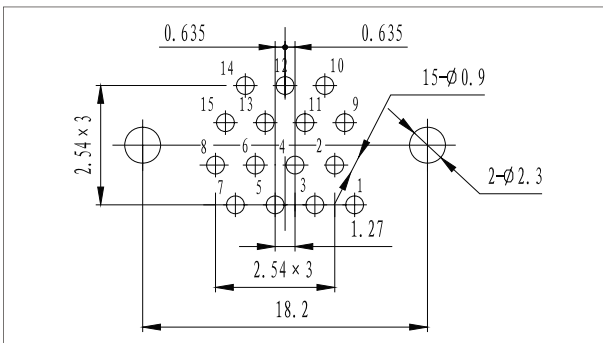

■ R04-15RHS1

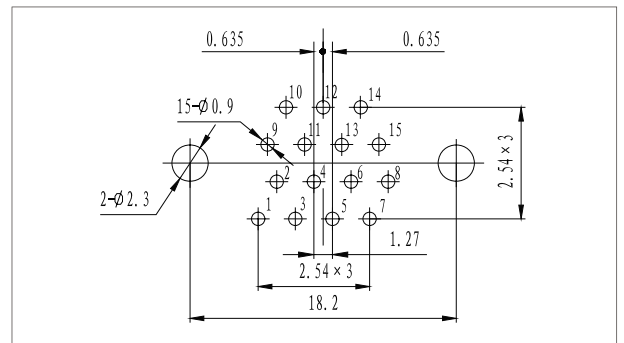

■ R04-21PIS1

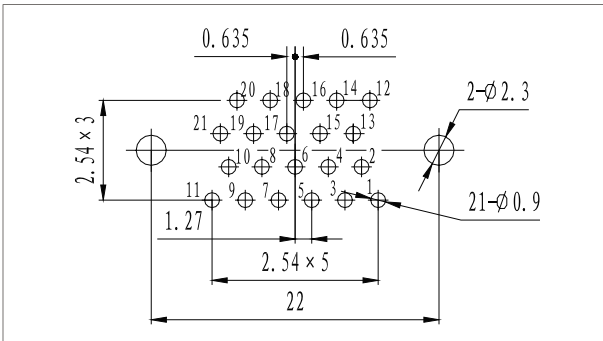

■ R04-21RHS1

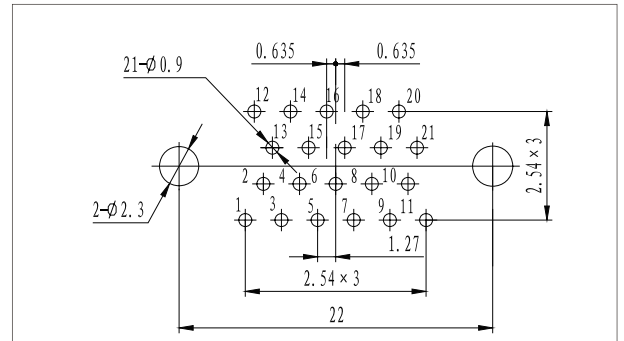

■ R04-25PIS1

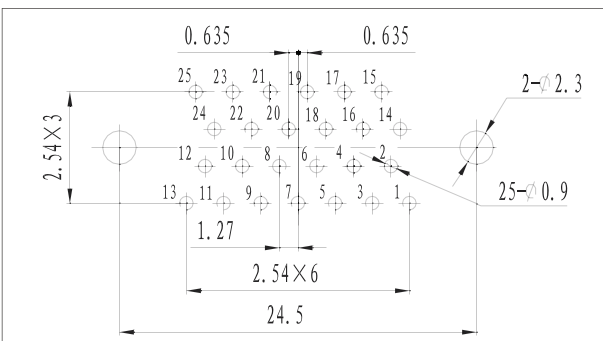

■ R04-25RHS1

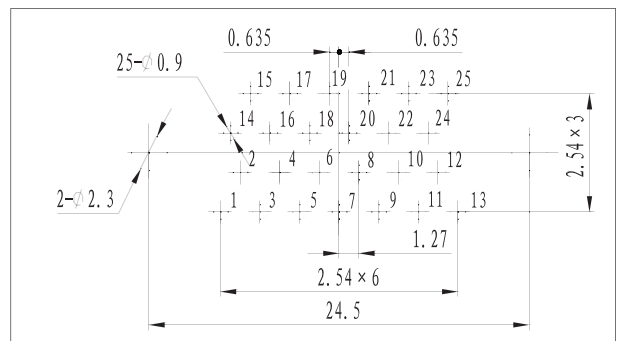

Note: All dimensions in mm

PCB layout of straight to PCB(S1 type)

■ R04-31PIS1

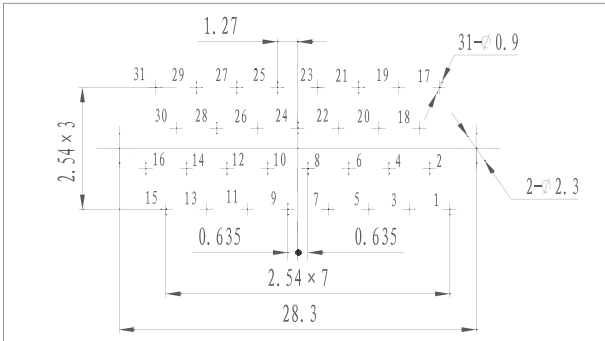

■ R04-31RHS1

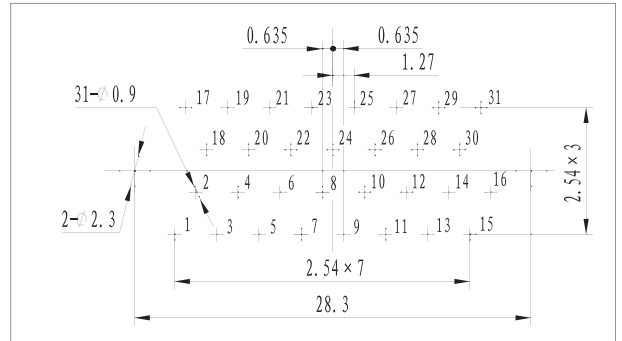

■ R04-37PIS1

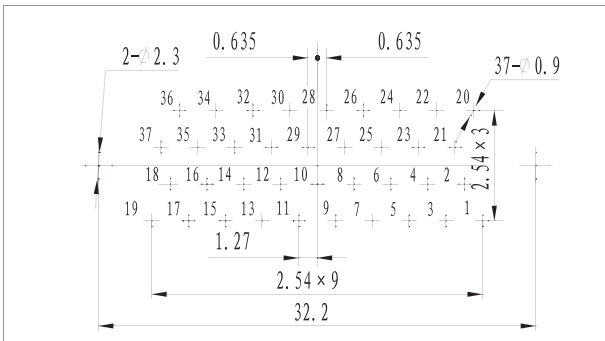

■ R04-37RHS1

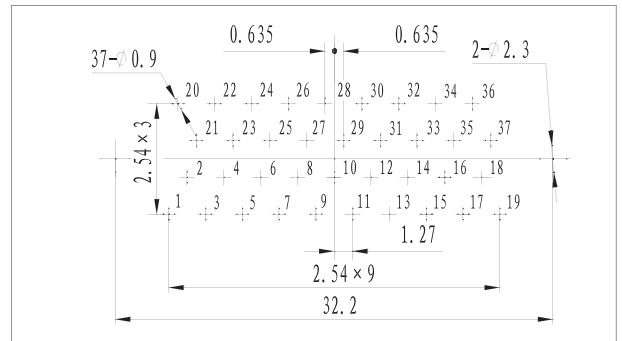

■ R04-51PIS1

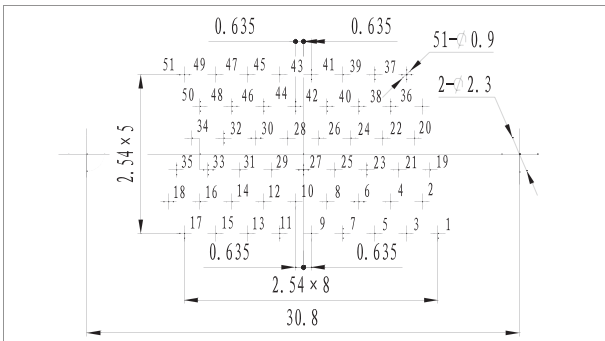

■ R04-51RHS1

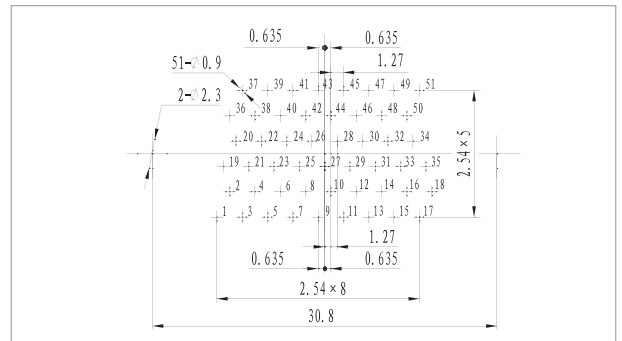

Note: All dimensions in mm

PCB layout of right angle to PCB (F type)

■ R04-9PIF

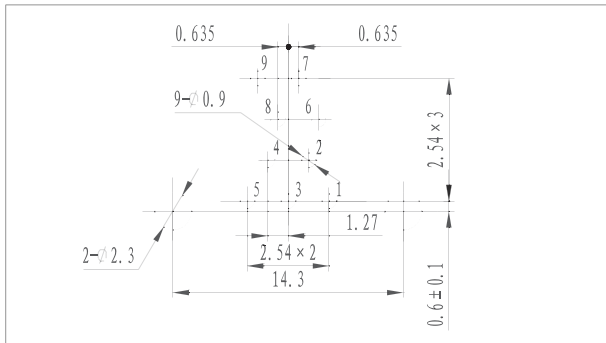

■ R04-9RHF

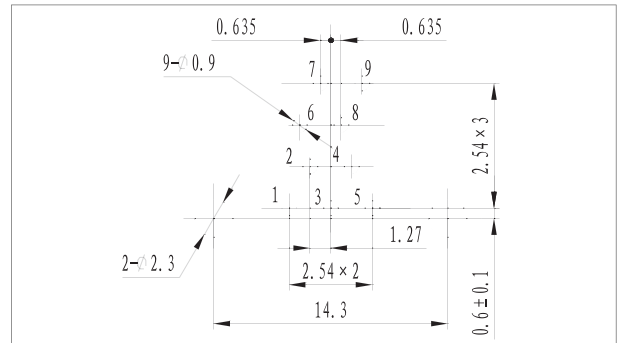

■ R04-15PIF

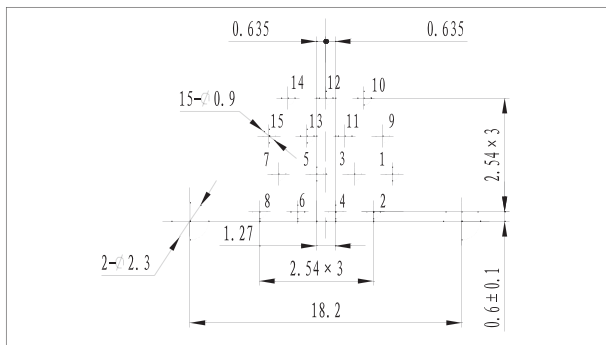

■ R04-15RHF

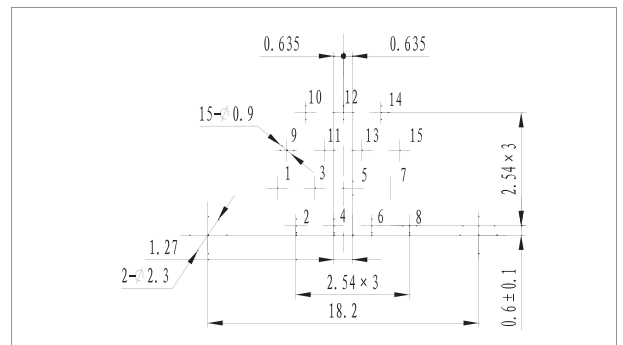

■ R04-21PIF

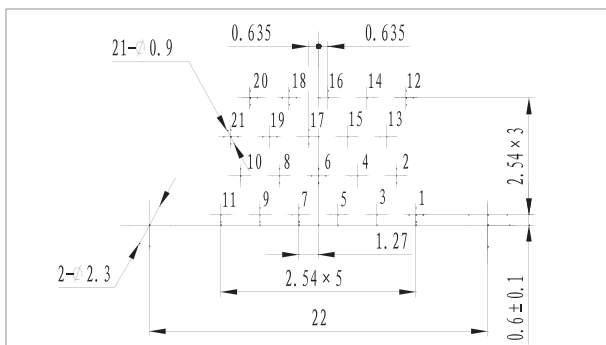

■ R04-21RHF

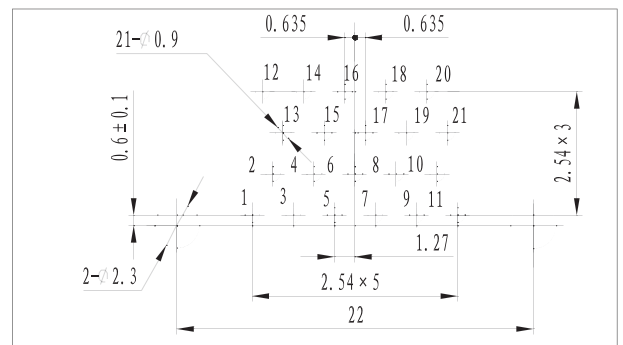

■ R04-25PIF

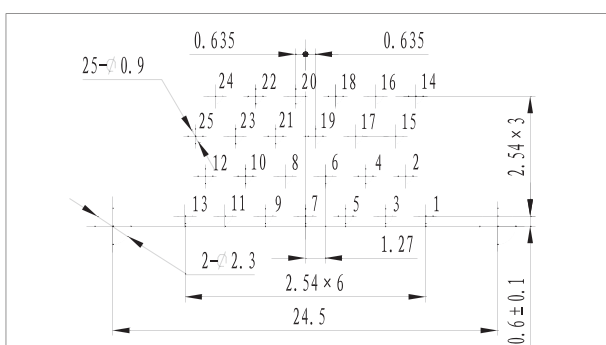

■ R04-25RHF

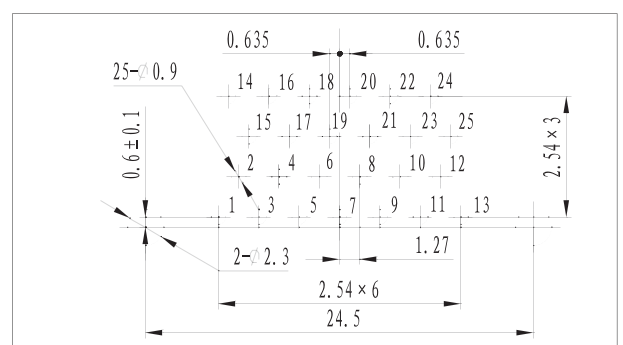

Note: All dimensions in mm

PCB layout of right angle to PCB (F type)

■ R04-31PIF

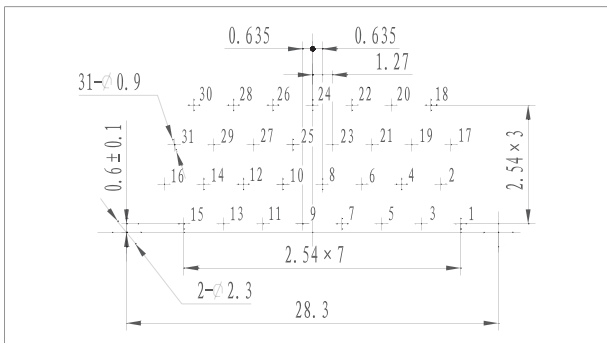

■ R04-31RHF

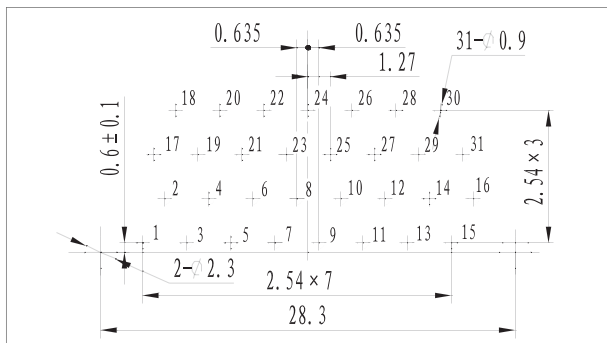

■ R04-37PIF

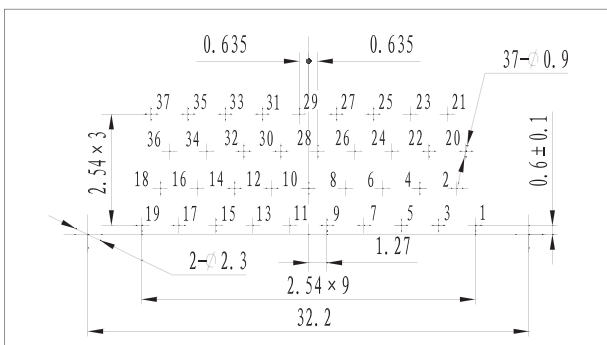

■ R04-37RHF

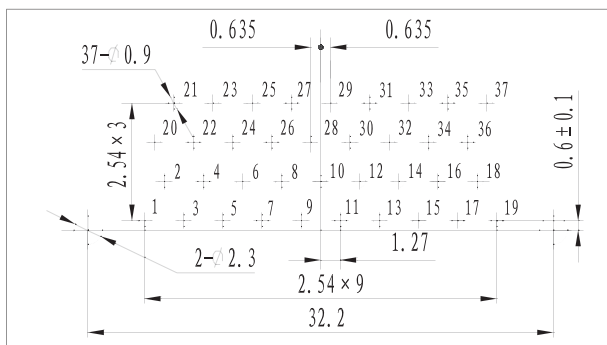

■ R04-51PIF

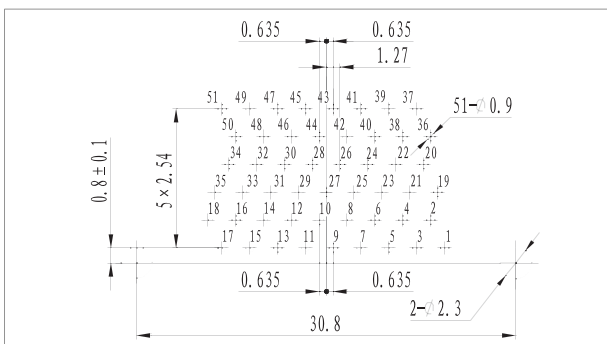

■ R04-51RHF

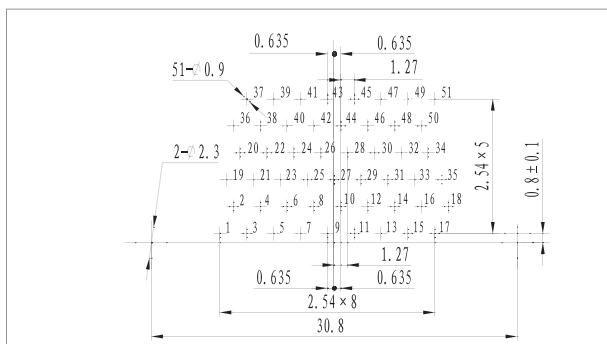

Note: All dimensions in mm

PCB layout of right angle to PCB (FJ type)

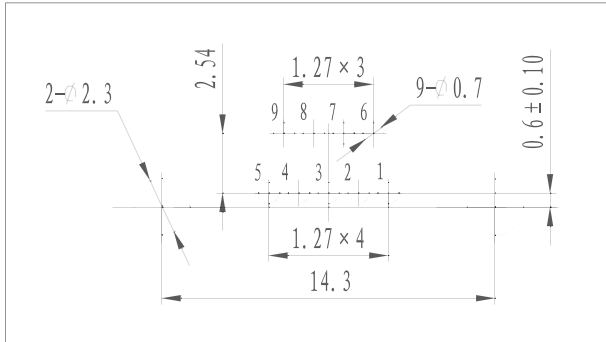

■ R04-15PIFJ

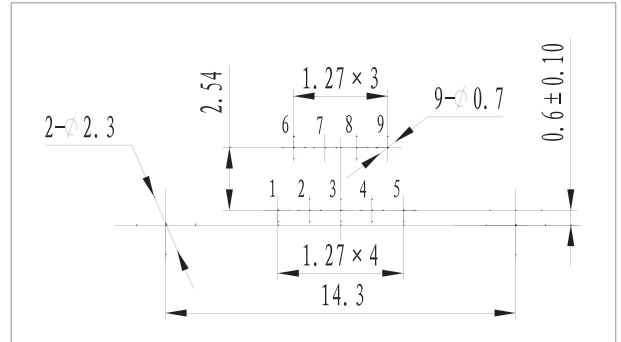

■ R04-15RHFJ

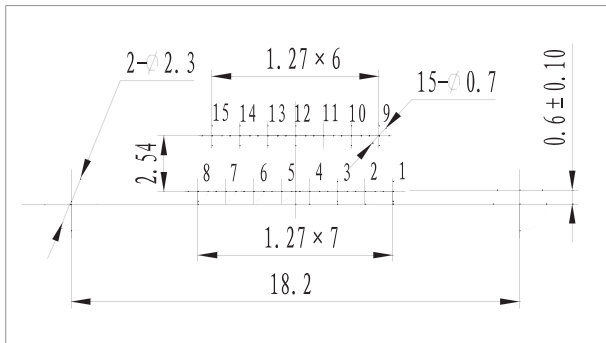

■ R04-21PIFJ

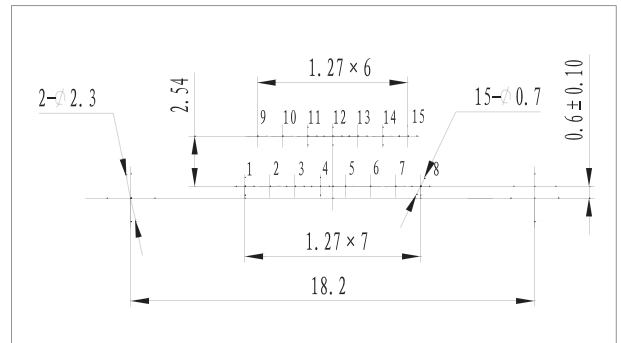

■ R04-21RHFJ

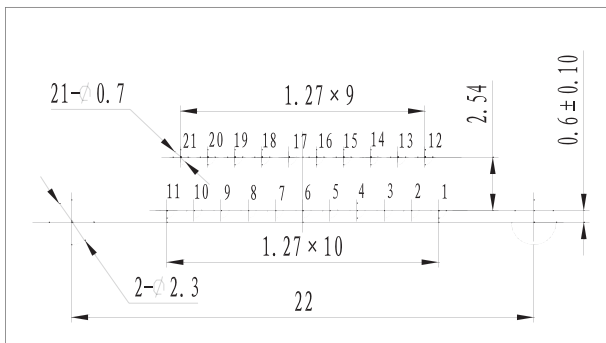

■ R04-25PIFJ

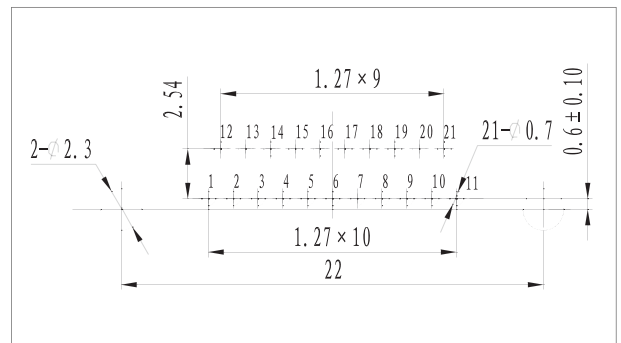

■ R04-25RHFJ

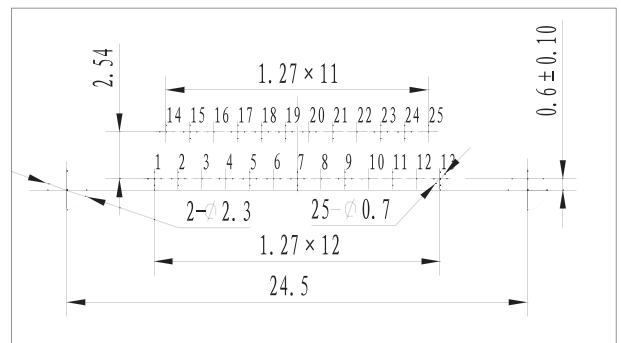
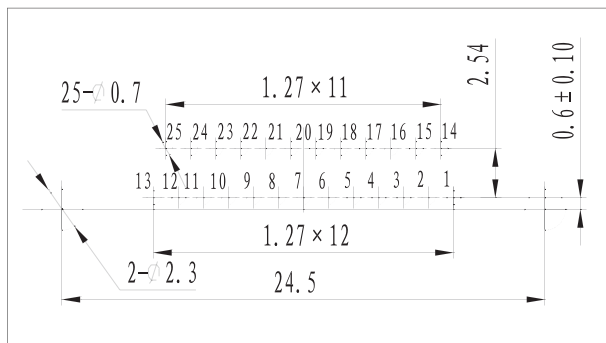

Note: All dimensions in mm

PCB layout of right angle to PCB (FJ type)

■ R04-31PIFJ

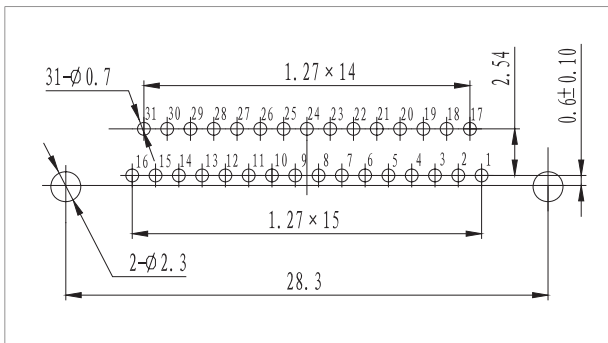

■ R04-31RHFJ

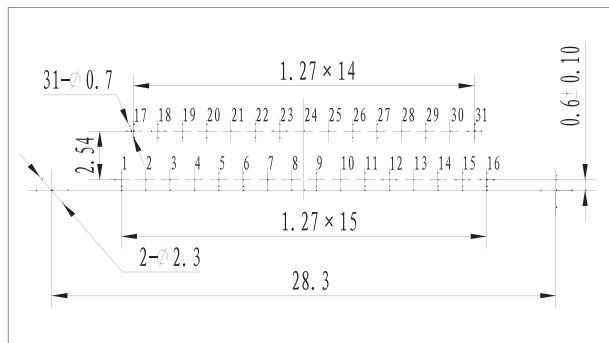

■ R04-37PIFJ

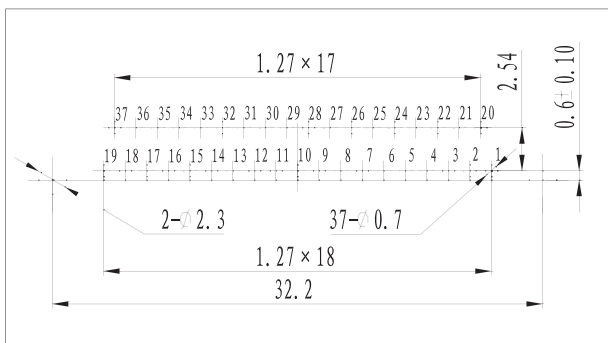

■ R04-37RHFJ

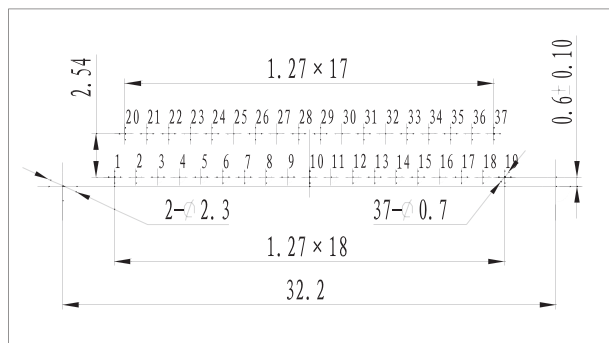

■ R04-51PIFJ

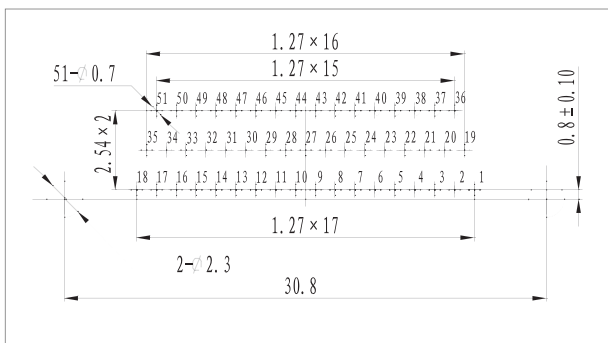

■ R04-51RHFJ

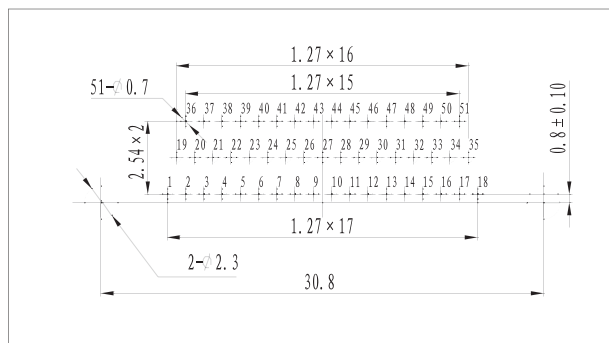

Note: All dimensions in mm