

PICMATES®

INTERCONNECT PRODUCTS

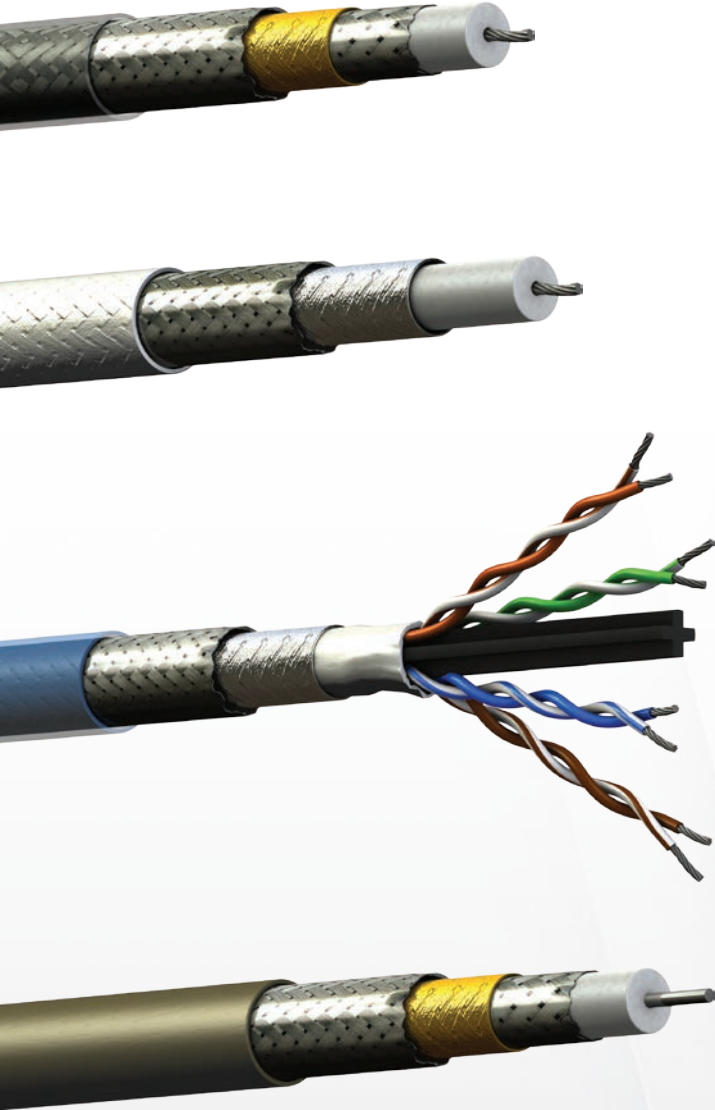

PRODUCT BINDER



PICMATES®

INTERCONNECT PRODUCTS



TABLE OF CONTENTS

PIC  **RF MATES®**

PIC  **RF MATES® ULTRALITE**

- 50 Ohm Cable Overview
- Lightweight RG Comparison Overview
- 50 Ohm ULTRALITE Coax
- 50 Ohm Low Loss Coax
- 50 Ohm High Loss Coax
- 50 Ohm Triaxial

1

PIC  **Video MATES®**

- 75 Ohm Cable Overview
- 75 Ohm SMPTE 259M Video (RG179 Replacement)
- 75 Ohm SMPTE 292M Video
- 75 Ohm SMPTE 424M Video

2

PIC  **Data MATES®**

- Ethernet Cable Overview
- Ethernet: 1 Pair, 2 Pair, 4 Pair and Quadaxial
- Power Over Ethernet (PoE)
- USB Cable Overview
- USB: 2.0 and 3.1
- ARINC 429
- MIL-STD 1553
- CANbus and ASCB
- Fiber Channel
- Honeywell Lightning Sensor
- Stormscope

3

PIC  **Micro MATES®**

- High Frequency Cable Overview
- 50 Ohm X and Ku Band Assemblies

4

**Connectors &
Cable Assemblies**

- Connectors Overview
- RF Adapters
- QUAD Connector™
- Cable Assemblies Overview
- Cable Assemblies Example Test Report

5

Additional Information

- 50 Ohm Cable Comparison
- Application Notes
- Technical Articles
- Avionics Systems

6

PIC
WIRE & CABLE

A Division of The Angelus Corporation

**QUALITY
TECHNOLOGY
SERVICE**



Using the latest technologies and materials, PIC Wire & Cable's® 50 ohm coaxial and triaxial cables are designed and manufactured to meet the most stringent electrical and mechanical performance criteria required for advanced electronic applications including lightweight, low loss, high flexibility, high EMI immunity, high temperature and high corrosion resistance. All are Skydrol resistant, RoHS compliant, meet the FAA flammability requirements of FAR Part 23 and 25, Appendix F and comply with MIL-C-17 as applicable.

For over 45 years, PIC Wire & Cable has been a global provider of electronic cables, cable connectors and cable assemblies for demanding military, corporate and commercial applications that include airplanes, helicopters, ground vehicles, rail transport and marine vessels. PIC cables, connectors and cable assemblies are widely specified for use in major aerospace and military systems throughout the world.

Navigation:

- DME • GPS
- Radio Altimeter
- VOR
- Marker Beacon

Collision Avoidance:

- TCAS • TAS
- ACAS • Mode S
- Skywatch
- ADS-B

Communications:

- HF • VHF • UHF
- AirCell
- Cellular
- Satcom

50 OHM RF CABLE SOLUTIONS

Physical and Electrical Data

All values nominal unless otherwise noted

Coaxial Cable	Conductor	Loss @ 1.0 GHz dB/100 ft (dB/100 m)	Cable O.D. in (mm)	Weight lbs/100 ft (kg/100 m)	Temperature Range (°C)	Shielding Effectiveness (dB)
S22089	10 AWG Stranded	3.5 (11.5)	0.44 (11.05)	18.0 (26.8)	-55/+200	-90
S55122	12 AWG Stranded	5.1 (16.7)	0.31 (7.87)	8.3 (12.4)	-55/+200	-90
S33141	14 AWG Stranded	6.7 (22.0)	0.27 (6.86)	6.5 (9.7)	-55/+200	-90
S67163	15 AWG Solid	7.0 (23.0)	0.23 (5.72)	5.4 (8.0)	-55/+200	-90
S65161-A	16 AWG Stranded	8.2 (26.9)	0.20 (4.95)	3.5 (5.2)	-65/+200	-110
S44193	19 AWG Solid	11.1 (36.4)	0.20 (4.95)	4.3 (6.4)	-55/+200	-90
S44191	20 AWG Stranded	11.8 (38.7)	0.20 (4.95)	4.3 (6.4)	-55/+200	-90
S88207	20 AWG Solid	12.8 (42.0)	0.13 (3.30)	1.9 (2.8)	-55/+200	-80
S86208	21 AWG Stranded	14.1 (46.3)	0.13 (3.30)	2.0 (2.9)	-55/+200	-80
S40501	24 AWG Solid	19.4 (63.6)	0.10 (2.54)	1.4 (2.1)	-55/+200	-110
S46191	20 AWG Stranded	22.3 (73.2)	0.20 (4.95)	2.7 (4.0)	-55/+150	-75
S31601	26 AWG Stranded	26.3 (86.3)	0.10 (2.54)	1.0 (1.5)	-55/+200	-90
Triaxial Cable						
L8620TX	21 AWG Stranded	15.1 (49.5)	0.17 (4.39)	2.9 (4.3)	-55/+150	-90
L2201TX	20 AWG Stranded	20.4 (66.9)	0.25 (6.22)	6.0 (8.9)	-55/+150	-75

PIC RF MATES® ULTRALITE



COMPARE PIC CABLES TO RG CABLES

**80% LIGHTER
SAVE 14LBS/100FT**

RG393



PIC UH67163



- REDUCED OPERATING COST
- INCREASED PAYLOAD CAPACITY
- LOWER LOSS-HIGHER EMI IMMUNITY
- SMALLER BEND RADIUS

ULTRALITE 50 OHM RF CABLE SOLUTIONS

NEXT GENERATION **LITEWEIGHT** RF COAXIAL CABLES COMPARE CABLE LOSS AND WEIGHT SAVINGS

Physical and Electrical Data

All values nominal unless otherwise noted

Coaxial Cable	Conductor	Loss @ 1.0 GHz dB/100 ft (dB/100 m)	Weight lbs/100 ft (kg/100 m)	Bend Radius in (mm)	Cable O.D. in (mm)	Temperature Range (°C)	Shielding Effectiveness (dB)
UH25107	8 AWG Solid SPCCA	2.8 (9.2)	12.0 (17.9)	2.50 (63.5)	0.44 (11.30)	-65/+150	-110
UH22089	10 AWG Solid SPCCA	3.5 (11.5)	7.2 (10.7)	1.70 (43.18)	0.34 (8.76)	-65/+150	-110
UH67163	14 AWG Solid SPCCA	6.2 (20.3)	3.4 (5.1)	1.20 (30.48)	0.22 (5.76)	-65/+150	-110
UH44193	19 AWG Solid SPCCS	10.4 (34.1)	1.9 (2.9)	0.80 (20.32)	0.15 (3.86)	-65/+150	-110
RG211	4 AWG Solid BC	4.5 (14.8)	64.1 (95.4)	3.6 (91.44)	0.73 (18.54)	-55/+250	-50
RG393	12 AWG Stranded SPC	7.7 (25.2)	17.5 (26.4)	1.95 (49.53)	0.39 (9.90)	-55/+200	-75
RG142	19 AWG Solid SPCCS	13.4 (44.0)	4.3 (6.4)	1.00 (25.40)	0.19 (4.95)	-55/+200	-75

Materials Key: BC – Bare Copper; SPC – Silver-Plated Copper; SPCCS – Silver-Plated Copper Clad Steel; SPCCA – Silver-Plated Copper Clad Aluminum



Addressing the growing demand and need for lighter weight interconnects, we have expanded our RFMATES® line of 50 ohm cables with four Ultralite selections. All are Skydrol resistant, RoHS compliant, meet the FAA flammability requirements of FAR Part 23 and 25, Appendix F and comply with MIL-C-17 as applicable. In addition, they are designed and manufactured to meet the most stringent electrical and mechanical performance criteria required for advanced electronic applications including low loss, high flexibility, high EMI immunity, high temperature & high corrosion resistance.

Our RFMATES® cables, connectors and assemblies are widely specified for use in major aerospace and military systems worldwide, including:

Navigation:

- DME • GPS
- Radio Altimeter
- VOR
- Marker Beacon

Collision Avoidance:

- TCAS • TAS
- ACAS • Mode S
- Skywatch
- ADS-B

Communications:

- HF • VHF • UHF
- AirCell
- Cellular
- Satcom

LIGHTWEIGHT CABLE APPLICATIONS

Physical and Electrical Data

All values nominal unless otherwise noted

Cable	Loss @ 1.0 GHz dB/100 ft (dB/100 m)	Weight lbs/100 ft (kg/100 m)	Bend Radius in (mm)	Cable O.D. in (mm)	Shielding Effectiveness (dB)
UH25107	2.8 (9.2)	12 (17.9)	2.50 (63.50)	0.445 (11.303)	-110
RG211	4.5 (14.8)	64.1 (95.4)	3.6 (91.44)	0.730 (18.542)	-50
UH22089	3.5 (11.5)	7.2 (10.7)	1.70 (43.18)	0.345 (8.763)	-110
S22089	3.5 (11.5)	18.0 (26.8)	2.50 (63.50)	0.435 (11.049)	-90
S55122	5.1 (16.7)	8.3 (12.4)	1.55 (39.37)	0.310 (7.874)	-90
UH67163	6.2 (20.3)	3.4 (5.1)	1.20 (30.48)	0.227 (5.766)	-110
S33141	6.7 (22.0)	6.5 (9.7)	1.40 (35.56)	0.270 (6.858)	-90
S67163	7.0 (23.0)	5.4 (8.0)	1.20 (30.48)	0.225 (5.715)	-90
RG393	7.7 (25.2)	17.5 (26.4)	1.95 (49.53)	0.390 (9.906)	-75
S65161-A	8.2 (26.9)	3.5 (5.2)	1.00 (25.40)	0.195 (4.953)	-110
UH44193	10.4 (34.1)	1.9 (2.9)	0.80 (20.32)	0.152 (3.861)	-110
S44193	11.1 (36.4)	4.3 (6.4)	1.00 (25.40)	0.195 (4.953)	-90
S44191	11.8 (38.7)	4.3 (6.4)	1.00 (25.40)	0.195 (4.953)	-90
S88207	12.8 (42.0)	1.9 (2.8)	0.65 (16.51)	0.130 (3.302)	-80
RG142	13.4 (44.0)	4.3 (6.4)	1.00 (25.40)	0.195 (4.953)	-75
S86208	14.1 (46.3)	2.0 (2.9)	0.65 (16.51)	0.130 (3.302)	-80
RG400	17.0 (55.8)	5.0 (7.4)	1.00 (25.40)	0.195 (4.953)	-75

CABLE CONSTRUCTION

1. SPCCA Center Conductor
2. PTFE Dielectric
3. SPC Spiral Shield
4. SPCCA Braided Shield
5. ETFE Jacket (White) Laser Markable

This ultra lightweight, low loss, flexible 50 ohm cable provides major weight and loss savings over traditional RG cables. UH25107 features a construction design that can save 60% or more in cable weight. This cable is well-suited for systems that have a low dB loss budget for antenna runs, such as SATCOM and Iridium systems.

UH25107 has a Silver Plated Copper Clad Aluminum center conductor and outer braid. It has a spiral (helical) wrap Silver Plated Copper inner shield, which provides shielding effectiveness (RF leakage) down to -110 dB min, which is the same as a RG405 semi-rigid coaxial cable with a solid copper tube. This shield also conforms to the low loss dielectric for superior uniformity, which results in low signal reflections (VSWR) and low attenuation.

It is Skydrol resistant, RoHS compliant, and has a white laser-markable jacket that meets the FAA FAR 25 burn requirements and exceeds the AIRBUS and BOEING fire requirements.

PIC  **RF MATES**[®] **ULTRALITE**

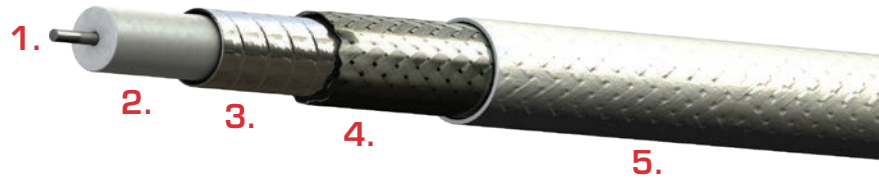

PHYSICAL DATA

- Conductor 08 AWG Solid SPCCA
- Operating Temperature -65° to +150°C
- Maximum Temperature -65° to +200°C
- Outer Diameter: in (mm) 0.445 (11.30)
- Minimum Bend Radius: in (mm) 2.50 (63.50)
- Weight: lbs/100 ft (kg/100 m) 12 (17.9)

ELECTRICAL DATA

- Impedance: ohms 50
- Capacitance: pF/ft (m) 25.0 (82.0)
- Velocity of Propagation: % 82.0
- Time Delay: ns/ft (m) 1.22 (4.00)
- RF Shielding Effectiveness: dB/min -110
- DC Resistance: ohms/1000 ft (m) 1.1 (3.6)
- Attenuation: Nom / Max dB/100 ft (dB/100 m)
 - @400 MHz 1.7 / 1.9 (5.6 / 6.2)
 - @1.0 GHz 2.8 / 3.1 (9.2 / 10.2)
 - @1.6 GHz 3.6 / 4.0 (11.8 / 13.1)
 - @5.0 GHz 7.0 / 7.8 (23.0 / 25.6)
- K Values (nom loss): K1 = 2.50, K2 = 0.29
- Formula for Attenuation: $(K1 * \sqrt{F(GHz)}) + (K2 * F(GHz))$

All values nominal unless otherwise noted

PIC P/N **CONNECTOR TYPE**

ARINC

190401	600 Size 1
190402	600 Modified Size 1

M39012

PIC P/N **CONNECTOR TYPE**

190412	BNC Straight Plug
190413	BNC 90° Plug
190406	C Straight Plug
190407	C 90° Plug
190410	N Straight Plug
190411	N 90° Plug
190424	N Inline Jack
190422	N Bulkhead Jack
190408	TNC Straight Plug
190409	TNC 90° Plug
190423	TNC Inline Jack
190421	TNC Bulkhead Jack

*Die Sets Available On Loan Or For Purchase From PIC
Refer To Connector Drawing For Tooling
Call PIC For Availability*

CABLE CONSTRUCTION

1. SPCCA Center Conductor
2. PTFE Dielectric
3. SPC Spiral Shield
4. SPCCA Braided Shield
5. ETFE Jacket (White) Laser Markable

This ultra lightweight and flexible cable has a silver-plated copper clad aluminum (SPCCA) center conductor and braided shield. Our next generation of light weight cable is more than 30% lighter than cables of similar size and 60% lighter than S22089. It is laser-markable, easy to terminate, and easily assembled in the field.

UH22089 is 100% shielded construction, incorporating a flat spiral wrapped shield which achieves -110 dB shielding effectiveness, same as a solid copper tube. The inner spiral shield conforms to the low-loss PTFE dielectric for superior uniformity and stability of all operating parameters, initially and over time.

It is Skydrol resistant, RoHS compliant and meets the FAA flammability requirements 14 CFR Part 25.869 (a)(4) Amdt 25-113 Appendix F Part 1 (a)(3); complies with MIL-C-17 as applicable.

PIC  **RF MATES**[®] **ULTRALITE**



PHYSICAL DATA

- Conductor 10 AWG Solid SPCCA
- Operating Temperature -65° to +150°C
- Maximum Temperature -65° to +200°C
- Outer Diameter: in (mm) 0.345 (8.76)
- Minimum Bend Radius: in (mm) 1.70 (43.18)
- Weight: lbs/100 ft (kg/100 m) 7.2 (10.7)

ELECTRICAL DATA

- Impedance: ohms 50
- Capacitance: pF/ft (m) 24.0 (78.7)
- Velocity of Propagation: % 83
- Time Delay: ns/ft (m) 1.22 (4.00)
- RF Shielding Effectiveness: dB/min -110
- DC Resistance: ohms/1000 ft (m) 2.00 (6.56)
- Attenuation: Nom / Max dB/100 ft (dB/100 m)
 - @400 MHz 2.2 / 2.4 (7.2 / 7.9)
 - @1.0 GHz 3.5 / 3.9 (11.5 / 12.8)
 - @1.6 GHz 4.4 / 4.9 (14.4 / 16.1)
 - @5.0 GHz 8.1 / 9.0 (26.6 / 29.5)
- K Values (nom loss): K1 = 3.31, K2 = 0.135
- Formula for Attenuation: $(K1 * \sqrt{F(GHz)}) + (K2 * F(GHz))$

All values nominal unless otherwise noted

PIC P/N **CONNECTOR TYPE**

ARINC

150401	600 Size 1
150402	600 Modified Size 1

M39012

PIC P/N	CONNECTOR TYPE	PIC P/N	CONNECTOR TYPE
150412	BNC Straight Plug	150414	SMA Straight Plug
150413	BNC 90° Plug	150415	SMA 90° Plug
150406	C Straight Plug	150408	TNC Straight Plug
150407	C 90° Plug	150409	TNC 90° Plug
150410	N Straight Plug	150409-L	TNC 90° Plug (Long)
150411	N 90° Plug	150421	TNC Bulkhead Jack
150422	N Bulkhead Jack		

*Die Sets Available On Loan Or For Purchase From PIC
Refer To Connector Drawing For Tooling
Call PIC For Availability*

CABLE CONSTRUCTION

1. SPCCA Center Conductor
2. PTFE Dielectric
3. SPC Spiral Shield
4. SPCCA Braided Shield
5. ETFE Jacket (White) Laser Markable

This ultra lightweight and flexible cable has a silver-plated copper clad aluminum (SPCCA) center conductor and braided shield. Our next generation of light weight cable is more than 30% lighter than cables of similar size and 80% lighter & lower loss than RG393. It is laser-markable, easy to terminate, and easily assembled in the field.

UH67163 is 100% shielded construction, incorporating a flat spiral wrapped shield which achieves -110 dB shielding effectiveness, same as a solid copper tube. The inner spiral shield conforms to the low-loss PTFE dielectric for superior uniformity and stability of all operating parameters, initially and over time.

It is Skydrol resistant, RoHS compliant and meets the FAA flammability requirements 14 CFR Part 25.869 (a)(4) Amdt 25-113 Appendix F Part 1 (a)(3); complies with MIL-C-17 as applicable.

PIC  **RF MATES**[®] **ULTRALITE**



PHYSICAL DATA

- Conductor 14 AWG Solid SPCCA
- Operating Temperature -65° to +150°C
- Maximum Temperature -65° to +200°C
- Outer Diameter: in (mm) 0.227 (5.77)
- Minimum Bend Radius: in (mm) 1.20 (30.48)
- Weight: lbs/100 ft (kg/100 m) 3.4 (5.1)

ELECTRICAL DATA

- Impedance: ohms 50
- Capacitance: pF/ft (m) 24.7 (81.0)
- Velocity of Propagation: % 83
- Time Delay: ns/ft (m) 1.22 (4.00)
- RF Shielding Effectiveness: dB/min -110
- DC Resistance: ohms/1000 ft (m) 4.10 (13.46)
- Attenuation: Nom / Max dB/100 ft (dB/100 m)
 - @400 MHz 3.9 / 4.3 (12.8 / 14.1)
 - @1.0 GHz 6.2 / 6.8 (20.3 / 22.3)
 - @1.6 GHz 7.9 / 8.7 (25.9 / 28.5)
 - @5.0 GHz 14.3 / 15.9 (46.9 / 52.2)
- K Values (nom loss): K1 = 5.90, K2 = 0.216
- Formula for Attenuation: $(K1 * \sqrt{F(GHz)}) + (K2 * F(GHz))$

All values nominal unless otherwise noted

PIC P/N **CONNECTOR TYPE**

ARINC

150501	600 Size 1
150502	600 Modified Size 1
150503	600 Size 5

M39029 for MIL-C-38999 Connector

150538	Size 8 Pin
150539	Size 8 Socket

Special Purpose

150520	Rockwell ProLine Avionics Coaxial Socket
---------------	---

M39012

PIC P/N	CONNECTOR TYPE	PIC P/N	CONNECTOR TYPE
150512	BNC Straight Plug	150549	QMA Straight Plug
150513	BNC 90° Plug	150550	QMA 90° Plug
150513-L	BNC 90° Plug (Long)		
150504	HN Straight Plug	150514	SMA Straight Plug
150505	HN 90° Plug	150515	SMA 90° Plug
		150525	SMA Inline Jack
150510	N Straight Plug	150508	TNC Straight Plug
150511	N 90° Plug	150509	TNC 90° Plug
150522	N Bulkhead Jack	150509-L	TNC 90° Plug (Long)
150569	SC Straight Plug	150521	TNC Bulkhead Jack
		150523	TNC Inline Jack

*Die Sets Available On Loan Or For Purchase From PIC
Refer To Connector Drawing For Tooling
Call PIC For Availability*

CABLE CONSTRUCTION

1. SPCCS Center Conductor
2. PTFE Dielectric
3. SPC Spiral Shield
4. SPCCA Braided Shield
5. ETFE Jacket (White) Laser Markable

This ultra lightweight and flexible cable has a silver-plated copper clad aluminum (SPCCA) braided shield. Our next generation of light weight cable is more than 30% lighter than cables of similar size and 56% lighter & significantly lower loss than RG400/142. It is laser-markable, easy to terminate, and easily assembled in the field.

UH44193 is 100% shielded construction, incorporating a flat spiral wrapped shield which achieves -110 dB shielding effectiveness, same as a solid copper tube. The inner spiral shield conforms to the low-loss PTFE dielectric for superior uniformity and stability of all operating parameters, initially and over time.

It is Skydrol resistant, RoHS compliant and meets the FAA flammability requirements 14 CFR Part 25.869 (a)(4) Amdt 25-113 Appendix F Part 1 (a)(3); complies with MIL-C-17 as applicable.

PIC  **RF MATES**[®] ULTRALITE



PHYSICAL DATA

• Conductor	19 AWG Solid SPCCS
• Operating Temperature	-65° to +150°C
• Maximum Temperature	-65° to +200°C
• Outer Diameter: in (mm)	0.155 (3.94)
• Minimum Bend Radius: in (mm)	0.80 (20.32)
• Weight: lbs/100 ft (kg/100 m)	1.9 (2.9)

ELECTRICAL DATA

• Impedance: ohms	50	
• Capacitance: pF/ft (m)	27.0 (88.6)	
• Velocity of Propagation: %	77	
• Time Delay: ns/ft (m)	1.32 (4.33)	
• RF Shielding Effectiveness: dB/min	-110	
• DC Resistance: ohms/1000 ft (m)	19.1 (62.7)	
• Attenuation: Nom / Max	dB/100 ft	(dB/100 m)
• @400 MHz	6.5 / 7.3	(21.3 / 23.9)
• @1.0 GHz	10.4 / 11.6	(34.1 / 38.1)
• @1.6 GHz	13.3 / 14.8	(43.6 / 48.6)
• @5.0 GHz	24.3 / 27.0	(79.7 / 88.6)
• K Values (nom loss):	K1 = 10.07, K2 = 0.342	
• Formula for Attenuation:	$(K1 * \sqrt{F(GHz)}) + (K2 * F(GHz))$	

All values nominal unless otherwise noted

PIC P/N **CONNECTOR TYPE**

ARINC

150101	600 Size 1
150102	600 Modified Size 1
150103	600 Size 5
150129	Size 8 Socket

D-SUB

150163	Size 8 Pin
150164	Size 8 Socket

M39029 for MIL-C-38999 Connector

150138	Size 8 Pin
150139	Size 8 Socket

Special Purpose

150120	Rockwell ProLine Avionics Coaxial Socket
--------	--

M39012

PIC P/N	CONNECTOR TYPE	PIC P/N	CONNECTOR TYPE
150112	BNC Straight Plug	150110	N Straight Plug
150113	BNC 90° Plug	150111	N 90° Plug
150113-L	BNC 90° Plug (Long)	150122	N Bulkhead Jack
150128	BNC Bulkhead Jack	150114	SMA Straight Plug
150106	C Straight Plug	150115	SMA 90° Plug
150107	C 90° Plug	150108	TNC Straight Plug
		150109	TNC 90° Plug
		150121	TNC Bulkhead Jack

*Die Sets Available On Loan Or For Purchase From PIC
Refer To Connector Drawing For Tooling
Call PIC For Availability*

CABLE CONSTRUCTION

1. Fluoropolymer Teflon® Jacket (Clear)
2. Silver-Plated Copper Shield
3. Aluminum / Polyimide Shield
4. Silver-Plated Copper Flat Strip Braid
5. PTFE Dielectric
6. Silver-Plated Copper Conductor

This cable is particularly suitable for GPS, TCAS, Mode-S, MLS and SATCOM installations.

This special coaxial design incorporates a multi-layered shielding technique that combines conventional shields with an inner shield woven of flat strips of silver plated copper. This “unitized” shield reduces attenuation at frequencies over 1 GHz when compared to round wire braids in standard coaxial cables. Additionally, the cable VSWR is lower because the braids can be applied more uniformly. The attenuation and VSWR variation due to aging and flexure is substantially less.

It is Skydrol resistant, RoHS compliant and meets the FAA flammability requirements of FAR Part 23 and 25, Appendix F; complies with MIL-C-17.



PHYSICAL DATA

- Conductor 10 AWG Stranded SPC
- Operating Temperature -55° to +200°C
- Outer Diameter: in (mm) 0.435 (11.05)
- Minimum Bend Radius: in (mm) 2.50 (63.50)
- Weight: lbs/100 ft (kg/100 m) 18.0 (26.8)

ELECTRICAL DATA

- Impedance: ohms 50
- Capacitance: pF/ft (m) 25.5 (83.7)
- Velocity of Propagation: % 82.5
- Time Delay: ns/ft (m) 1.23 (4.04)
- RF Shielding Effectiveness: dB/min -90
- DC Resistance: ohms/1000 ft (m) 0.8 (2.5)
- Attenuation: Nom / Max dB/100 ft (dB/100 m)
 - @400 MHz 2.2 / 2.4 (7.2 / 7.9)
 - @1.0 GHz 3.5 / 3.9 (11.5 / 12.8)
 - @1.6 GHz 4.5 / 5.0 (14.8 / 16.4)
 - @5.0 GHz 8.3 / 9.1 (27.2 / 29.9)
- K Values (nom loss): K1 = 0.105, K2 = 0.0001674
- Formula for Attenuation: $(K1 * \sqrt{F(MHz)}) + (K2 * F(MHz))$

All values nominal unless otherwise noted

PIC P/N **CONNECTOR TYPE**

ARINC

190401	600 Size 1
190402	600 Modified Size 1

M39012

PIC P/N **CONNECTOR TYPE**

190412	BNC Straight Plug
190413	BNC 90° Plug
190406	C Straight Plug
190407	C 90° Plug
190410	N Straight Plug
190411	N 90° Plug
190424	N Inline Jack
190422	N Bulkhead Jack
190408	TNC Straight Plug
190409	TNC 90° Plug
190423	TNC Inline Jack
190421	TNC Bulkhead Jack

*Die Sets Available On Loan Or For Purchase From PIC
Refer To Connector Drawing For Tooling
Call PIC For Availability*

CABLE CONSTRUCTION

1. Fluoropolymer Jacket (Clear)
2. Silver-Plated Copper Shield
3. Aluminum / Polyimide Shield
4. Silver-Plated Copper Flat Strip Braid
5. PTFE Dielectric
6. Silver-Plated Copper Conductor



This cable is particularly suitable for GPS, TCAS, Mode-S, MLS and SATCOM installations.

This special coaxial design incorporates a multi-layered shielding technique that combines conventional shields with an inner shield woven of flat strips of silver plated copper. This “unitized” shield reduces attenuation at frequencies over 1 GHz when compared to round wire braids in standard coaxial cables.

Additionally, the cable VSWR is lower because the braids can be applied more uniformly. The attenuation and VSWR variation due to aging and flexure is substantially less.

It is Skydrol resistant, RoHS compliant and meets the FAA flammability requirements of FAR Part 23 and 25, Appendix F; complies with MIL-C-17 as applicable.

PHYSICAL DATA

- Conductor 12 AWG Stranded SPC
- Operating Temperature -55 to +200°C
- Outer Diameter: in (mm) 0.31 (7.87)
- Minimum Bend Radius: in (mm) 1.55 (39.37)
- Weight: lbs/100 ft (kg/100 m) 8.3 (12.4)

ELECTRICAL DATA

- Impedance: ohms 50
- Capacitance: pF/ft (m) 24.0 (78.7)
- Velocity of Propagation: % 84.5
- Time Delay: ns/ft (m) 1.21 (3.97)
- RF Shielding Effectiveness: dB/min -90
- DC Resistance: ohms/1000 ft (m) 1.6 (5.3)
- Attenuation: Nom / Max dB/100 ft (dB/100 m)
 - @400 MHz 3.2 / 3.5 (10.5 / 11.5)
 - @1.0 GHz 5.1 / 5.6 (16.7 / 18.4)
 - @1.6 GHz 6.5 / 7.2 (21.3 / 23.6)
 - @5.0 GHz 12.0 / 13.2 (39.4 / 43.3)
- K Values (nom loss): K1 = 0.155, K2 = 0.000199
- Formula for Attenuation: $(K1 * \sqrt{F(MHz)}) + (K2 * F(MHz))$

All values nominal unless otherwise noted

PIC P/N **CONNECTOR TYPE**

ARINC

190619	404 Size 1
190601	600 Size 1
190602	600 Modified Size 1

M39012

PIC P/N	CONNECTOR TYPE	PIC P/N	CONNECTOR TYPE
190612	BNC Straight Plug	190614	SMA Straight Plug
190613	BNC 90° Plug	190615	SMA 90° Plug
190606	C Straight Plug	190625	SMA Inline Jack
190607	C 90° Plug	190608	TNC Straight Plug
190604	HN Straight Plug	190609	TNC 90° Plug
190605	HN 90° Plug	190631	TNC 75° Plug
190610	N Straight Plug	190623	TNC Inline Jack
190611	N 90° Plug	190621	TNC Bulkhead Jack
190622	N Bulkhead Jack		

*Die Sets Available On Loan Or For Purchase From PIC
Refer To Connector Drawing For Tooling
Call PIC For Availability*

CABLE CONSTRUCTION

1. Fluoropolymer Jacket (Clear)
2. Silver-Plated Copper Shield
3. Aluminum / Polyimide Shield
4. Silver-Plated Copper Flat Strip Braid
5. PTFE Dielectric
6. Silver-Plated Copper Conductor



This cable is particularly suitable for GPS, TCAS, Mode-S, MLS and SATCOM installations. It is lower loss, more flexible and less than half the weight of RG214 and less than one third the weight of RG393.

This special coaxial design incorporates a multi-layered shielding technique that combines conventional shields with an inner shield woven of flat strips of silver plated copper. This "unitized" shield reduces attenuation at frequencies over 1 GHz when compared to round wire braids in standard coaxial cables. Additionally, the cable VSWR is lower because the braids can be applied more uniformly. The attenuation and VSWR variation due to aging and flexure is substantially less.

It is Skydrol resistant, RoHS compliant and meets the FAA flammability requirements of FAR Part 23 and 25, Appendix F; complies with MIL-C-17 as applicable.

Note: This product is also available with an orange fluoropolymer jacket under product number S34141.

PHYSICAL DATA

• Conductor	14 AWG Stranded SPC
• Operating Temperature	-55° to +200°C
• Outer Diameter: in (mm)	0.27 (6.86)
• Minimum Bend Radius: in (mm)	1.40 (35.56)
• Weight: lbs/100 ft (kg/100 m)	6.5 (9.7)

ELECTRICAL DATA

• Impedance: ohms	50	
• Capacitance: pF/ft (m)	25.0 (82.0)	
• Velocity of Propagation: %	80.5	
• Time Delay: ns/ft (m)	1.26 (4.13)	
• RF Shielding Effectiveness: dB/min	-90	
• DC Resistance: ohms/1000 ft (m)	2.9 (9.5)	
• Attenuation: Nom / Max	dB/100 ft	(dB/100 m)
• @400 MHz	4.2 / 4.7	(13.8 / 14.4)
• @1.0 GHz	6.7 / 7.4	(22.0 / 24.3)
• @1.6 GHz	8.6 / 9.5	(28.2 / 31.2)
• @5.0 GHz	15.5 / 17.1	(50.9 / 56.1)
• K Values (nom loss):	K1 = 0.207, K2 = 0.0001785	
• Formula for Attenuation:	$(K1 * \sqrt{F(MHz)}) + (K2 * F(MHz))$	

All values nominal unless otherwise noted

PIC P/N **CONNECTOR TYPE**

ARINC

190319	404 Size 1
190301	600 Size 1
190302	600 Modified Size 1
190303	404/600 Size 5
190329	Size 8 Socket

M39029 for MIL-C-38999 Connector

190338	Size 8 Pin
190339	Size 8 Socket

M39012

PIC P/N	CONNECTOR TYPE	PIC P/N	CONNECTOR TYPE
190312	BNC Straight Plug	190314	SMA Straight Plug
190313	BNC 90° Plug	190315	SMA 90° Plug
190327	BNC Inline Jack	190308	TNC Straight Plug
190306	C Straight Plug	190309	TNC 90° Plug
190307	C 90° Plug	190331	TNC 75° Plug
190304	HN Straight Plug	190323	TNC Inline Jack
190305	HN 90° Plug	190321	TNC Bulkhead Jack
190310	N Straight Plug		
190311	N 90° Plug		
190324	N Inline Jack		
190322	N Bulkhead Jack		

*Die Sets Available On Loan Or For Purchase From PIC
Refer To Connector Drawing For Tooling
Call PIC For Availability*

CABLE CONSTRUCTION

1. Fluoropolymer Jacket (Clear)
2. Silver-Plated Copper Shield
3. Aluminum / Polyimide Shield
4. Silver-Plated Copper Flat Strip Braid
5. PTFE Dielectric
6. Silver-Plated Copper Conductor



This cable is particularly suitable for GPS, TCAS, MLS, Mode S and SATCOM installations. It is dimensionally identical to RG400, but has lower loss and improved shielding.

This special coaxial design incorporates a multi-layered shielding technique that combines conventional shields with an inner braid woven of flat strips of silver plated copper. This "unitized" shield reduces attenuation at frequencies over 1 GHz when compared to round wire braids in standard coaxial cables. Additionally, the cable VSWR is lower because the braids can be applied more uniformly. The attenuation and VSWR variation due to aging and flexure is substantially less.

S44191 can be terminated with standard RG142/RG400 connectors.

It is Skydrol resistant, RoHS compliant and meets the FAA flammability requirements of FAR Part 23 and 25, Appendix F; complies with MIL-C-17 as applicable.

PHYSICAL DATA

• Conductor	20 AWG Stranded SPC
• Operating Temperature	-55° to +200°C
• Outer Diameter: in (mm)	0.20 (4.95)
• Minimum Bend Radius: in (mm)	1.00 (25.40)
• Weight: lbs/100 ft (kg/100 m)	4.3 (6.4)

ELECTRICAL DATA

• Impedance: ohms	50	
• Capacitance: pF/ft (m)	29.3 (96.2)	
• Velocity of Propagation: %	69.5	
• Time Delay: ns/ft (m)	1.46 (4.79)	
• RF Shielding Effectiveness: dB/min	-90	
• DC Resistance: ohms/1000 ft (m)	8.6 (28.2)	
• Attenuation: Nom / Max	dB/100 ft	(dB/100 m)
• @400 MHz	7.3 / 8.0	(23.9 / 26.2)
• @1.0 GHz	11.8 / 13.0	(38.7 / 42.7)
• @1.6 GHz	15.2 / 16.8	(49.9 / 55.1)
• @5.0 GHz	28.5 / 31.4	(93.5 / 103.0)
• K Values (nom loss):	K1 = 0.35, K2 = 0.00075	
• Formula for Attenuation:	$(K1 * \sqrt{F(MHz)}) + (K2 * F(MHz))$	

All values nominal unless otherwise noted

PIC P/N **CONNECTOR TYPE**

ARINC

190119	404 Size 1
190101	600 Size 1
190102	600 Modified Size 1
110123	404/600 Size 5

M39012

PIC P/N	CONNECTOR TYPE	PIC P/N	CONNECTOR TYPE
190112	BNC Straight Plug	110576	QMA Straight Plug
190113	BNC 90° Plug	110577	QMA 90° Plug
190127	BNC Inline Jack	110198	SMA Straight Plug
110193	BNC Bulkhead Jack	110207	SMA 90° Plug
190106	C Straight Plug	190108	TNC Straight Plug
190107	C 90° Plug	190109	TNC 90° Plug
190104	HN Straight Plug	190131	TNC 75° Plug
190105	HN 90° Plug	190123	TNC Inline Jack
190110	N Straight Plug	190121	TNC Bulkhead Jack
190111	N 90° Plug		
110087	N Bulkhead Jack		

Also fit PIC P/N S44193, RG142 and RG400

*Die Sets Available On Loan Or For Purchase From PIC
Refer To Connector Drawing For Tooling
Call PIC For Availability*

CABLE CONSTRUCTION

1. Fluoropolymer Jacket (Clear)
2. Silver-Plated Copper Shield
3. Silver-Plated Copper Strip Braid
4. PTFE Dielectric
5. Silver-Plated Copper Conductor



Designed as a lightweight replacement for M17/128-RG400, S86208 is two-thirds the diameter and less than half the weight — 20 lbs vs 43 lbs per 1,000 ft. for RG400. This is accomplished through the use of a low-loss PTFE expanded-tape dielectric between the center conductor and the shield. In addition, the inner braid is a silver-plated copper strip braid, offering improved shielding and greater strength than conventional wire braid.

Attenuation figures are approximately 20% better than RG400. A fluoropolymer jacket protects the cable against abrasion and environmental effects while maintaining flexibility for ease of installation.

S86208 has been approved by Honeywell for the Apex/Epic System. It is Skydrol resistant, RoHS compliant and meets the FAA flammability requirements of FAR Part 23 and 25, Appendix F; complies with MIL-C-17 as applicable.

PHYSICAL DATA

• Conductor	21 AWG Stranded SPC
• Operating Temperature	-55° to +200°C
• Outer Diameter: in (mm)	0.13 (3.30)
• Minimum Bend Radius: in (mm)	0.65 (16.51)
• Weight: lbs/100 ft (kg/100 m)	2.0 (2.9)

ELECTRICAL DATA

• Impedance: ohms	50
• Capacitance: pF/ft (m)	25.0 (82.0)
• Velocity of Propagation: %	80.0
• Time Delay: ns/ft (m)	1.27 (4.17)
• RF Shielding Effectiveness: dB/min	-80
• DC Resistance: ohms/1000 ft (m)	11.6 (38.1)
• Attenuation: Nom / Max	dB/100 ft (dB/100 m)
• @400 MHz	8.9 / 9.8 (29.2 / 32.2)
• @1.0 GHz	14.1 / 15.5 (46.3 / 50.9)
• @1.6 GHz	17.9 / 19.7 (58.7 / 64.6)
• @5.0 GHz	32.0 / 35.2 (105.0 / 115.5)
• K Values (nom loss):	K1 = 0.44, K2 = 0.000179
• Formula for Attenuation:	$(K1 * \sqrt{F(MHz)}) + (K2 * F(MHz))$

All values nominal unless otherwise noted

PIC P/N	CONNECTOR TYPE	PIC P/N	CONNECTOR TYPE
ARINC			
190819	404 Size 1	190803	404/600 Size 5
190801	600 Size 1	190837	Size 8 Pin
190802	600 Modified Size 1	190829	Size 8 Socket

D-SUB			
110286	Size 8 Pin		
111113	Precision 50 ohm Size 8 Pin		
110212	Size 8 Socket		
110260	Precision 50 ohm Size 8 Socket		

M39029 for MIL-C-38999 Connector

190838 / 190838-01	Size 8 Pin : w/Enviro Seal (-01)		
190839 / 190839-01	Size 8 Socket : w/Enviro Seal (-01)		
190866	Size 12 Pin		
190867	Size 12 Socket		

M39012

PIC P/N	CONNECTOR TYPE	PIC P/N	CONNECTOR TYPE
190812	BNC Straight Plug	110566	QMA Straight Plug
190813	BNC 90° Plug	110567	QMA 90° Plug
190806	C Straight Plug	190814	SMA Straight Plug
190807	C 90° Plug	190815	SMA 90° Plug
190805	HN 90° Plug	190825	SMA Inline Jack
190810	N Straight Plug	190808	TNC Straight Plug
190811	N 90° Plug	190809	TNC 90° Plug
190822	N Bulkhead Jack	190809-L	TNC 90° Plug (Long)
		190821	TNC Bulkhead Jack

*Die Sets Available On Loan Or For Purchase From PIC
Refer To Connector Drawing For Tooling
Call PIC For Availability*

CABLE CONSTRUCTION

1. Fluoropolymer Jacket (Clear)
2. Silver-Plated Copper Shield
3. Aluminum / Polyimide Shield
4. Silver-Plated Copper Flat Strip Braid
5. PTFE Dielectric
6. Silver-Plated Copper Conductor



This cable is particularly suitable for GPS, TCAS, MLS and SATCOM installations. It is lower loss, more flexible and less than half the weight of RG214 and less than one third the weight of RG393.

This special coaxial design incorporates a multi-layered shielding technique that combines conventional shields with an inner braid woven of flat strips of silver plated copper. This “unitized” shield reduces attenuation at frequencies over 1 GHz when compared to round wire braids in standard coaxial cables. Additionally, the cable VSWR is lower because the braids can be applied more uniformly. The attenuation and VSWR variation due to aging and flexure is substantially less.

It is Skydrol resistant, RoHS compliant and meets the FAA flammability requirements of FAR Part 23 and 25, Appendix F; complies with MIL-C-17 as applicable.

PHYSICAL DATA

- Conductor 15 AWG Solid SPC
- Operating Temperature -55° to +200°C
- Outer Diameter: in (mm) 0.23 (5.72)
- Minimum Bend Radius: in (mm) 1.20 (30.48)
- Weight: lbs/100 ft (kg/100 m) 5.4 (8.0)

ELECTRICAL DATA

- Impedance: ohms 50
- Capacitance: pF/ft (m) 25.0 (82.0)
- Velocity of Propagation: % 80.0
- Time Delay: ns/ft (m) 1.27 (4.17)
- RF Shielding Effectiveness: dB/min -90
- DC Resistance: ohms/1000 ft (m) 3.3 (10.7)
- Attenuation: Nom / Max dB/100 ft (dB/100 m)
 - @400 MHz 4.4 / 4.8 (14.4 / 15.7)
 - @1.0 GHz 7.0 / 7.7 (23.0 / 25.3)
 - @1.6 GHz 8.9 / 9.8 (29.2 / 32.2)
 - @5.0 GHz 16.1 / 17.7 (52.8 / 58.1)
- K Values (nom loss): K1 = 0.215, K2 = 0.000179
- Formula for Attenuation: $(K1 * \sqrt{F(MHz)}) + (K2 * F(MHz))$

All values nominal unless otherwise noted

PIC P/N **CONNECTOR TYPE**

ARINC

190519	404 Size 1
190501	600 Size 1
190502	600 Modified Size 1
190503	404/600 Size 5
190529	Size 8 Socket

M39012

PIC P/N	CONNECTOR TYPE	PIC P/N	CONNECTOR TYPE
190512	BNC Straight Plug	110580	QMA Straight Plug
190513	BNC 90° Plug	110581	QMA 90° Plug
190506	C Straight Plug	190514	SMA Straight Plug
190507	C 90° Plug	190515	SMA 90° Plug
190504	HN Straight Plug	111082	SMA Bulkhead Jack
190505	HN 90° Plug	190508	TNC Straight Plug
190510	N Straight Plug	190509	TNC 90° Plug
190511	N 90° Plug	190531	TNC 75° Plug
190524	N Inline Jack	190523	TNC Inline Jack
190522	N Bulkhead Jack	190521	TNC Bulkhead Jack

*Die Sets Available On Loan Or For Purchase From PIC
Refer To Connector Drawing For Tooling
Call PIC For Availability*

CABLE CONSTRUCTION

1. ETFE Jacket (White) Laser Markable
2. Round Silver Plated Copper
3. Silver-Plated Copper Spiral Shield
4. PTFE Dielectric
5. Stranded Silver-Plated Copper



This is a flexible, unusually lightweight cable with electrical characteristics comparable to RG393, yet weighs less than 25%. It is half the diameter (and thus far more flexible), laser-markable, easier to terminate, and easily assembled in the field.

S65161-A is 100% shielded construction, incorporating both silver-plated copper spiral (inner) and braided (outer) shields. The inner spiral shield conforms to the low-loss expanded PTFE dielectric for superior uniformity and stability of all operating parameters, initially and over time.

It is Skydrol resistant, RoHS compliant and meets the FAA flammability requirements of FAR Part 23 and 25, Appendix F; complies with MIL-C-17 as applicable.

PHYSICAL DATA

- Conductor 16 AWG Stranded SPC
- Operating Temperature -65° to +200°C
- Outer Diameter: in (mm) 0.20 (4.95)
- Minimum Bend Radius: in (mm) 1.00 (25.40)
- Weight: lbs/100 ft (kg/100 m) 3.5 (5.2)

ELECTRICAL DATA

- Impedance: ohms 50
- Capacitance: pF/ft (m) 26.0 (85.3)
- Velocity of Propagation: % 83.0
- Time Delay: ns/ft (m) 1.23 (4.04)
- RF Shielding Effectiveness: dB/min -110
- DC Resistance: ohms/1000 ft (m) 3.9 (12.8)
- Attenuation: Nom / Max dB/100 ft (dB/100 m)
 - @400 MHz 5.1 / 5.6 (16.7 / 18.4)
 - @1.0 GHz 8.2 / 9.1 (26.9 / 29.9)
 - @1.6 GHz 10.5 / 11.6 (34.4 / 38.1)
 - @5.0 GHz 19.2 / 21.1 (63.0 / 69.2)
- K Values (max loss): K1 = 8.72, K2 = 0.33
- Formula for Attenuation: $(K1 * \sqrt{F(GHz)}) + (K2 * F(GHz))$

All values nominal unless otherwise noted

PIC P/N **CONNECTOR TYPE**

ARINC

190519A	404 Size 1
190501A	600 Size 1
190502A	600 Modified Size 1
190503	404/600 Size 5

M39012

PIC P/N	CONNECTOR TYPE	PIC P/N	CONNECTOR TYPE
190512A	BNC Straight Plug	190514A	SMA Straight Plug
190513A	BNC 90° Plug	190515A	SMA 90° Plug
190506A	C Straight Plug	190508A	TNC Straight Plug
190507A	C 90° Plug	190509A	TNC 90° Plug
190504A	HN Straight Plug	190531A	TNC 75° Plug
190505A	HN 90° Plug	190523A	TNC Inline Jack
190510A	N Straight Plug	190521A	TNC Bulkhead Jack
190511A	N 90° Plug		
190524A	N Inline Jack		
190522A	N Bulkhead Jack		

*Die Sets Available On Loan Or For Purchase From PIC
Refer To Connector Drawing For Tooling
Call PIC For Availability*

CABLE CONSTRUCTION

1. Fluoropolymer Jacket (Clear)
2. Silver-Plated Copper Shield
3. Aluminum / Polyimide Shield
4. Silver-Plated Copper Flat Strip Braid
5. PTFE Dielectric
6. SPCCS Center Conductor



This cable is particularly suitable for GPS, TCAS, MLS, Mode S and SATCOM installations. It is dimensionally identical to RG142, but has lower loss and improved shielding.

This special coaxial design incorporates a multi-layered shielding technique that combines conventional shields with an inner braid woven of flat strips of silver plated copper. This “unitized” shield reduces attenuation at frequencies over 1 GHz when compared to round wire braids in standard coaxial cables. Additionally, the cable VSWR is lower because the braids can be applied more uniformly. The attenuation and VSWR variation due to aging and flexure is substantially less.

S44193 can be terminated with standard RG142/RG400 connectors.

It is Skydrol resistant, RoHS compliant and meets the FAA flammability requirements of FAR Part 23 and 25, Appendix F; complies with MIL-C-17 as applicable.

PHYSICAL DATA

- Conductor 19 AWG Solid SPCCS
- Operating Temperature -55° to +200°C
- Outer Diameter: in (mm) 0.195 (4.95)
- Minimum Bend Radius: in (mm) 1.00 (25.40)
- Weight: lbs/100 ft (kg/100 m) 4.3 (6.4)

ELECTRICAL DATA

- Impedance: ohms 50
- Capacitance: pF/ft (m) 29.3 (96.1)
- Velocity of Propagation: % 69.5
- Time Delay: ns/ft (m) 1.46 (4.79)
- RF Shielding Effectiveness: dB/min -90
- DC Resistance: ohms/1000 ft (m) 19.1 (62.7)
- Attenuation: Nom / Max dB/100 ft (dB/100 m)
 - @400 MHz 6.8 / 7.5 (22.3 / 24.6)
 - @1.0 GHz 11.1 / 12.2 (36.4 / 40.0)
 - @1.6 GHz 14.3 / 15.7 (46.9 / 51.5)
 - @5.0 GHz 26.8 / 29.5 (87.9 / 96.8)
- K Values (nom loss): K1 = 0.3265, K2 = 0.00075
- Formula for Attenuation: $(K1 * \sqrt{F(MHz)}) + (K2 * F(MHz))$

All values nominal unless otherwise noted

PIC P/N **CONNECTOR TYPE**

ARINC

190119	404 Size 1
190101	600 Size 1
190102	600 Modified Size 1
110123	404/600 Size 5

M39012

PIC P/N	CONNECTOR TYPE	PIC P/N	CONNECTOR TYPE
190112	BNC Straight Plug	110576	QMA Straight Plug
190113	BNC 90° Plug	110577	QMA 90° Plug
190127	BNC Inline Jack	110198	SMA Straight Plug
110193	BNC Bulkhead Jack	110207	SMA 90° Plug
190106	C Straight Plug	190108	TNC Straight Plug
190107	C 90° Plug	190109	TNC 90° Plug
190104	HN Straight Plug	190131	TNC 75° Plug
190105	HN 90° Plug	190123	TNC Inline Jack
190110	N Straight Plug	190121	TNC Bulkhead Jack
190111	N 90° Plug		
110087	N Bulkhead Jack		

Also fit PIC S44191, RG142 and RG400

*Die Sets Available On Loan Or For Purchase From PIC
Refer To Connector Drawing For Tooling
Call PIC For Availability*

CABLE CONSTRUCTION

1. Fluoropolymer Jacket (Clear)
2. Silver-Plated Copper Shield
3. Silver-Plated Copper Flat Strip Braid
4. PTFE Dielectric
5. Silver-Plated Copper Conductor



Designed as a lightweight replacement for M17/60-RG142, S88207 is two-thirds the diameter and less than half the weight — 19 lbs vs 43 lbs per 1,000 ft. for RG142. This is accomplished through the use of a low-loss PTFE expanded-tape dielectric between the center conductor and the shield. In addition, the inner braid is a silver-plated copper strip braid, offering improved shielding and greater strength than conventional wire braid.

Attenuation figures are approximately 20% better than RG142. A fluoropolymer jacket protects the cable against abrasion and environmental effects while maintaining flexibility for ease of installation.

It is Skydrol resistant, RoHS compliant and meets the FAA flammability requirements of FAR Part 23 and 25, Appendix F; complies with MIL-C-17 as applicable.

PHYSICAL DATA

• Conductor	20 AWG Solid SPC
• Operating Temperature	-55° to +200°C
• Outer Diameter: in (mm)	0.13 (3.30)
• Minimum Bend Radius: in (mm)	0.65 (16.51)
• Weight: lbs/100 ft (kg/100 m)	1.9 (2.8)

ELECTRICAL DATA

• Impedance: ohms	50
• Capacitance: pF/ft (m)	25.0 (82.0)
• Velocity of Propagation: %	80.0
• Time Delay: ns/ft (m)	1.27 (4.17)
• RF Shielding Effectiveness: dB/min	-80
• DC Resistance: ohms/1000 ft (m)	10.3 (33.8)
• Attenuation: Nom / Max	dB/100 ft (dB/100 m)
• @400 MHz	8.0 / 8.8 (26.2 / 28.9)
• @1.0 GHz	12.8 / 14.1 (42.0 / 46.3)
• @1.6 GHz	16.4 / 18.0 (53.8 / 59.1)
• @5.0 GHz	30.0 / 33.0 (98.4 / 108.3)
• K Values (nom loss):	K1 = 0.39, K2 = 0.00049
• Formula for Attenuation:	$(K1 * \sqrt{F(MHz)}) + (K2 * F(MHz))$

All values nominal unless otherwise noted

PIC P/N	CONNECTOR TYPE	PIC P/N	CONNECTOR TYPE
ARINC			
190819	404 Size 1	190803	404/600 Size 5
190801	600 Size 1	190837	Size 8 Pin
190802	600 Modified Size 1	190829	Size 8 Socket

D-SUB			
110286	Size 8 Pin		
111113	Precision 50 ohm Size 8 Pin		
110212	Size 8 Socket		
110260	Precision 50 ohm Size 8 Socket		

M39029 for MIL-C-38999 Connector

190838 / 190838-01	Size 8 Pin : w/Enviro Seal (-01)		
190839 / 190839-01	Size 8 Socket : w/Enviro Seal (-01)		
190866	Size 12 Pin		
190867	Size 12 Socket		

M39012

PIC P/N	CONNECTOR TYPE	PIC P/N	CONNECTOR TYPE
190812	BNC Straight Plug	110566	QMA Straight Plug
190813	BNC 90° Plug	110567	QMA 90° Plug
190806	C Straight Plug	190814	SMA Straight Plug
190807	C 90° Plug	190815	SMA 90° Plug
190805	HN 90° Plug	190808	TNC Straight Plug
190810	N Straight Plug	190809	TNC 90° Plug
190811	N 90° Plug	190809-L	TNC 90° Plug (Long)
190822	N Bulkhead Jack	190821	TNC Bulkhead Jack

*Die Sets Available On Loan Or For Purchase From PIC
Refer To Connector Drawing For Tooling
Call PIC For Availability*

CABLE CONSTRUCTION

1. Fluoropolymer Jacket (Blue)
2. Silver-Plated Copper Braided Shield
3. Silver-Plated Copper Spiral Shield
4. PTFE Dielectric
5. Silver-Plated Copper Clad Steel Conductor

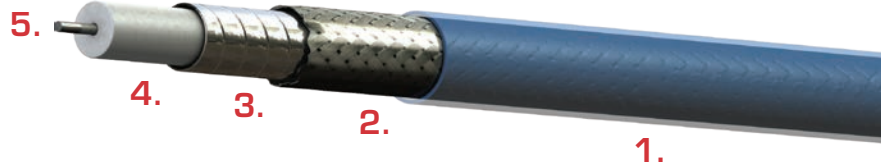

This cable is a flexible equivalent of RG405 semi-rigid coax. It employs dual shielding, the inner spiral shield providing a close-conforming shield similar to that of a semi-rigid tubing.

Compared to RG405, S40501 has comparable attenuation figures and a considerably higher temperature rating. Impedance is precisely controlled for low VSWR's.

A fluoropolymer jacket insulates and protects the cable against abrasion and environmental effects while maintaining flexibility for ease of installation.

It is Skydrol resistant, RoHS compliant and meets the FAA flammability requirements of FAR Part 23 and 25, Appendix F; complies with MIL-C-17 as applicable.

PHYSICAL DATA

- Conductor 24 AWG Solid SPCCS
- Operating Temperature -55° to +200°C
- Outer Diameter: in (mm) 0.10 (2.54)
- Minimum Bend Radius: in (mm) 0.63 (16.00)
- Weight: lbs/100 ft (kg/100 m) 1.4 (2.1)

ELECTRICAL DATA

- Impedance: ohms 50
- Capacitance: pF/ft (m) 29.4 (96.5)
- Velocity of Propagation: % 70.0
- Time Delay: ns/ft (m) 1.45 (4.76)
- RF Shielding Effectiveness: dB/min -110
- DC Resistance: ohms/1000 ft (m) 24.2 (79.4)
- Attenuation: Nom / Max dB/100 ft (dB/100 m)
 - @400 MHz 12.1 / 13.3 (39.7 / 43.6)
 - @1.0 GHz 19.4 / 21.4 (63.6 / 70.2)
 - @1.6 GHz 24.8 / 27.4 (81.4 / 89.9)
 - @5.0 GHz 45.7 / 50.3 (149.9 / 165.0)
- K Values (nom loss): K1 = 0.589, K2 = 0.00081
- Formula for Attenuation: $(K1 * \sqrt{F(MHz)}) + (K2 * F(MHz))$

All values nominal unless otherwise noted

CABLE CONSTRUCTION

1. ETFE Jacket (White) Laser Markable
2. Silver-Plated Copper Braided Shield
3. Foil Inner Shield
4. PTFE Dielectric
5. Stranded Silver-Plated Copper Covered Steel



PIC P/N S31601 Coaxial cable is a 50 Ohm cable equivalent in size as the standard MIL Spec cable RG316 but slightly lower in loss due to the extra inner foil shield. The inner foil shield also achieves -90 dB shielding effectiveness compared to only -50 dB for RG316.

This cable was designed mainly to replace RG316. The cable is manufactured with a white ETFE laser-markable jacket which saves the user considerable time, eliminating the need to label the cable at certain intervals.

The cable dimensions have remained basically the same as RG316, allowing the use of standard COTS (Commercial-Off-The-Shelf) connectors.

This cable is Skydrol resistant, RoHS compliant and meets the FAA Flammability requirement of FAR PART 23 and 25.

PHYSICAL DATA

• Conductor	26 AWG Stranded SPCCS
• Operating Temperature	-55° to +200°C
• Outer Diameter: in (mm)	0.10 (2.54)
• Minimum Bend Radius: in (mm)	0.50 (12.70)
• Weight: lbs/100 ft (kg/100 m)	1.0 (1.5)

ELECTRICAL DATA

• Impedance: ohms	50
• Capacitance: pF/ft (m)	32.0 (105.0)
• Velocity of Propagation: %	69.5
• Time Delay: ns/ft (m)	1.45 (4.76)
• RF Shielding Effectiveness: dB/min	-90
• DC Resistance: ohms/1000 ft (m)	84.1 (275.9)
• Attenuation: Nom / Max	dB/100 ft (dB/100 m)
• @400 MHz	16.0 / 19.0 (52.5 / 62.3)
• @1.0 GHz	26.3 / 31.2 (86.3 / 102.4)
• @1.6 GHz	34.2 / 40.5 (112.2 / 132.9)
• @3.0 GHz	48.9 / 58.0 (160.4 / 190.3)
• K Values (nom loss):	K1 = 0.75, K2 = 0.0026
• Formula for Attenuation:	$(K1 * \sqrt{F(MHz)}) + (K2 * F(MHz))$

All values nominal unless otherwise noted

PIC P/N **CONNECTOR TYPE**

M39012

PIC P/N **CONNECTOR TYPE**

111069	BNC
111128	BNC Straight Plug
111130	BNC 90° Plug
111132	BNC Bulkhead Jack
111134	BNC Inline Jack
111154	MMCX Straight Plug
111136	N 90° Plug
111146	QMA Straight Plug
111138	SMA Straight Plug
111140	SMA 90° Plug
111142	SMA Bulkhead Jack
111144	SMA Inline Jack
111148	SMB Straight Plug
111150	SMB 90° Plug

*Die Sets Available On Loan Or For Purchase From PIC
Refer To Connector Drawing For Tooling
Call PIC For Availability*

CABLE CONSTRUCTION

1. Fluoropolymer Jacket (Tan)
2. Tin-Plated Copper Braid Shield
3. Aluminum Braid Shield
4. Fluoropolymer Dielectric
5. Tin-Plated Copper Conductor



Certain avionics systems — TCAS, TCAD®, IHAS, for example — specify a range of antenna cable insertion loss rather than a maximum loss. The loss minimum may be difficult to achieve in shorter cable lengths without coiling extra length of cable or inserting attenuators. Either situation adds weight and cost. This cable addresses these problems.

S46191 is a 50 ohm coaxial cable, dimensionally equivalent to M17/128-RG400, but whose loss is greater by approximately 8 dB per 100 feet at 1.0 GHz. RG400 is typically 15 dB; S46191 is approximately 23 dB. In addition, S46191 will provide at least 40% weight savings over RG400.

A fluoropolymer jacket protects the cable against abrasion and environmental effects while maintaining flexibility for ease of installation.

It is Skydrol resistant, RoHS compliant and meets the FAA flammability requirements of FAR Part 23 and 25, Appendix F; complies with MIL-C-17 as applicable.

Application Data

	TCAS II/MODE-S	TCAD®	IHAS
Loss Range:	2.0 - 3.0 dB @ 1.03 GHz	2.5 - 3.5 dB @ 1.0 GHz	1.0 - 3.0 dB @ 1.09 GHz
Length Range:			
S46191	9.5 - 12 ft.	12.5 - 14 ft.	5 - 11 ft.
RG400	13.5 - 18.5 ft.	16.5 - 22 ft.	6.5 - 18.5 ft.

PHYSICAL DATA

- Conductor 20 AWG Stranded TPC
- Operating Temperature -55° to +150°C
- Outer Diameter: in (mm) 0.20 (4.95)
- Minimum Bend Radius: in (mm) 1.00 (25.40)
- Weight: lbs/100 ft (kg/100 m) 2.7 (4.0)

ELECTRICAL DATA

- Impedance: ohms 50
- Capacitance: pF/ft (m) 28.4 (93.2)
- Velocity of Propagation: % 70.0
- Time Delay: ns/ft (m) 1.45 (4.76)
- RF Shielding Effectiveness: dB/min -75
- DC Resistance: ohms/1000 ft (m) 9.5 (31.2)
- Attenuation: Nom / Max dB/100 ft (dB/100 m)
 - @400 MHz 12.8 / 14.0 (42.0 / 45.9)
 - @1.0 GHz 22.3 / 24.6 (73.2 / 80.7)
 - @1.6 GHz 30.2 / 33.3 (99.1 / 109.3)
 - @5.0 GHz 66.3 / 72.9 (217.5 / 239.2)
- K Values (nom loss): K1 = 0.52, K2 = 0.0059
- Formula for Attenuation: $(K1 * \sqrt{F(MHz)}) + (K2 * F(MHz))$

All values nominal unless otherwise noted

PIC P/N **CONNECTOR TYPE**

ARINC

190119	404 Size 1
190101	600 Size 1
190102	600 Modified Size 1
110123	404/600 Size 5

M39012

PIC P/N	CONNECTOR TYPE	PIC P/N	CONNECTOR TYPE
190112	BNC Straight Plug	110576	QMA Straight Plug
190113	BNC 90° Plug	110577	QMA 90° Plug
190127	BNC Inline Jack	110198	SMA Straight Plug
110193	BNC Bulkhead Jack	110207	SMA 90° Plug
190106	C Straight Plug	190108	TNC Straight Plug
190107	C 90° Plug	190109	TNC 90° Plug
190104	HN Straight Plug	190131	TNC 75° Plug
190105	HN 90° Plug	190123	TNC Inline Jack
190110	N Straight Plug	190121	TNC Bulkhead Jack
190111	N 90° Plug		
110087	N Bulkhead Jack		

*Die Sets Available On Loan Or For Purchase From PIC
Refer To Connector Drawing For Tooling
Call PIC For Availability*

CABLE CONSTRUCTION

1. ETFE Jacket (White) Laser Markable
2. Tin-Plated Copper Shields
3. ETFE Inner Jacket (White)
4. Foil Shield
5. Foamed Fluoropolymer
6. Silver-Plated Copper Conductor

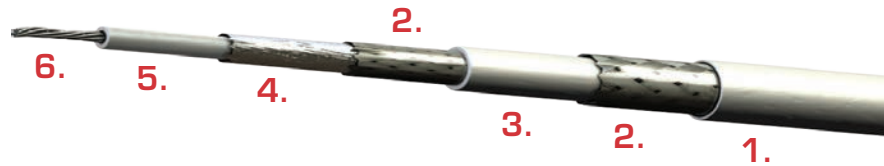

Lightweight • Small • Flexible • Exceptional EMI Immunity

L8620TX provides unusual efficiency and flexibility in this coaxial-design cable with the added EMI protection by means of an isolated second 95%-coverage shield.

In triaxial cables, the outer shield is customarily grounded in order to provide a bypass for both induced and electric field noise currents. Thus EMI is significantly reduced. PIC connectors for PIC cables S86208 and S88207 can be used to terminate the “inner coax” of L8620TX.

Triax can also be connected in “driven shield” mode, using the center conductor and inner shield connected together at the signal end, with the outer shield as a coaxial return path. At the receiving end, the inner braid is unconnected, floating, to function as a Faraday shield between the active conductors, greatly reducing the distributed capacitance in the cable — and this results in reduced losses and loading.

Honeywell has approved L8620TX for use as the 10base2 LAN cable in their Apex/Epic system.

L8620TX is Skydrol resistant, RoHS compliant and meets the FAA flammability requirements of FAR Part 23 and 25, Appendix F; complies with MIL-C-17 as applicable.

CONNECTOR DATA

110397 TRB Triax 3-lug Connector

PHYSICAL DATA

- Conductor 21 AWG Stranded SPC
- Operating Temperature -55° to +150°C
- Outer Diameter: in (mm) 0.17 (4.39)
- Minimum Bend Radius: in (mm) 0.85 (21.59)
- Weight: lbs/100 ft (kg/100 m) 2.9 (4.3)

ELECTRICAL DATA

- Impedance: ohms 50
- Capacitance: pF/ft (m) 28.0 (91.9)
- Velocity of Propagation: % 79.0
- Time Delay: ns/ft (m) 1.28 (4.20)
- RF Shielding Effectiveness: dB/min -90
- DC Resistance: ohms/1000 ft (m) 11.6 (38.1)
- Attenuation: Nom / Max dB/100 ft (dB/100 m)
 - @400 MHz 9.1 / 10.0 (29.9 / 32.8)
 - @1.0 GHz 15.1 / 16.6 (49.5 / 54.5)
 - @1.6 GHz 19.7 / 21.7 (64.6 / 71.2)
 - @5.0 GHz 38.9 / 42.8 (127.6 / 140.4)
- K Values (nom loss): K1 = 0.416, K2 = 0.0019
- Formula for Attenuation: $(K1 * \sqrt{F(MHz)}) + (K2 * F(MHz))$

All values nominal unless otherwise noted

CABLE CONSTRUCTION

1. Fluoropolymer Jacket (Clear)
2. Tinned Copper Braid Shields
3. Fluoropolymer Inner Jacket (Clear)
4. Fluoropolymer Dielectric
5. Tinned Copper Conductor

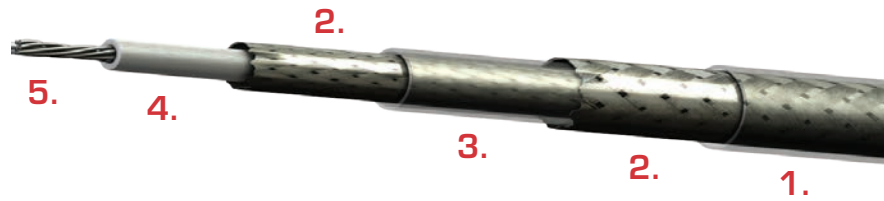

L2201TX is a 50-ohm coaxial cable with an additional outer copper braid shield insulated from the signal carrying conductors. Grounding the other shield reduces noise pick-up, improving the signal-to-noise ratio. For maximum shielding efficiency triaxial connectors should be used where the isolation of the two shields is maintained through the connectors.

This cable is recommended for radar or other systems that are susceptible to RFI and noise generating devices. Honeywell has approved this cable for the Epic/Apex system.

PIC connectors for PIC cables S44191 and S44193 can be used to terminate the “inner coax” of L2201TX.

It is Skydrol resistant, RoHS compliant and meets the FAA flammability requirements of FAR Part 23 and 25, Appendix F; complies with MIL-C-17.

CONNECTOR DATA

110438 TRB Triax 3-lug Connector

PHYSICAL DATA

• Conductor	20 AWG Stranded SPC
• Operating Temperature	-55° to +150°C
• Outer Diameter: in (mm)	0.25 (6.22)
• Minimum Bend Radius: in (mm)	1.25 (31.75)
• Weight: lbs/100 ft (kg/100 m)	6.0 (8.9)

ELECTRICAL DATA

• Impedance: ohms	50	
• Capacitance: pF/ft (m)	29.0 (95.1)	
• Velocity of Propagation: %	70.0	
• Time Delay: ns/ft (m)	1.45 (4.76)	
• RF Shielding Effectiveness: dB/min	-75	
• DC Resistance: ohms/1000 ft (m)	9.7 (31.8)	
• Attenuation: Nom / Max	dB/100 ft	(dB/100 m)
• @400 MHz	10.6 / 11.7	34.8 / 38.4
• @1.0 GHz	20.4 / 22.4	66.9 / 73.5
• @1.6 GHz	29.1 / 32.0	95.5 / 105.0
• @5.0 GHz	72.7 / 80.0	238.5 / 266.5
• K Values (nom loss):	K1 = 0.335, K2 = 0.0098	
• Formula for Attenuation:	$(K1 * \sqrt{F(MHz)}) + (K2 * F(MHz))$	

All values nominal unless otherwise noted



PIC Wire & Cable's® 75 ohm coaxial and triaxial video cables are lightweight, low loss, flexible and easy to terminate. They are specifically designed and manufactured for reliable performance in aircraft systems and other harsh environments involving high temperature, strong EMI and/or corrosive materials. All PIC 75 ohm video cables are Skydrol resistant, RoHS compliant, meet the FAA flammability requirements of FAR Part 23 and 25 Appendix F, and they comply with MIL-C-17 as applicable.

For over 45 years, PIC Wire & Cable has been a global provider of electronic cables, cable connectors and cable assemblies installed in airplanes, helicopters, rail transport and marine vehicles. PIC interconnect products are widely specified for use in major aerospace and military systems throughout the world, and our VideoMATES® line is focused on these applications:

- Cockpit Displays
- SMPTE 259M Video
- Surveillance Cameras
- SMPTE 292M Video
- Cabin Entertainment
- SMPTE 424M Video



75 OHM VIDEO CABLE SOLUTIONS

Physical and Electrical Data

All values nominal unless otherwise noted

Coaxial Cable	Conductor	Loss dB/100 ft (dB/100 m)	Cable O.D. in (mm)	Weight lbs/100 ft (kg/100 m)	Temperature Range (°C)	Shielding Effectiveness (dB)	Application	RG Replacement
V75268	26 AWG Stranded	5.9 (19.4) @ 135 MHz	0.12 (3.10)	1.3 (1.9)	-55/+150	-50	SMPTE 259M	RG: 179 & 187
V76261	26 AWG Stranded	5.8 (19.0) @ 135 MHz	0.12 (3.10)	1.1 (1.7)	-55/+150	-90	SMPTE 259M	RG: 179 & 187
V73263	26 AWG Stranded	20.6 (67.6) @ 1.50 GHz	0.13 (3.18)	1.5 (2.2)	-55/+150	-110	SMPTE 292, 424M, 2081-1 & 2082-1	N/A
V78209	20 AWG Stranded	19.0 (62.3) @ 3.00 GHz	0.21 (5.36)	3.2 (4.7)	-55/+150	-90	SMPTE 292, 424M, 2081-1 & 2082-1	RG: 6, 59, & 302
Triaxial Cable								
L7626TX	26 AWG Stranded	5.5 (18.0) @ 100 MHz	0.16 (3.99)	2.2 (3.3)	-55/+150	-90	Radar Systems	N/A

CABLE CONSTRUCTION

1. Fluoropolymer Jacket (Red)
2. Tin-Plated Copper
3. Foamed Fluoropolymer Dielectric
4. Silver-Plated Copper



This coaxial cable has been designed for 75 ohm applications such as cabin entertainment analog and digital video. Compared with M17/94-RG179, this cable is substantially stronger (more than twice the tensile strength) and has better attenuation characteristics.

At the heart of V75268 is a silver-plated copper center conductor nearly 60% larger than in RG179 — yet the overall diameter of the cable increases by only 22%. To achieve the correct impedance in this proportionately-smaller diameter, a foamed fluoropolymer dielectric having a high velocity of propagation is employed to surround the center conductor. The cable is 95% (minimum) shielded with a braid of tin-plated copper. A distinctive red fluoropolymer jacket protects the cable against abrasion and environmental effects while maintaining flexibility for ease of installation.

It is Skydrol resistant, RoHS compliant and meets the FAA flammability requirements of FAR Part 23 and 25, Appendix F; complies with MIL-C-17 as applicable.

Because of the critical effect of impedance-matched terminations, a comprehensive family of 75 ohm connectors is available.

RECOMMENDED MAX TRANSMISSION LENGTHS:

- SMPTE 259M (SD-SDI Component): 461'
- SMPTE 259M (SD-SDI Widescreen): 394'

(Max length based on 30 dB max. Contact system OEM to verify max loss allowed)

PHYSICAL DATA

• Conductor	26 AWG Stranded SPC
• Tensile Strength: lbs (kg) Approx.	8.1 (3.6)
• Operating Temperature	-55° to +150°C
• Outer Diameter: in (mm)	0.12 (3.10)
• Minimum Bend Radius: in (mm)	0.60 (15.24)
• Weight: lbs/100 ft (kg/100 m)	1.3 (1.9)

ELECTRICAL DATA

• Impedance: ohms	75	
• Capacitance: pF/ft (m)	16.0 (52.5)	
• Velocity of Propagation: %	80.0	
• Time Delay: ns/ft (m)	1.27 (4.17)	
• RF Shielding Effectiveness: dB/min	-50	
• DC Resistance: ohms/1000 ft (m)	34.5 (113.2)	
• Attenuation: Nom / Max	dB/100 ft	(dB/100 m)
• @135 MHz	5.9 / 6.5	(19.4 / 21.3)
• @180 MHz	6.9 / 7.6	(22.6 / 24.9)
• @270 MHz	8.6 / 9.5	(28.2 / 31.2)
• @360 MHz	10.1 / 11.1	(33.1 / 36.4)
• K Values (nom loss):	K1 = 0.478, K2 = 0.0029	
• Formula for Attenuation:	$(K1 * \sqrt{F(MHz)}) + (K2 * F(MHz))$	

All values nominal unless otherwise noted

ARINC

PIC P/N	CONNECTOR TYPE	PIC P/N	CONNECTOR TYPE
190703	Size 5 Socket 50 ohm	190730	Size 16 Socket
190733	Size 5 Socket 75 ohm	110237	Mil-C-81659 Size 9 Socket
190729	Size 8 Socket 50 ohm		
190732	Size 8 Socket 75 ohm		

D-SUB

PIC P/N	CONNECTOR TYPE	PIC P/N	CONNECTOR TYPE
110235	Size 8 Pin 50 ohm	110236	Size 8 Socket 50 ohm
190763	Size 8 Pin 75 ohm	190764	Size 8 Socket 75 ohm

DIN

PIC P/N	CONNECTOR TYPE
110842	1.0/2.3 Plug

M39029 for MIL-C-38999 Connector

PIC P/N	CONNECTOR TYPE	PIC P/N	CONNECTOR TYPE
190738	Size 8 Pin 50 ohm	190739	Size 8 Socket 50 ohm
190738-01	Size 8 Pin 50 ohm w/seal	190741	Size 8 Socket 75 ohm
190740	Size 8 Pin 75 ohm	190741-01	Size 8 Socket 75 ohm w/seal
190740-01	Size 8 Pin 75 ohm w/seal	190767	Size 12 Socket
190766	Size 12 Pin	190734	Size 16 Socket
190735	Size 16 Pin		

M39012

PIC P/N	CONNECTOR TYPE	PIC P/N	CONNECTOR TYPE
190712	BNC Straight Plug	190736	SMB 75 ohm Socket
110717	BNC HD Straight Plug	110285	SMC 75 ohm Female Plug
110249	BNC 90° Plug	190768	SMC 75 ohm 90° Female Plug
190745	BNC Mini Straight Plug	110863	SMZ 75 ohm Straight Female Plug
111069	BNC Mini 90° Plug		SMZ 75 ohm 90° Female Plug
190727	BNC Inline Jack	110865	SMA Straight Plug
190728	BNC Bulkhead Jack	190714	
110783	BNC HD Straight Bulkhead Jack	190708	TNC Straight Plug
		190721	TNC Bulkhead Jack
110677	F Straight Plug		
110218	RCA Straight Plug		

*Die Sets Available On Loan Or For Purchase From PIC
Refer To Connector Drawing For Tooling
Call PIC For Availability*

CABLE CONSTRUCTION

1. ETFE Jacket (White) Laser Markable
2. Tin-Plated Copper
3. Aluminized Wrapper
4. Foamed Fluoropolymer Dielectric
5. Stranded Silver-Plated Copper

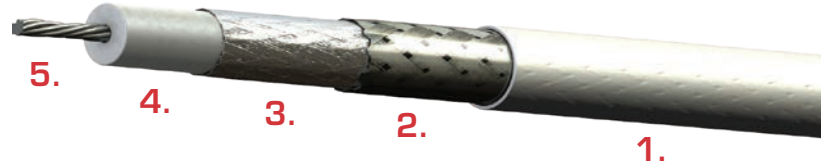

This coaxial cable has been designed for 75 ohm applications such as cabin entertainment analog and digital video. Compared with M17/94-RG179, this cable is substantially stronger (more than twice the tensile strength), has better attenuation characteristics, and has superior shielding effectiveness. At the same time, it is approximately the same weight. V76261 has been approved by Honeywell for the Apex/Epic system.

The V76261 construction includes a stranded silver-plated copper center conductor nearly 60% larger than in RG179 — yet the overall diameter of the cable increases by only 23%. To maintain correct impedance in its small diameter, a foamed fluoropolymer dielectric surrounds the center conductor. The cable is double-shielded with a braid of tin-plated copper and an aluminized 100%-coverage wrapper. This combination yields better than -90 dB shielding effectiveness. Tefzel jacketing protects the cable against abrasion and environmental effects while maintaining flexibility for ease of installation. It is laser-markable.

It is Skydrol resistant, RoHS compliant and meets the FAA flammability requirements of FAR Part 23 and 25, Appendix F; complies with MIL-C-17.

Because of the critical effect of impedance-matched terminations, a comprehensive family of 75 ohm connectors is available.

RECOMMENDED MAX TRANSMISSION LENGTHS:

- SMPTE 259M (SD-SDI Component): 468'
- SMPTE 259M (SD-SDI Widescreen): 405'

(Max length based on 30 dB max. Contact system OEM to verify max loss allowed)

PHYSICAL DATA

- Conductor 26 AWG Stranded SPC
- Tensile Strength: lbs (kg) Approx. 8.1 (3.6)
- Operating Temperature -55° to +150°C
- Outer Diameter: in (mm) 0.12 (3.10)
- Minimum Bend Radius: in (mm) 0.64 (16.13)
- Weight: lbs/100 ft (kg/100 m) 1.1 (1.7)

ELECTRICAL DATA

- Impedance: ohms 75
- Capacitance: pF/ft (m) 16.0 (52.5)
- Velocity of Propagation: % 80.0
- Time Delay: ns/ft (m) 1.27 (4.17)
- RF Shielding Effectiveness: dB/min -90
- DC Resistance: ohms/1000 ft (m) 34.5 (113.2)
- Attenuation: Nom / Max dB/100 ft (dB/100 m)
 - @135 MHz 5.8 / 6.4 (19.0 / 21.0)
 - @180 MHz 6.7 / 7.4 (22.0 / 24.3)
 - @270 MHz 8.3 / 9.1 (27.2 / 29.9)
 - @360 MHz 9.7 / 10.6 (31.8 / 34.8)
- K Values (nom loss): K1 = 0.487, K2 = 0.0012
- Formula for Attenuation: $(K1 * \sqrt{F(MHz)} + (K2 * F(MHz)))$

All values nominal unless otherwise noted

ARINC

PIC P/N	CONNECTOR TYPE	PIC P/N	CONNECTOR TYPE
190703	Size 5 Socket 50 ohm	190730	Size 16 Socket
190733	Size 5 Socket 75 ohm	110237	Mil-C-81659 Size 9 Socket
190729	Size 8 Socket 50 ohm		
190732	Size 8 Socket 75 ohm		

D-SUB

PIC P/N	CONNECTOR TYPE	PIC P/N	CONNECTOR TYPE
110235	Size 8 Pin 50 ohm	110236	Size 8 Socket 50 ohm
190763	Size 8 Pin 75 ohm	190764	Size 8 Socket 75 ohm

DIN

PIC P/N	CONNECTOR TYPE
110842	1.0/2.3 Plug

M39029 for MIL-C-38999 Connector

PIC P/N	CONNECTOR TYPE	PIC P/N	CONNECTOR TYPE
190738	Size 8 Pin 50 ohm	190739	Size 8 Socket 50 ohm
190738-01	Size 8 Pin 50 ohm w/seal	190741	Size 8 Socket 75 ohm
190740	Size 8 Pin 75 ohm	190741-01	Size 8 Socket 75 ohm w/seal
190740-01	Size 8 Pin 75 ohm w/seal	190767	Size 12 Socket
190766	Size 12 Pin	190734	Size 16 Socket
190735	Size 16 Pin		

M39012

PIC P/N	CONNECTOR TYPE	PIC P/N	CONNECTOR TYPE
190712	BNC Straight Plug	190736	SMB 75 ohm Socket
110717	BNC HD Straight Plug	110285	SMC 75 ohm Female Plug
110249	BNC 90° Plug	190768	SMC 75 ohm 90° Female Plug
190745	BNC Mini Straight Plug	110863	SMZ 75 ohm Straight Female Plug
111069	BNC Mini 90° Plug		SMZ 75 ohm 90° Female Plug
190727	BNC Inline Jack	110865	SMA Straight Plug
190728	BNC Bulkhead Jack	190714	
110783	BNC HD Straight Bulkhead Jack	190708	TNC Straight Plug
		190721	TNC Bulkhead Jack
110677	F Straight Plug		
110218	RCA Straight Plug		

*Die Sets Available On Loan Or For Purchase From PIC
Refer To Connector Drawing For Tooling
Call PIC For Availability*

CABLE CONSTRUCTION

1. ETFE Jacket (White) Laser Markable
2. Tin-Plated Copper Braid
3. Silver-Plated Copper Helical Strip
4. Foamed Fluoropolymer Dielectric
5. Silver-Plated Copper

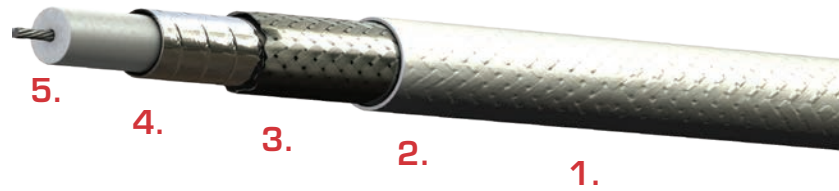

This coaxial cable is designed for 75 ohm applications, such as high-definition digital video, and offers low VSWR and attenuation characteristics. Refer to the statement below for the maximum recommended transmission lengths for this cable.

The construction of V73263 includes a silver-plated copper center conductor, a foamed fluoropolymer dielectric and is double-shielded with a helically-wound silver-plated copper strip and a tin-plated copper braid. This combination yields better than -110 dB shielding effectiveness. ETFE jacketing protects the cable against abrasion and environmental effects while maintaining flexibility for ease of installation. It is laser-markable.

It is Skydrol resistant, RoHS compliant and meets the FAA flammability requirements of FAR Part 23 and 25, Appendix F; complies with MIL-C-17 as applicable.

Because of the critical effect of impedance-matched terminations, a comprehensive family of 75 ohm connectors is available.

RECOMMENDED MAX TRANSMISSION LENGTHS:

- SMPTE ST 292 (HD-SDI): 125' @750 MHz
- SMPTE ST 424 (3G-SDI): 85' @1.50 GHz
- SMPTE ST 2081-1 (6G-SDI): 120' @3.00 GHz
- SMPTE ST 2082-1 (12G-SDI): 80' @6.00 GHz

(Max length based on 20 dB max. Contact system OEM to verify max loss allowed)

(Max length based on 40 dB max. Contact system OEM to verify max loss allowed)

PHYSICAL DATA

- Conductor 26 AWG Stranded SPC
- Tensile Strength: lbs (kg) Approx. 8.1 (3.6)
- Operating Temperature -55° to +150°C
- Outer Diameter: in (mm) 0.13 (3.18)
- Minimum Bend Radius: in (mm) 0.65 (16.51)
- Weight: lbs/100 ft (kg/100 m) 1.5 (2.2)

ELECTRICAL DATA

- Impedance: ohms 75
- Capacitance: pF/ft (m) 16.0 (52.5)
- Velocity of Propagation: % 80.0
- Time Delay: ns/ft (m) 1.27 (4.17)
- RF Shielding Effectiveness: dB/min -110
- DC Resistance: ohms/1000 ft (m) 34.5 (113.2)
- Attenuation: Nom / Max dB/100 ft (dB/100 m)
 - @400 MHz 10.2 / 11.3 (33.5 / 37.1)
 - @750 MHz 14.2 / 15.7 (46.6 / 51.5)
 - @1.50 GHz 20.6 / 22.7 (67.6 / 74.5)
 - @3.00 GHz 30.3 / 33.3 (99.4 / 109.3)
 - @6.00 GHz 44.9 / 49.5 (147.3 / 162.4)

- K Values (nom loss): K1 = 0.487, K2 = 0.0012
- Formula for Attenuation: $(K1 * \sqrt{F(MHz)}) + (K2 * F(MHz))$

All values nominal unless otherwise noted

ARINC

PIC P/N	CONNECTOR TYPE	PIC P/N	CONNECTOR TYPE
190703	Size 5 Socket 50 ohm	190730	Size 16 Socket
190733	Size 5 Socket 75 ohm	110237	Mil-C-81659 Size 9 Socket
190729	Size 8 Socket 50 ohm		
190732	Size 8 Socket 75 ohm		

D-SUB

PIC P/N	CONNECTOR TYPE	PIC P/N	CONNECTOR TYPE
110235	Size 8 Pin 50 ohm	110236	Size 8 Socket 50 ohm
190763	Size 8 Pin 75 ohm	190764	Size 8 Socket 75 ohm

DIN

PIC P/N	CONNECTOR TYPE
110842	1.0/2.3 Plug

M39029 for MIL-C-38999 Connector

PIC P/N	CONNECTOR TYPE	PIC P/N	CONNECTOR TYPE
190738	Size 8 Pin 50 ohm	190739	Size 8 Socket 50 ohm
190738-01	Size 8 Pin 50 ohm w/seal	190741	Size 8 Socket 75 ohm
190740	Size 8 Pin 75 ohm	190741-01	Size 8 Socket 75 ohm w/seal
190740-01	Size 8 Pin 75 ohm w/seal	190767	Size 12 Socket
190766	Size 12 Pin	190734	Size 16 Socket
190735	Size 16 Pin		

M39012

PIC P/N	CONNECTOR TYPE	PIC P/N	CONNECTOR TYPE
190712	BNC Straight Plug	190736	SMB 75 ohm Socket
110717	BNC HD Straight Plug	110285	SMC 75 ohm Female Plug
110249	BNC 90° Plug	190768	SMC 75 ohm 90° Female Plug
190745	BNC Mini Straight Plug	110863	SMZ 75 ohm Straight Female Plug
111069	BNC Mini 90° Plug		SMZ 75 ohm 90° Female Plug
190727	BNC Inline Jack	110865	SMA Straight Plug
190728	BNC Bulkhead Jack	190714	
110783	BNC HD Straight Bulkhead Jack	190708	TNC Straight Plug
		190721	TNC Bulkhead Jack
110677	F Straight Plug		
110218	RCA Straight Plug		

*Die Sets Available On Loan Or For Purchase From PIC
Refer To Connector Drawing For Tooling
Call PIC For Availability*

CABLE CONSTRUCTION

1. ETFE Jacket (White) Laser Markable
2. Tin-Plated Copper
3. Aluminized Wrapper
4. Foamed Fluoropolymer Dielectric
5. Stranded Silver-Plated Copper



This coaxial cable is designed for 75 ohm applications, such as high-definition digital video, and offers low VSWR and attenuation characteristics. Refer to the statement below for the maximum recommended transmission lengths for this cable.

The construction of V78209 includes a silver-plated copper center conductor, a foamed fluoropolymer dielectric and it is double-shielded with a braid of tin-plated copper and an aluminized 100%-coverage wrapper. Tefzel jacketing protects the cable against abrasion and environmental effects while maintaining flexibility for ease of installation. It is laser-markable.

V78209 is Skydrol resistant, RoHS compliant and meets the FAA flammability requirements of FAR Part 23 and 25, Appendix F. V78209 complies with MIL-DTL-17 as applicable.

Because of the critical effect of impedance-matched terminations, a comprehensive family of 75 ohm connectors is available. Please contact PIC Wire & Cable for more details.

RECOMMENDED MAX TRANSMISSION LENGTHS:

- SMPTE ST 292 (HD-SDI): 210' @750 MHz
- SMPTE ST 424 (3G-SDI): 140' @1.50 GHz

(Max length based on 20 dB max. Contact system OEM to verify max loss allowed)

- SMPTE ST 2081-1 (6G-SDI): 191' @3.00 GHz
- SMPTE ST 2082-1 (12G-SDI): 125' @6.00 GHz

(Max length based on 40 dB max. Contact system OEM to verify max loss allowed)

PHYSICAL DATA

• Conductor	20 AWG Stranded SPC
• Operating Temperature	-55° to +150°C
• Outer Diameter: in (mm)	0.21 (5.36)
• Minimum Bend Radius: in (mm)	1.10 (27.94)
• Weight: lbs/100 ft (kg/100 m)	3.2 (4.7)

ELECTRICAL DATA

• Impedance: ohms	75
• Capacitance: pF/ft (m)	16.5 (54.1)
• Velocity of Propagation: %	80.0
• Time Delay: ns/ft (m)	1.27 (4.17)
• RF Shielding Effectiveness: dB/min	-90
• DC Resistance: ohms/1000 ft (m)	8.7 (28.4)
• Attenuation: Nom / Max	dB/100 ft (dB/100 m)
• @400 MHz	6.1 / 6.7 (20.0 / 22.0)
• @750 MHz	8.6 / 9.5 (28.2 / 31.2)
• @1.50 GHz	12.7 / 14.0 (41.7 / 45.9)
• @3.00 GHz	19.0 / 20.9 (62.3 / 68.6)
• @6.00 GHz	29.0 / 32.0 (95.1 / 105.0)

• K Values (nom loss): K1 = 0.282, K2 = 0.0012

• Formula for Attenuation: $(K1 * \sqrt{F(MHz)} + (K2 * F(MHz)))$

All values nominal unless otherwise noted

PIC P/N **CONNECTOR TYPE**

ARINC

190937	Size 8 Pin 75 ohm
190932	Size 8 Socket 75 ohm

DIN

PIC P/N **CONNECTOR TYPE**

110844	1.0/2.3 Plug
---------------	---------------------

M39029 for MIL-C-38999 Connector

PIC P/N **CONNECTOR TYPE**

190940	Size 8 Pin 75 ohm
190940-01	Size 8 Pin 75 ohm with seal
190941	Size 8 Socket 75 ohm
190941-01	Size 8 Socket 75 ohm with seal

M39012

PIC P/N	CONNECTOR TYPE	PIC P/N	CONNECTOR TYPE
190912	BNC Straight Plug	190944	SMC 75 ohm Female Plug
110718	BNC HD Straight Plug	190908	TNC Straight Plug
190913	BNC 90° Plug	190909	TNC 90° Plug
190945	BNC Mini Straight Plug	190921	TNC Bulkhead Jack
190946	BNC Mini 90° Plug		
190928	BNC Bulkhead Jack		

*Die Sets Available On Loan Or For Purchase From PIC
Refer To Connector Drawing For Tooling
Call PIC For Availability*

CABLE CONSTRUCTION

1. ETFE Jacket (White) Laser Markable
2. Tin-Plated Copper Shields
3. ETFE Inner Jacket (White)
4. Foil Shield
5. Foamed Fluoropolymer Dielectric
6. Stranded Silver-Plated Copper Conductor

L7626TX provides a significant advantage in weight and flexibility in this 75 ohm cable with added EMI protection by means of an isolated second 95% coverage shield — the major benefit of a triaxial design.

Used for video signals in cabin entertainment and other airborne applications, the outer shield is customarily grounded in order to provide a bypass for both induced and electric field noise currents. Thus EMI is significantly reduced.

L7626TX is Skydrol resistant, RoHS compliant and meets the FAA flammability requirements of FAR Part 23 and 25, Appendix F; complies with MIL-C-17 as applicable.

All connectors which are used for PIC cables V75268 and V76261 can be used for terminating the “inner coax” of L7626TX.

CONNECTOR DATA

110459 TRB Triax 3-lug Connector

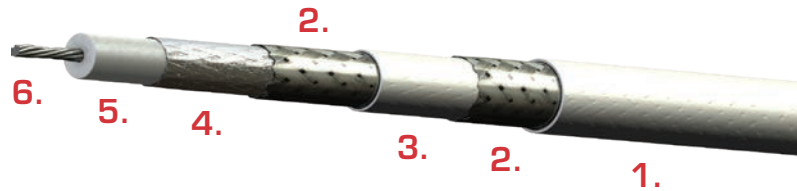

PHYSICAL DATA

• Conductor	26 AWG Stranded SPC
• Tensile Strength: lbs (kg) Approx.	25.0 (11.3)
• Operating Temperature	-55° to +150°C
• Outer Diameter: in (mm)	0.16 (3.99)
• Minimum Bend Radius: in (mm)	0.80 (20.32)
• Weight: lbs/100 ft (kg/100 m)	2.2 (3.3)

ELECTRICAL DATA

• Impedance: ohms	75	
• Capacitance: pF/ft (m)	16.0 (52.5)	
• Velocity of Propagation: %	80.0	
• Time Delay: ns/ft (m)	1.27 (4.17)	
• RF Shielding Effectiveness: dB/min	-90	
• DC Resistance: ohms/1000 ft (m)	38.5 (126.3)	
• Attenuation: Nom / Max	dB/100 ft	(dB/100 m)
• @100 MHz	5.5 / 6.1	(18.0 / 20.0)
• @400 MHz	11.2 / 12.3	(36.7 / 40.4)
• @1.45 GHz	21.6 / 23.8	(70.9 / 78.1)
• @3.00 GHz	31.6 / 34.8	(103.7 / 114.2)
• K Values (nom loss):	K1 = 0.55, K2 = 0.0005	
• Formula for Attenuation:	$(K1 * \sqrt{F(MHz)}) + (K2 * F(MHz))$	

All values nominal unless otherwise noted



At PIC Wire & Cable®, our mission is to make our customers' job easier by providing high quality, high performance engineered electronic cables and interconnect solutions for demanding military and aerospace applications. For over 45 years, PIC Wire & Cable has helped industry leading companies improve their platform performance, reduce their schedules & lower their total costs through a unique combination of quality, technology and service.

Using the latest technologies, PIC cable products are designed and manufactured to meet the stringent electrical and mechanical performance criteria required for these advanced electronic applications - EMI immunity, lightweight, low loss, high temperature, harsh environment. Ensuring world class quality and reliability is a top priority at PIC, as evidenced by our world class quality certifications and consistently positive customer feedback.

PIC Wire & Cable is once again advancing high speed data communication technology with our extensive DataMATES® Ethernet line that offers tailored solutions for many civil and military aerospace applications, including:

- Ethernet Communications Backbone
- Mobile Shelters
- Cabin Management
- In-flight Entertainment
- Avionics Networks
- High Definition Video

ETHERNET SOLUTIONS

Physical and Electrical Data 1 Pair Cables

All values nominal unless otherwise noted

Part Number	Speed Rating	Data Conductor	Weight lbs/100 ft (kg/100 m)	O.D. in (mm)	Jacket	Temperature Range (°C)	Max Distance ft (m)
E5E2222-D	10/100 BASE-T	22 AWG SPC	2.3 (3.4)	0.18 (4.57)	White Fluoropolymer Laser Markable	-55/+200	*
E10222	10/100 BASE-T	22 AWG TPC	2.3 (3.4)	0.19 (4.80)	White Fluoropolymer Laser Markable	-50/+150	362 (110)
E13224	10/100 BASE-T	24 AWG SPCA	2.2 (3.3)	0.16 (4.06)	White Fluoropolymer Tape Laser Markable	-55/+200	328 (100)
E5E2224-D	10/100 BASE-T	24 AWG SPCA	2.0 (3.0)	0.16 (4.06)	White Fluoropolymer Laser Markable	-55/+200	*
E61224	10/100 BASE-T	24 AWG SPCA	1.9 (2.8)	0.15 (3.81)	White Fluoropolymer Laser Markable	-50/+200	328 (100)
E10224	10/100 BASE-T	24 AWG SPC	2.2 (3.2)	0.16 (4.06)	Blue Fluoropolymer	-50/+200	328 (100)
E20224	10/100 BASE-T	24 AWG SPCA	1.1 (1.6)	0.14 (3.58)	White Fluoropolymer Laser Markable	-50/+200	273 (83)
E12224	10/100 BASE-T	24 AWG TPC	1.6 (2.4)	0.15 (3.71)	White Fluoropolymer Laser Markable	-55/+150	255 (78)
E60224	10/100 BASE-T	24 AWG SPC	0.9 (1.3)	0.10 (2.59)	White Fluoropolymer Laser Markable	-55/+200	*
E13226	10/100 BASE-T	26 AWG SPCA	1.7 (2.5)	0.13 (3.40)	White Fluoropolymer Laser Markable	-55/+200	224 (68)

Materials Key: TPC – Tin-Plated Copper; SPC – Silver-Plated Copper; SPCA – Silver-Plated Copper Alloy

*no maximum distance

2 Pair Cables

Part Number	Speed Rating	Data Conductor	Weight lbs/100 ft (kg/100 m)	O.D. in (mm)	Jacket	Temperature Range (°C)	Max Distance ft (m)
E10422	10/100 BASE-T	22 AWG SPC	3.7 (5.5)	0.30 (7.94)	White Fluoropolymer Laser Markable	-55/+200	328 (100)
E13424	10/100 BASE-T	24 AWG SPCA	2.9 (4.3)	0.22 (5.59)	White Fluoropolymer Tape Laser Markable	-55/+200	262.5 (80)
E61424	10/100 BASE-T	24 AWG SPCA	2.9 (4.3)	0.22 (5.59)	White Fluoropolymer Laser Markable	-55/+200	269 (80)
E10424	10/100 BASE-T	24 AWG SPC	3.3 (4.9)	0.21 (5.28)	Blue Fluoropolymer	-55/+200	268 (82)
E12424	10/100 BASE-T	24 AWG TPC	2.3 (3.4)	0.21 (5.28)	White Fluoropolymer Laser Markable	-55/+150	257 (78)
E20424	10/100 BASE-T	24 AWG SPC	4.2 (6.2)	0.27 (6.73)	Blue Fluoropolymer	-55/+200	296 (90)
E13426	10/100 BASE-T	26 AWG SPCA	2.0 (2.9)	0.16 (3.99)	White Fluoropolymer Laser Markable	-55/+200	224 (68)

4 Pair Cables

Part Number	Speed Rating	Data Conductor	Weight lbs/100 ft (kg/100 m)	O.D. in (mm)	Jacket	Temperature Range (°C)	Max Distance ft (m)
E74824	10G BASE-T	24 AWG SPCA	4.7 (7.0)	0.28 (7.11)	White Fluoropolymer Laser Markable	-55/+200	296 (90)
E6A6824	10G BASE-T	24 AWG SPCA	4.4 (6.5)	0.26 (6.60)	White Fluoropolymer Tape Laser Markable	-55/+200	246 (75)
E6A5824	10G BASE-T	24 AWG SPCA	4.2 (6.3)	0.26 (6.60)	White Fluoropolymer Tape Laser Markable	-55/+200	296 (90)
E6A0824	10G BASE-T	24 AWG SPC	5.3 (7.9)	0.28 (6.99)	Blue Fluoropolymer	-55/+200	246 (75)
E6A2824	10G BASE-T	24 AWG TPC	4.6 (6.8)	0.28 (6.99)	White Fluoropolymer Laser Markable	-55/+150	214 (65)
E50824	1000 BASE-T	24 AWG SPC	5.0 (7.4)	0.27 (6.73)	Blue Fluoropolymer	-55/+200	268 (82)
DV0824	1000 BASE-T	24 AWG SPCA	7.7 (11.5)	0.35 (8.89)	White Fluoropolymer Laser Markable	-55/+200	*
E74826	10G BASE-T	26 AWG SPCA	3.3 (4.9)	0.23 (5.84)	White Fluoropolymer Laser Markable	-55/+200	230 (70)
E6A6826	10G BASE-T	26 AWG SPCA	3.2 (4.8)	0.22 (5.59)	White Fluoropolymer Tape Laser Markable	-55/+200	214 (65)
E6A5826	10G BASE-T	26 AWG SPCA	3.0 (4.5)	0.21 (5.33)	White Fluoropolymer Tape Laser Markable	-55/+200	230 (70)

Quadaxial Cables

Part Number	Speed Rating	Data Conductor	Weight lbs/100 ft (kg/100 m)	O.D. in (mm)	Jacket	Temperature Range (°C)	Max Distance ft (m)
E51424	10/100 BASE-T	24 AWG SPCA	2.2 (3.3)	0.16 (4.06)	White Fluoropolymer Laser Markable	-55/+150	255 (78)
E50424	10/100 BASE-T	24 AWG SPC	2.7 (4.0)	0.17 (4.32)	Blue Fluoropolymer	-55/+200	236 (72)
E51426	10/100 BASE-T	26 AWG SPCA	1.8 (2.7)	0.14 (3.48)	White Fluoropolymer Tape Laser Markable	-55/+150	214 (65)
E51428	10/100 BASE-T	28 AWG SPCA	1.0 (1.5)	0.11 (2.92)	White Fluoropolymer Tape Laser Markable	-55/+200	170 (51)

CABLE CONSTRUCTION

1. ETFE Jacket (White) Laser Markable
2. Silver-Plated Copper Braided Shield
3. Foil Shield
4. Silver-Plated Copper Drain Wire
5. Foamed Fluoropolymer Insulation
6. Silver-Plated Copper Conductors

COLOR CODES

Pair #1 - White, Blue

This cable incorporates innovative design features that provide maximum electrical performance in a small, lightweight, flexible package.

This cable is manufactured with a white ETFE jacket that is laser-markable and also very rugged, passing the abrasion testing of EN3475-503. The data pairs are manufactured using a high temp Fluoropolymer. The data pairs will perform exceptionally for low skew video applications. Data transmission aboard aircraft faces more severe environmental and EMI situations than conventional LAN systems in commercial buildings, hence special measures have been taken to preserve technical performance.

E5E2222-D is ideal for harsh environment applications that demand high reliability, maximum flexibility and light weight, such as cabin management, in-flight entertainment, internet backbones. It is Skydrol resistant, RoHS compliant and passes the FAA flammability requirements of FAR Part 23 and 25, Appendix F.



PHYSICAL DATA

- Conductors 22 AWG (19/34) Stranded SPC
- Shield Coverage: 90% (Braid)
- Operating Temperature: -55° to +200°C
- Outer Diameter: in (mm) 0.18 (4.57)
- Minimum Bend Radius: in (mm) 0.90 (22.86)
- Weight: lbs/100 ft (kg/100 m) 2.3 (3.4)

ELECTRICAL DATA

Data pair

- Impedance: ohms 100
- Capacitance: pF/ft (m) 13.0 (42.7)
- Velocity of Propagation: % 80.0
- Dielectric Voltage Rating (kV, RMS) Max 0.9
- DC Resistance: ohms/1000 ft (m) Max 17.5 (57.4)
- Intra-Pair Skew pS/ft (m) Max 7.0 (22.9)
- Attenuation: Nom / Max dB/100 ft (dB/100 m)
 - @10 MHz 1.5 / 1.8 (4.9 / 5.9)
 - @100 MHz 5.4 / 6.5 (17.7 / 21.3)

All values nominal unless otherwise noted

CABLE CONSTRUCTION

1. ETFE Jacket (White) Laser Markable
2. Tin-Plated Copper Braided Shield
3. Foil Shield
4. Foamed Fluoropolymer Insulation
5. Tin-Plated Copper Conductors



COLOR CODES

Blue, White

This cable has been specially designed by PIC for airborne 10 and 100 Base-T Local Area Network applications as defined by ARINC Specification 664. The twisted-pair construction effectively reduces inductive interference while 100% foil and 90% braided shielding serve to further protect against EMI.

Data transmission aboard aircraft faces more severe environmental and EMI situations than conventional LAN systems in commercial buildings, hence special measures have been taken to preserve technical performance.

Each conductor is surrounded by a foamed fluoropolymer dielectric having a high velocity of propagation which permits smaller overall diameter and weight while retaining performance and required operating parameters. Tin-plated copper conductors and shielding assure uniform conductivity with excellent solderability. An ETFE jacket protects the cable against abrasion and environmental effects while maintaining flexibility for ease of installation.

E10222 exceeds ANSI/TIA-568-C.2 CAT 5e Channel Requirements. It is Skydrol resistant, RoHS compliant and passes the FAA flammability requirements of FAR Part 23 and 25, Appendix F. Test results are available upon request.

PHYSICAL DATA

• Conductors	22 AWG Stranded TPC
• Shield Coverage	100% (Foil), 90% (Braid)
• Operating Temperature	-50° to +150°C
• Outer Diameter: in (mm)	0.19 (4.80)
• Minimum Bend Radius: in (mm)	0.95 (24.13)
• Weight: lbs/100 ft (kg/100 m)	2.3 (3.4)

ELECTRICAL DATA

• Impedance: ohms	100	
• Capacitance: pF/ft (m)	13.0 (42.7)	
• Velocity of Propagation: %	80.0	
• Dielectric Voltage Rating (kV RMS)	0.9	
• DC Resistance: ohms/1000 ft (m) Max	15.8 (51.8)	
• Max Distance*: ft (m)	362 (110)	
• Attenuation: Nom / Max	dB/100 ft	(dB/100 m)
• @10 MHz	1.5 / 1.8	(4.9 / 5.9)
• @100 MHz	5.4 / 6.5	(17.7 / 21.3)

All values nominal unless otherwise noted
 *Note: The max distance is based on maximum channel insertion loss per ANSI/TIA-568-C.2

CABLE CONSTRUCTION

1. PTFE Tape Jacket (White) Laser Markable
2. Silver-Plated Copper Braided Shield
3. Fluoropolymer Tape Binder
4. Fluoropolymer Fillers
5. Solid Fluoropolymer Conductor Insulation
6. Silver-Plated High Strength Copper Alloy Conductors

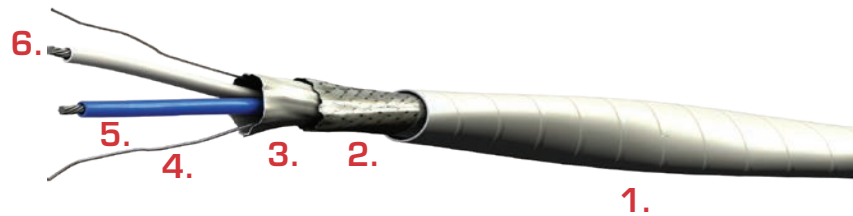

COLOR CODES

Blue, White

PIC's DataMATES Ethernet cables incorporate innovative design features that provide maximum electrical performance in a small, light weight and flexible package. Using 24 AWG silver-plated, high strength copper alloy conductors and a laser markable PTFE tape jacket, PIC's E13224 delivers CAT 5e channel performance up to 328 ft (100 m) with up to 45% less weight and up to 50% more flexibility.

Data transmission aboard aircraft faces more severe environmental and EMI situations than conventional LAN systems in commercial buildings, hence special measures have been taken to preserve technical performance. Silver-plated copper conductors and shielding assure uniform conductivity with excellent solderability.

A PTFE jacket which is laser-markable, passed EN3475-503 Scrape Abrasion testing and is also very flexible for ease of installation.

E13224 is ideal for harsh environment applications that demand high reliability, maximum flexibility and light weight, such as cabin management, in-flight entertainment, internet backbones. It is Skydrol resistant, RoHS compliant and passes the FAA flammability requirements of FAR Part 23 and 25, Appendix F.

PHYSICAL DATA

- Conductors 24 AWG (19/36) Stranded SPCA
- Shield Coverage 80% (Braid)
- Operating Temperature -55° to +200°C
- Outer Diameter: in (mm) 0.16 (4.06)
- Minimum Bend Radius: in (mm) 1.25 (31.75)
- Weight: lbs/100 ft (kg/100 m) 2.2 (3.3)

ELECTRICAL DATA

- Impedance: ohms 100
- Capacitance: pF/ft (m) 14.5 (47.6)
- Velocity of Propagation: % 70.0
- Dielectric Voltage Rating (kV RMS) 1.5
- DC Resistance: ohms/1000 ft (m) Max 28.4 (93.2)
- Max Distance: ft (m) 328 (100)
- Attenuation: Nom / Max dB/100 ft (dB/100 m)
 - @10 MHz 1.8 / 2.1 (5.9 / 6.9)
 - @100 MHz 5.8 / 7.0 (19.0 / 23.0)

*All values nominal unless otherwise noted
 Note: The max distance is based on maximum channel insertion loss per ISO 11801, Class F*

CABLE CONSTRUCTION

1. ETFE Jacket (White) Laser Markable
2. Silver-Plated Copper Braided Shield
3. Foil Shield
4. Silver-Plated Copper Drain Wire
5. Foamed Fluoropolymer Insulation
6. Silver-Plated High Strength Copper Alloy Conductors

COLOR CODES

Pair #1 - White, Blue

This cable incorporates innovative design features that provide maximum electrical performance in a small, lightweight, flexible package.

This cable is manufactured with a white ETFE jacket that is laser-markable and also very rugged, passing the abrasion testing of EN3475-503. The data pairs are manufactured using a high temp Fluoropolymer. The data pairs will perform exceptionally for low skew video applications. Data transmission aboard aircraft faces more severe environmental and EMI situations than conventional LAN systems in commercial buildings, hence special measures have been taken to preserve technical performance.

E5E2224-D is ideal for harsh environment applications that demand high reliability, maximum flexibility and light weight, such as cabin management, in-flight entertainment, internet backbones. It is Skydrol resistant, RoHS compliant and passes the FAA flammability requirements of FAR Part 23 and 25, Appendix F.



PHYSICAL DATA

- Conductors 24 AWG (19/36) Stranded SPCA
- Shield Coverage: 90% (Braid)
- Operating Temperature: -55° to +200°C
- Outer Diameter: in (mm) 0.16 (4.06)
- Minimum Bend Radius: in (mm) 0.80 (20.32)
- Weight: lbs/100 ft (kg/100 m) 2.0 (3.0)

ELECTRICAL DATA

Data pair

- Impedance: ohms 100
- Capacitance: pF/ft (m) 13.0 (42.7)
- Velocity of Propagation: % 80.0
- Dielectric Voltage Rating (kV, RMS) Max 0.9
- DC Resistance: ohms/1000 ft (m) Max 28.4 (93.2)
- Intra-Pair Skew pS/ft (m) Max 7.0 (22.9)
- Attenuation: Nom / Max dB/100 ft (dB/100 m)
 - @10 MHz 2.0 / 2.3 (6.6 / 7.5)
 - @100 MHz 6.0 / 7.7 (19.7 / 25.3)

All values nominal unless otherwise noted

CABLE CONSTRUCTION

1. ETFE Jacket (White) Laser Markable
2. Silver-Plated Copper Braided Shield
3. Foil Shield
4. Foamed Fluoropolymer Insulation
5. Silver-Plated High Strength Copper Alloy Conductors



COLOR CODES

Blue, White

This cable has been specially designed by PIC for airborne 10 and 100 Base-T Local Area Network applications as defined by ARINC Specification 664. The twisted-pair construction effectively reduces inductive interference while 100% foil and 90% braided shielding serve to further protect against EMI.

Each conductor is surrounded by a foamed fluoropolymer dielectric having a high velocity of propagation which permits smaller overall diameter and weight while retaining performance and required operating parameters. Silver plated high strength copper alloy conductors and shielding assure uniform conductivity with excellent solderability. A laser markable fluoropolymer jacket protects the cable against abrasion and environmental effects while maintaining flexibility for ease of installation.

Data transmission aboard aircraft faces more severe environmental and EMI situations than conventional LAN systems in commercial buildings, hence special measures have been taken to preserve technical performance.

E61224 exceeds ANSI/TIA-568-C.2 CAT 5e Channel Requirements. It is Skydrol resistant, RoHS compliant and passes the FAA flammability requirements of FAR Part 23 and 25, Appendix F. Test results are available upon request.

PHYSICAL DATA

- | | |
|---------------------------------|--------------------------|
| • Conductors | 24 AWG Stranded SPCA |
| • Shield Coverage | 100% (Foil), 90% (Braid) |
| • Operating Temperature | -50° to +200°C |
| • Outer Diameter: in (mm) | 0.15 (3.81) |
| • Minimum Bend Radius: in (mm) | 1.25 (31.75) |
| • Weight: lbs/100 ft (kg/100 m) | 1.9 (2.8) |

ELECTRICAL DATA

- | | |
|---------------------------------------|-------------------------|
| • Impedance: ohms | 100 |
| • Capacitance: pF/ft (m) | 13.0 (42.7) |
| • Velocity of Propagation: % | 80.0 |
| • Dielectric Voltage Rating (kV RMS) | 0.9 |
| • DC Resistance: ohms/1000 ft (m) Max | 28.4 (93.2) |
| • Max Distance*: ft (m) | 328 (100) |
| • Attenuation: Nom / Max | dB/100 ft (dB/100 m) |
| • @10 MHz | 1.8 / 2.1 (5.9 / 6.9) |
| • @100 MHz | 5.8 / 7.0 (19.0 / 23.0) |

All values nominal unless otherwise noted
**Note: The max distance is based on maximum channel insertion loss per ANSI/TIA-568-C.2*

CABLE CONSTRUCTION

1. Fluoropolymer Jacket (Translucent Blue)
2. Silver-Plated Copper Braided Shield
3. Foil Shield
4. Foamed Fluoropolymer Insulation
5. Silver-Plated Copper Conductors

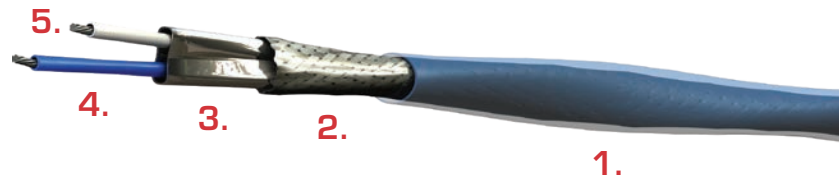

COLOR CODES

Blue, White

This cable has been specially designed by PIC for airborne 10 and 100 Base-T Local Area Network applications as defined by ARINC Specification 664. The twisted-pair construction effectively reduces inductive interference while 100% foil and 90% braided shielding serve to further protect against EMI. The cable is also approved by Honeywell for airborne NTSC/PAL/RS170 camera video where a 100-ohm balanced line is required.

Data transmission aboard aircraft faces more severe environmental and EMI situations than conventional LAN systems in commercial buildings, hence special measures have been taken to preserve technical performance.

Each conductor is surrounded by a foamed fluoropolymer dielectric having a high velocity of propagation which permits smaller overall diameter and weight while retaining performance and required operating parameters. Silver-plated copper conductors and shielding assure uniform conductivity with excellent solderability. A fluoropolymer jacket protects the cable against abrasion and environmental effects while maintaining flexibility for ease of installation.

E10224 exceeds ANSI/TIA-568-C.2 CAT 5e Channel Requirements. It is Skydrol resistant, RoHS compliant and passes the FAA flammability requirements of FAR Part 23 and 25, Appendix F. Test results are available upon request.

PHYSICAL DATA

• Conductors	24 AWG Stranded SPC
• Shield Coverage	100% (Foil), 90% (Braid)
• Operating Temperature	-50° to +200°C
• Outer Diameter: in (mm)	0.16 (4.06)
• Minimum Bend Radius: in (mm)	0.90 (22.86)
• Weight: lbs/100 ft (kg/100 m)	2.2 (3.2)

ELECTRICAL DATA

• Impedance: ohms	100
• Capacitance: pF/ft (m)	13.0 (42.7)
• Velocity of Propagation: %	80.0
• Dielectric Voltage Rating (kV RMS)	0.9
• DC Resistance: ohms/1000 ft (m) Max	28.5 (93.5)
• Max Distance*: ft (m)	328 (100)
• Attenuation: Nom / Max	dB/100 ft (dB/100 m)
• @10 MHz	1.8 / 2.1 (5.9 / 6.9)
• @100 MHz	5.8 / 7.0 (19.0 / 23.0)

All values nominal unless otherwise noted
**Note: The max distance is based on maximum channel insertion loss per ANSI/TIA-568-C.2*

CABLE CONSTRUCTION

1. ETFE Jacket (White) Laser Markable
2. Silver-Plated Copper Braided Shield
3. Foamed Fluoropolymer Insulation
4. Silver-Plated High Strength Copper Alloy Conductors



COLOR CODES

Blue, White

This cable has been specially designed by PIC for airborne 10 and 100 Base-T Local Area Network applications as defined by ARINC Specification 664.

Data transmission aboard aircraft faces more severe environmental and EMI situations than conventional LAN systems in commercial buildings, hence special measures have been taken to preserve technical performance.

Each conductor is surrounded by a foamed Fluoropolymer dielectric having a high velocity of propagation which permits smaller overall diameter and weight while retaining performance and required operating parameters. Silver-plated copper conductors and shielding assure uniform conductivity with excellent solderability. An ETFE laser markable jacket protects the cable against abrasion and environmental effects while maintaining flexibility for ease of installation.

E20224 exceeds ANSI/TIA-568-C.2 CAT 5e Channel Requirements. It is Skydrol resistant, RoHS compliant and passes the FAA flammability requirements of FAR Part 23 and 25, Appendix F. Test results are available upon request.

PHYSICAL DATA

- Conductors 24 AWG (19/36) Stranded SPCA
- Shield Coverage 80% (Braid)
- Operating Temperature -50° to +200°C
- Outer Diameter: in (mm) 0.14 (3.58)
- Minimum Bend Radius: in (mm) 0.75 (19.05)
- Weight: lbs/100 ft (kg/100 m) 1.1 (1.6)

ELECTRICAL DATA

- Impedance: ohms 100
- Capacitance: pF/ft (m) 13.0 (42.7)
- Velocity of Propagation: % 80.0
- Dielectric Voltage Rating (kV RMS) 0.9
- DC Resistance: ohms/1000 ft (m) Max 28.5 (93.5)
- Max Distance*: ft (m) 273 (83)
- Attenuation: Nom / Max dB/100 ft (dB/100 m)
 - @10 MHz 2.1 / 2.6 (6.9 / 8.5)
 - @100 MHz 7.1 / 7.5 (23.3 / 24.6)

All values nominal unless otherwise noted
 *Note: The max distance is based on maximum channel insertion loss per ANSI/TIA-568-C.2

CABLE CONSTRUCTION

1. ETFE Jacket (White) Laser Markable
2. Tin-Plated Copper Braided Shield
3. Foil Shield
4. Fluoropolymer Fillers
5. Fluoropolymer Insulation
6. Tin-Plated Copper Conductors

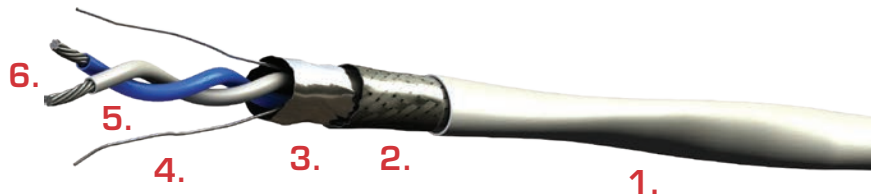

COLOR CODES

Blue, White

This cable has been specially designed by PIC for airborne 10 and 100 Base-T Local Area Network applications as defined by ARINC Specification 664. The twisted-pair construction effectively reduces inductive interference while 100% foil and 85% braided shielding serve to further protect against EMI.

Data transmission aboard aircraft faces more severe environmental and EMI situation than conventional LAN systems in commercial buildings. Hence special measures have been taken to preserve technical performance.

Each conductor is surrounded by a foamed fluoropolymer dielectric having a high velocity of propagation which permits smaller overall diameter and weight while retaining performance and required operating parameters. Tin-plated copper conductors and shielding assure uniform conductivity with excellent solderability. A fluoropolymer jacket protects the cable against abrasion and environmental effects while maintaining flexibility for ease of installation.

E12224 exceeds ANSI/TIA-568-C.2 CAT 5e Channel Requirements. It is Skydrol resistant, RoHS compliant and passes the FAA flammability requirements of FAR Part 23 and 25, Appendix F. Test results are available upon request.

PHYSICAL DATA

- | | |
|---------------------------------|--------------------------|
| • Conductors | 24 AWG Stranded TPC |
| • Shield Coverage | 100% (Foil), 85% (Braid) |
| • Operating Temperature | -55° to +150°C |
| • Outer Diameter: in (mm) | 0.15 (3.71) |
| • Minimum Bend Radius: in (mm) | 0.75 (19.05) |
| • Weight: lbs/100 ft (kg/100 m) | 1.6 (2.4) |

ELECTRICAL DATA

- | | | |
|---------------------------------------|-------------|---------------|
| • Impedance: ohms | 100 | |
| • Capacitance: pF/ft (m) | 13.0 (42.7) | |
| • Velocity of Propagation: % | 80.0 | |
| • Dielectric Voltage Rating (kV RMS) | 0.9 | |
| • DC Resistance: ohms/1000 ft (m) Max | 28.4 (93.2) | |
| • Max Distance*: ft (m) | 255 (78) | |
| • Attenuation: Nom / Max | dB/100 ft | (dB/100 m) |
| • @10 MHz | 2.3 / 2.7 | (7.5 / 8.9) |
| • @100 MHz | 8.0 / 9.2 | (26.2 / 30.2) |

All values nominal unless otherwise noted
 *Note: The max distance is based on maximum channel insertion loss per ANSI/TIA-568-C.2

CABLE CONSTRUCTION

1. ETFE Jacket (White) Laser Markable
2. Fluoropolymer Fillers
3. Fluoropolymer Insulation
4. Silver-Plated Copper Conductors

COLOR CODES

Blue, White

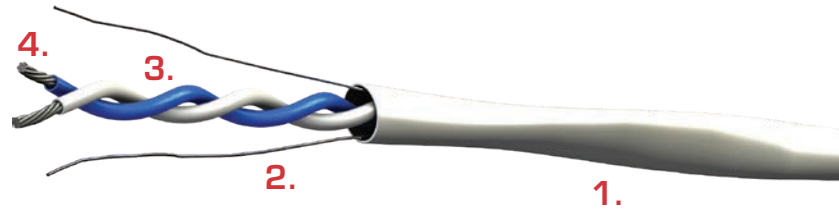

This cable has been specially designed by PIC for airborne 10 and 100 Base-T High Speed Data applications. The cable is unshielded and designed for specific entertainment systems not requiring shielding. Without the shield, termination time and weight are reduced.

Data transmission aboard aircraft faces a more severe environment than conventional LAN systems in commercial buildings, hence special measures have been taken to preserve technical performance.

Each conductor is surrounded by solid fluoropolymer. Silver-plated copper stranded conductors assure uniform conductivity with excellent solderability and flexibility. An ETFE laser wire markable jacket protects the cable against abrasion and environmental effects while maintaining flexibility for ease of installation.

E60224 exceeds ANSI/TIA-568-C.2 Channel Requirements. It is Skydrol resistant, RoHS compliant and passes the FAA flammability requirements of FAR Part 23 and 25, Appendix F. Test results are available upon request.

PHYSICAL DATA

• Conductors	24 AWG Stranded SPC
• Operating Temperature	-55° to +200°C
• Outer Diameter: in (mm)	0.10 (2.59)
• Minimum Bend Radius: in (mm)	0.60 (15.24)
• Weight: lbs/100 ft (kg/100 m)	0.9 (1.3)

ELECTRICAL DATA

• Impedance: ohms	100
• Capacitance: pF/ft (m)	14.5 (47.6)
• Velocity of Propagation: %	70.0
• Dielectric Voltage Rating (kV RMS)	1.5
• DC Resistance: ohms/1000 ft (m) Max	28.5 (93.5)
• Attenuation: Nom / Max	dB/100 ft (dB/100 m)
• @10 MHz	1.9 / 2.4 (6.2 / 7.9)
• @100 MHz	7.2 / 8.0 (23.6 / 26.2)

All values nominal unless otherwise noted

CABLE CONSTRUCTION

1. Fluoropolymer Jacket (White) Laser Markable
2. Silver-Plated Copper Braided Shield
3. Fluoropolymer Tape Binder
4. Fluoropolymer Fillers
5. Solid Fluoropolymer Insulation
6. Silver-Plated High Strength Copper Alloy Conductors

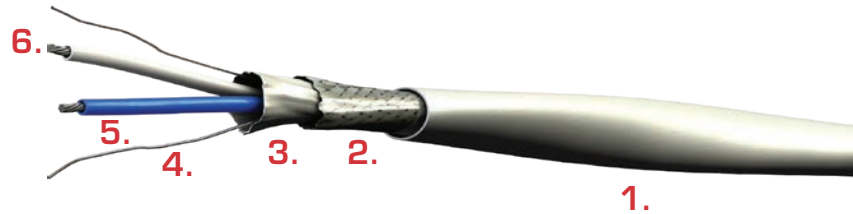

COLOR CODES

Pair #1 - White/Blue

PIC's DataMATES Ethernet cables incorporate innovative design features that provide maximum electrical performance in a small, light weight and flexible package. Using 26 AWG silver-plated, high strength copper alloy conductors and a laser markable fluoropolymer jacket, PIC's E13226 delivers CAT 5e performance up to 224 ft with up to 45% less weight and up to 50% more flexibility.

Data transmission aboard aircraft faces more severe environmental and EMI situations than conventional LAN systems in commercial buildings, hence special measures have been taken to preserve technical performance. Silver-plated copper conductors and shielding assure uniform conductivity with excellent solderability. A fluoropolymer jacket protects the cable against abrasion and environmental effects while maintaining flexibility for ease of installation.

E13226 is ideal for harsh environment applications that demand high reliability, maximum flexibility and light weight, such as cabin management, in-flight entertainment, internet backbones. It is Skydrol resistant, RoHS compliant and passes the FAA flammability requirements of FAR Part 23 and 25, Appendix F.

PHYSICAL DATA

- Conductors 26 AWG (19/38) Stranded SPCA
- Shield Coverage 80% (Braid)
- Operating Temperature -55° to +200°C
- Outer Diameter: in (mm) 0.13 (3.40)
- Minimum Bend Radius: in (mm) 0.40 (10.16)
- Weight: lbs/100 ft (kg/100 m) 1.7 (2.5)

ELECTRICAL DATA

- Impedance: ohms 100
- Capacitance: pF/ft (m) 14.5 (47.6)
- Velocity of Propagation: % 70.0
- Dielectric Voltage Rating (kV RMS) 1.5
- DC Resistance: ohms/1000 ft (m) Max 44.8 (147.0)
- Max Distance*: ft (m) 224 (68)
- Attenuation: Nom / Max dB/100 ft (dB/100 m)
 - @10 MHz 2.7 / 3.1 (8.9 / 10.2)
 - @100 MHz 8.7 / 10.5 (28.5 / 34.4)

All values nominal unless otherwise noted
 *Note: The max distance is based on maximum channel insertion loss per ANSI/TIA-568-C.2

CABLE CONSTRUCTION

1. ETFE Jacket (White) Laser Markable
2. Silver-Plated Copper Braided Shield
3. Foil Shield
4. Foamed Fluoropolymer Insulation
5. Silver-Plated Copper Conductors

COLOR CODES

Pair #1 - White/Blue

Pair #2 - Green/Orange

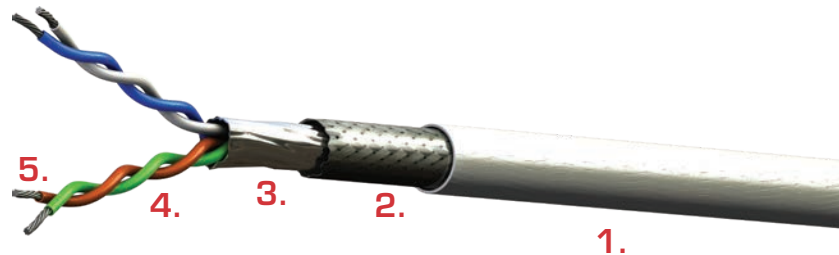

This cable has been specially designed by PIC for airborne 10 and 100 Base-T Local Area Network applications as defined by ARINC Specification 664. The twisted-pair construction (two separate pairs) effectively reduces inductive interference while 100% foil and 90% braid shielding serve to further protect against EMI.

Data transmission aboard aircraft faces more severe environmental and EMI situations than conventional LAN systems in commercial buildings, hence special measures have been taken to preserve technical performance.

Each conductor is surrounded by a foamed fluoropolymer dielectric having a high velocity of propagation which permits smaller overall diameter and weight while retaining performance and required operating parameters. Silver-plated copper conductors and shielding assure uniform conductivity with excellent solderability. An ETFE jacket protects the cable against abrasion and environmental effects while maintaining flexibility for ease of installation.

E10422 exceeds ANSI/TIA-568-C.2 CAT 5e Channel Requirements. It is Skydrol resistant, RoHS compliant and passes the FAA flammability requirements of FAR Part 23 and 25, Appendix F. Test results are available upon request.

PHYSICAL DATA

• Conductors	22 AWG Stranded SPC
• Shield Coverage	100% (Foil), 90% (Braid)
• Operating Temperature	-55° to +200°C
• Outer Diameter: in (mm)	0.30 (7.94)
• Minimum Bend Radius: in (mm)	2.80 (71.12)
• Weight: lbs/100 ft (kg/100 m)	3.7 (5.5)

ELECTRICAL DATA

• Impedance: ohms	100	
• Capacitance: pF/ft (m)	13.0 (42.7)	
• Velocity of Propagation: %	80.0	
• Dielectric Voltage Rating (kV RMS)	0.9	
• DC Resistance: ohms/1000 ft (m) Max	15.2 (49.9)	
• Max Distance*: ft (m)	328 (100)	
• Attenuation: Nom / Max	dB/100 ft	(dB/100 m)
• @10 MHz	1.4 / 1.7	(4.6 / 5.6)
• @100 MHz	4.5 / 5.4	(14.8 / 17.7)

All values nominal unless otherwise noted
**Note: The max distance is based on maximum channel insertion loss per ANSI/TIA-568-C.2*

CABLE CONSTRUCTION

1. PTFE Tape Jacket (White) Laser Markable
2. Silver-Plated Copper Braided Shield
3. Fluoropolymer Tape Binder
4. Solid Fluoropolymer Conductor Insulation
5. Silver-Plated High Strength Copper Alloy Conductors

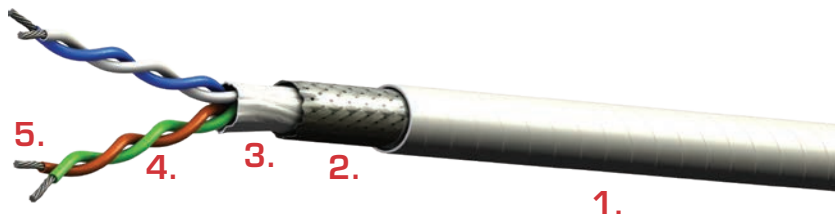

COLOR CODES

- Pair #1 - White/Blue
- Pair #2 - Green/Orange

PIC's DataMATES Ethernet cables incorporate innovative design features that provide maximum electrical performance in a small, light weight and flexible package. Using 24 AWG silver-plated, high strength copper alloy conductors and a laser markable PTFE jacket, PIC's E13424 delivers CAT 5e channel performance up to 262 ft (80 m) with up to 45% less weight and up to 50% more flexibility.

Data transmission aboard aircraft faces more severe environmental and EMI situations than conventional LAN systems in commercial buildings, hence special measures have been taken to preserve technical performance. Silver-plated copper conductors and shielding assure uniform conductivity with excellent solderability.

A PTFE jacket which is laser-markable, passed EN3475-503 Scrape Abrasion testing and is also very flexible for ease of installation.

E13424 is ideal for harsh environment applications that demand high reliability, maximum flexibility and light weight, such as cabin management, in-flight entertainment, internet backbones. It is Skydrol resistant, RoHS compliant and passes the FAA flammability requirements of FAR Part 23 and 25, Appendix F.

PHYSICAL DATA

- Conductors 24 AWG (19/38) Stranded SPCA
- Shield Coverage 80% (Braid)
- Operating Temperature -55° to +200°C
- Outer Diameter: in (mm) 0.22 (5.59)
- Minimum Bend Radius: in (mm) 0.75 (19.05)
- Weight: lbs/100 ft (kg/100 m) 2.9 (4.3)

ELECTRICAL DATA

- Impedance: ohms 100
- Capacitance: pF/ft (m) 14.5 (47.6)
- Velocity of Propagation: % 70.0
- Dielectric Voltage Rating (kV RMS) 1.5
- DC Resistance: ohms/1000 ft (m) Max 28.4 (93.2)
- Max Distance: ft (m) 262.5 (80)
- Attenuation: Nom / Max dB/100 ft (dB/100 m)
 - @10 MHz 2.2 / 2.6 (7.2 / 8.5)
 - @100 MHz 6.0 / 7.2 (19.7 / 23.6)

*All values nominal unless otherwise noted
 Note: The max distance is based on maximum channel insertion loss per ISO 11801, Class F*

Description	Connector P/N	Tool P/N
Shielded CAT 5e, Plug w/Strain Relief Sleeve	190007 (568A) 190015 (ISDN)	110340 - RJ45 Crimp Tool
Shielded CAT 5e, Plug w/Protective Boot	190061 (568A) 190062 (ISDN)	110340 - RJ45 Crimp Tool
Shielded CAT 6a, Jack w/ATUM Strain Relief	110939	110701 - Soft Jaw Clamping Pliers

As an ethernet data cable, E13424 will most often be terminated with RJ45 connectors. They are reliable, inexpensive and can trace a huge installed base virtually everywhere.

The insulation surrounding each conductor in E13424 is softer and thicker than common commercial-type ethernet cables. This is necessary to achieve data rate and maintain impedance in a shielded design. As a result, the larger diameter of this insulation will not easily enter a standard RJ45 connector cavity without modification.

PIC has designed special RJ45 type connectors designed to accommodate this larger insulation. Termination using these connectors is recommended and saves considerable time.

Note: Part 110274 has been replaced with 110340.

Call PIC For Availability

CABLE CONSTRUCTION

1. ETFE Jacket (White) Laser Markable
2. Silver-Plated Copper Braided Shield
3. Foil Shield
4. Foamed Fluoropolymer Insulation
5. Silver-Plated High Strength Copper Alloy Conductors

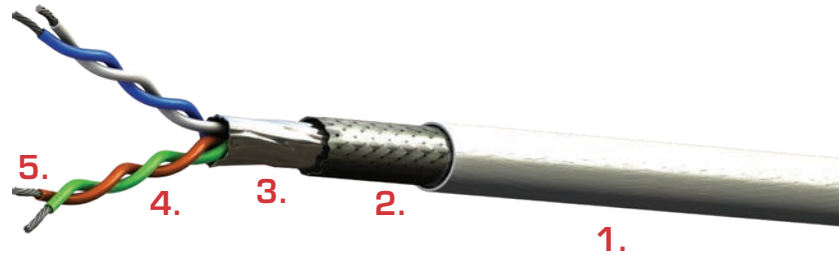

COLOR CODES

- Pair #1 - White/Blue
 Pair #2 - Green/Orange

This cable has been specially designed by PIC for airborne 10 and 100 Base-T Local Area Network applications as defined by ARINC Specification 664. The twisted-pair construction effectively reduces inductive interference while 100% foil and 90% braided shielding serve to further protect against EMI.

Each conductor is surrounded by a foamed fluoropolymer dielectric having a high velocity of propagation which permits smaller overall diameter and weight while retaining performance and required operating parameters. Silver plated high strength copper alloy conductors and shielding assure uniform conductivity with excellent solderability. A laser markable fluoropolymer jacket protects the cable against abrasion and environmental effects while maintaining flexibility for ease of installation.

Data transmission aboard aircraft faces more severe environmental and EMI situations than conventional LAN systems in commercial buildings, hence special measures have been taken to preserve technical performance.

E61224 exceeds ANSI/TIA-568-C.2 CAT 5e Channel Requirements. It is Skydrol resistant, RoHS compliant and passes the FAA flammability requirements of FAR Part 23 and 25, Appendix F. Test results are available upon request.

PHYSICAL DATA

- | | |
|---------------------------------|--------------------------|
| • Conductors | 24 AWG Stranded SPCA |
| • Shield Coverage | 100% (Foil), 90% (Braid) |
| • Operating Temperature | -55° to +200°C |
| • Outer Diameter: in (mm) | 0.22 (5.59) |
| • Minimum Bend Radius: in (mm) | 1.75 (44.45) |
| • Weight: lbs/100 ft (kg/100 m) | 2.9 (4.3) |

ELECTRICAL DATA

- | | |
|---------------------------------------|-------------------------|
| • Impedance: ohms | 100 |
| • Capacitance: pF/ft (m) | 13.5 (44.3) |
| • Velocity of Propagation: % | 80.0 |
| • Dielectric Voltage Rating (kV RMS) | 0.9 |
| • DC Resistance: ohms/1000 ft (m) Max | 28.4 (93.2) |
| • Max Distance*: ft (m) | 269 (80) |
| • Attenuation: Nom / Max | dB/100 ft (dB/100 m) |
| • @10 MHz | 2.2 / 2.6 (7.2 / 8.5) |
| • @100 MHz | 6.0 / 7.2 (19.7 / 23.6) |

All values nominal unless otherwise noted
 *Note: The max distance is based on maximum channel insertion loss per ANSI/TIA-568-C.2

Description	Connector P/N	Tool P/N
Shielded CAT 5e, Plug w/Strain Relief Sleeve	190007 (568A) 190015 (ISDN)	110340 - RJ45 Crimp Tool
Shielded CAT 5e, Plug w/Protective Boot	190061 (568A) 190062 (ISDN)	110340 - RJ45 Crimp Tool
Shielded CAT 6a, Jack w/ATUM Strain Relief	110939	110701 - Soft Jaw Clamping Pliers

As an ethernet data cable, E61424 will most often be terminated with RJ45 connectors. They are reliable, inexpensive and can trace a huge installed base virtually everywhere.

The insulation surrounding each conductor in E61424 is softer and thicker than common commercial-type ethernet cables. This is necessary to achieve data rate and maintain impedance in a shielded design. As a result, the larger diameter of this insulation will not easily enter a standard RJ45 connector cavity without modification.

PIC has designed special RJ45 type connectors designed to accommodate this larger insulation. Termination using these connectors is recommended and saves considerable time.

Note: Part 110274 has been replaced with 110340.

Call PIC For Availability

CABLE CONSTRUCTION

1. Fluoropolymer Jacket (Translucent Blue)
2. Silver-Plated Copper Braided Shield
3. Foil Shield
4. Foamed Fluoropolymer Insulation
5. Silver-Plated Copper Conductors

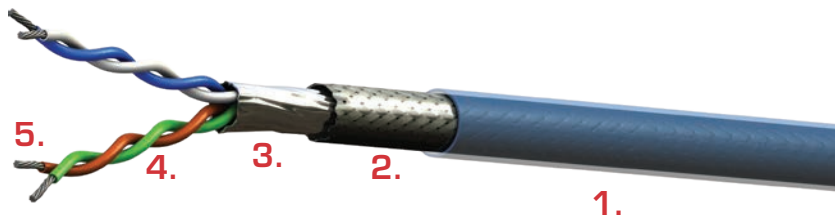

COLOR CODES

- Pair #1 - White/Blue
- Pair #2 - Green/Orange

This cable has been specially designed by PIC for airborne 10 and 100 Base-T Local Area Network applications as defined by ARINC Specification 664. The twisted-pair construction (two separate pairs) effectively reduces inductive interference while 100% foil and 90% braided shielding serve to further protect against EMI.

Data transmission aboard aircraft faces more severe environmental and EMI situations than conventional LAN systems in commercial buildings, hence special measures have been taken to preserve technical performance.

Each conductor is surrounded by a foamed fluoropolymer dielectric having a high velocity of propagation which permits smaller overall diameter and weight while retaining performance and required operating parameters. Silver-plated copper conductors and shielding assure uniform conductivity with excellent solderability. A fluoropolymer jacket protects the cable against abrasion and environmental effects while maintaining flexibility for ease of installation.

E10424 exceeds ANSI/TIA-568-C.2 CAT 5e Channel Requirements. It is Skydrol resistant, RoHS compliant and passes the FAA flammability requirements of FAR Part 23 and 25, Appendix F. Test results are available upon request.

PHYSICAL DATA

- Conductors 24 AWG Stranded SPC
- Shield Coverage 100% (Foil), 90% (Braid)
- Operating Temperature -55° to +200°C
- Outer Diameter: in (mm) 0.21 (5.28)
- Minimum Bend Radius: in (mm) 1.10 (27.94)
- Weight: lbs/100 ft (kg/100 m) 3.3 (4.9)

ELECTRICAL DATA

- Impedance: ohms 100
- Capacitance: pF/ft (m) 13.0 (42.7)
- Velocity of Propagation: % 80.0
- Dielectric Voltage Rating (kV RMS) 0.9
- DC Resistance: ohms/1000 ft (m) Max 28.5 (93.5)
- Max Distance*: ft (m) 268 (82)
- Attenuation: Nom / Max dB/100 ft (dB/100 m)
 - @10 MHz 2.2 / 2.6 (7.2 / 8.5)
 - @100 MHz 6.0 / 7.2 (19.7 / 23.6)

*All values nominal unless otherwise noted
 Note: The max distance is based on maximum channel insertion loss per ANSI/TIA-568-C.2

Description	Connector P/N	Tool P/N
Shielded CAT 5e, Plug w/Strain Relief Sleeve	190007 (568A) 190015 (ISDN)	110340 - RJ45 Crimp Tool
Shielded CAT 5e, Plug w/Strain Relief Sleeve	110362	110288 - RJ45 Crimp Tool 190048 - Insulation Compression Tool
Shielded CAT 5e, Plug w/Protective Boot	190061 (568A) 190062 (ISDN)	110340 - RJ45 Crimp Tool
Shielded CAT 6, Plug w/ATUM Strain Relief (fits Amphenol (RJF) ruggedized backshell)	110788	110288 - RJ45 Crimp Tool 190048 - Insulation Compression Tool
Shielded CAT 6a, Jack w/ATUM Strain Relief	110939	110701 - Soft Jaw Clamping Pliers

As an ethernet data cable, E10424 will most often be terminated with RJ45 connectors. They are reliable, inexpensive and can trace a huge installed base virtually everywhere.

The insulation surrounding each conductor in E10424 is softer and thicker than common commercial-type ethernet cables. This is necessary to achieve data rate and maintain impedance in a shielded design. As a result, the larger diameter of this insulation will not easily enter a standard RJ45 connector cavity without modification.

PIC has designed special RJ45 type connectors designed to accommodate this larger insulation. Termination using these connectors is recommended and saves considerable time.

Note: Part 110274 has been replaced with 110340.

Call PIC For Availability

CABLE CONSTRUCTION

1. ETFE Jacket (White) Laser Markable
2. Tin-Plated Copper Braided Shield
3. Foil Shield
4. Fluoropolymer Insulation
5. Tin-Plated Copper Conductors

COLOR CODES

Pair #1 - White/Blue

Pair #2 - Green/Orange

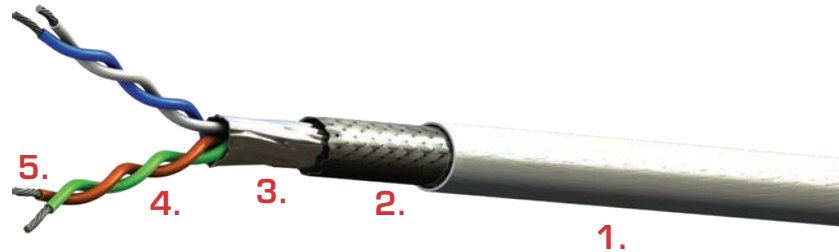

This cable has been specially designed by PIC for airborne 10 and 100 Base-T Local Area Network applications as defined by ARINC Specification 664. The twisted-pair construction (two separate pairs) effectively reduces inductive interference while 100% foil and 85% braided shielding serve to further protect against EMI.

Data transmission aboard aircraft faces more severe environmental and EMI situation than conventional LAN systems in commercial buildings. Hence special measures have been taken to preserve technical performance.

Each conductor is surrounded by a foamed fluoropolymer dielectric having a high velocity of propagation which permits smaller overall diameter and weight while retaining performance and required operating parameters. Tin-plated copper conductors and shielding assure uniform conductivity with excellent solderability. A fluoropolymer jacket protects the cable against abrasion and environmental effects while maintaining flexibility for ease of installation.

E12424 exceeds ANSI/TIA-568-C.2 CAT 5e Channel Requirements. It is Skydrol resistant, RoHS compliant and passes the FAA flammability requirements of FAR Part 23 and 25, Appendix F. Test results are available upon request.

PHYSICAL DATA

- | | |
|---------------------------------|--------------------------|
| • Conductors | 24 AWG Stranded TPC |
| • Shield Coverage | 100% (Foil), 85% (Braid) |
| • Operating Temperature | -55° to +150°C |
| • Outer Diameter: in (mm) | 0.21 (5.28) |
| • Minimum Bend Radius: in (mm) | 1.00 (25.4) |
| • Weight: lbs/100 ft (kg/100 m) | 2.3 (3.4) |

ELECTRICAL DATA

- | | |
|---------------------------------------|-------------------------|
| • Impedance: ohms | 100 |
| • Capacitance: pF/ft (m) | 13.0 (42.7) |
| • Velocity of Propagation: % | 80.0 |
| • Dielectric Voltage Rating (kV RMS) | 0.9 |
| • DC Resistance: ohms/1000 ft (m) Max | 28.5 (93.5) |
| • Max Distance*: ft (m) | 257 (78) |
| • Attenuation: Nom / Max | dB/100 ft (dB/100 m) |
| • @10 MHz | 2.3 / 2.7 (7.5 / 8.9) |
| • @100 MHz | 6.2 / 7.5 (20.3 / 24.6) |

All values nominal unless otherwise noted
**Note: The max distance is based on maximum channel insertion loss per ANSI/TIA-568-C.2*

Description	Connector P/N	Tool P/N
Shielded CAT 5e, Plug w/Strain Relief Sleeve	190007 (568A) 190015 (ISDN)	110340 - RJ45 Crimp Tool
Shielded CAT 5e, Plug w/Strain Relief Sleeve	110362	110288 - RJ45 Crimp Tool 190048 - Insulation Compression Tool
Shielded CAT 5e, Plug w/Protective Boot	190061 (568A) 190062 (ISDN)	110340 - RJ45 Crimp Tool
Shielded CAT 6, Plug w/ATUM Strain Relief (fits Amphenol (RJF) ruggedized backshell)	110788	110288 - RJ45 Crimp Tool 190048 - Insulation Compression Tool
Shielded CAT 6a, Jack w/ATUM Strain Relief	110939	110701 - Soft Jaw Clamping Pliers

As an ethernet data cable, E12424 will most often be terminated with RJ45 connectors. They are reliable, inexpensive and can trace a huge installed base virtually everywhere.

The insulation surrounding each conductor in E12424 is softer and thicker than common commercial-type ethernet cables. This is necessary to achieve data rate and maintain impedance in a shielded design. As a result, the larger diameter of this insulation will not easily enter a standard RJ45 connector cavity without modification.

PIC has designed special RJ45 type connectors designed to accommodate this larger insulation. Termination using these connectors is recommended and saves considerable time.

Note: Part 110274 has been replaced with 110340.

Call PIC For Availability

CABLE CONSTRUCTION

1. Fluoropolymer Jacket (Translucent Blue)
2. Silver-Plated Copper Braided Shield
3. Foil Shields
4. 2-Layer Solid/Foam Fluoropolymer Insulation
5. Tin-Plated Copper Drain Wire
6. Silver-Plated Copper Conductors

COLOR CODES

- Pair #1 - White w/Blue Inner, Blue w/White Inner
 Pair #2 - White w/Orange Inner, Orange w/White Inner

This cable has been specially designed by PIC for airborne high-speed data applications. The twisted-pair construction (two separate pairs) effectively reduces inductive interference while 100% foil (for each pair, as well as the entire cable) plus 90% braided shielding serve to further protect against EMI.*

Data transmission aboard aircraft faces more severe environmental and EMI situations than conventional LAN systems in commercial buildings, hence special measures have been taken to preserve technical performance.

Each conductor is surrounded by dual-layer foamed/solid fluoropolymer dielectric insulation having a high velocity of propagation. This permits smaller overall diameter and weight, at the same time retaining performance and required operating parameters. Removal of the outer foamed layer reveals the inner solid insulation of a diameter compatible with conventional RJ45 connector terminations.

Silver-plated copper conductors and shielding assure uniform conductivity with excellent solderability. A fluoropolymer jacket protects the cable against abrasion and environmental effects while maintaining flexibility for ease of installation.

E20424 exceeds ANSI/TIA-568-C.2 CAT 5e Channel Requirements. It is Skydrol resistant, RoHS compliant and passes the FAA flammability requirements of FAR Part 23 and 25, Appendix F. Test results are available upon request.

* The individual pair foil shields are also isolated from the overall foil shield for additional protection, hence the addition of the drain wire.

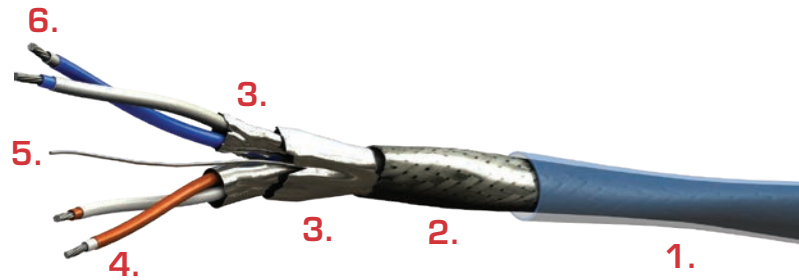

PHYSICAL DATA

- Conductors 24 AWG Stranded SPC
- Shield Coverage 100% (Foil), 90% (Braid)
- Operating Temperature -55° to +200°C
- Outer Diameter: in (mm) 0.27 (6.73)
- Minimum Bend Radius: in (mm) 1.30 (33.02)
- Weight: lbs/100 ft (kg/100 m) 4.2 (6.2)

ELECTRICAL DATA

- Impedance: ohms 100
- Capacitance: pF/ft (m) 13.4 (44.0)
- Velocity of Propagation: % 76.0
- Dielectric Voltage Rating (kV RMS) 1.5
- DC Resistance: ohms/1000 ft (m) Max 28.5 (93.5)
- Max Distance*: ft (m) 296 (90)
- Attenuation: Nom / Max dB/100 ft (dB/100 m)
 - @10 MHz 2.2 / 2.4 (7.2 / 7.7)
 - @100 MHz 7.6 / 8.0 (24.9 / 26.2)

All values nominal unless otherwise noted
 *Note: The max distance is based on maximum channel insertion loss per ANSI/TIA-568-C.2

Description	Connector P/N	Tool P/N
Shielded CAT 6, Plug w/ATUM Strain Relief	110787	110288 - RJ45 Crimp Tool
Shielded CAT 6, Plug w/Strain Relief Sleeve	110303	110288 - RJ45 Crimp Tool
Shielded CAT 6, Plug w/Protective Boot	110339	110288 - RJ45 Crimp Tool
Shielded CAT 6 Plug w/ATUM Strain Relief (fits fits Amphenol (RJF) ruggedized backshell)	110361	110288 - RJ45 Crimp Tool
Shielded CAT 6a, 90° Plug w/ATUM Strain Relief	110912 (568A) 110900 (568B)	110701 - Soft Jaw Clamping Pliers
Shielded CAT 6a, Plug w/Clamp Nut Strain Relief	110973 (568A) 110975 (568B)	110701 - Soft Jaw Clamping Pliers
Shielded CAT 6a, Jack w/ATUM Strain Relief	110937 (568A) 110938 (568B)	110701 - Soft Jaw Clamping Pliers
Shielded CAT 6, Plug, Blade Patch	110384	N/A

E20424 is normally terminated with RJ45 connectors. PIC has a wide variety of RJ45 connectors available including those listed above.

E20424 is also compatible with the innovative RJ45 BladePatch connector. The BladePatch connector features a unique design that locks into a standard RJ45 jack without using the standard RJ45 locking tab that is difficult to access and easy to break. Simply push the Blade-Patch connector into the jack to lock, pull back on the connector body to release. This connector is only available in assemblies built by PIC Wire & Cable. Please contact PIC Wire & Cable for more information.

E20424 may also be terminated into miniature circulator connectors such as the Mighty Mouse connector made by GlenAir. These connectors provide a durable ruggedized solution option to the RJ45. Contact PIC Wire & Cable for more information about these connectors.

Call PIC For Availability

CABLE CONSTRUCTION

1. PTFE Tape Jacket (White) Laser Markable
2. Silver-Plated Copper Braided Shield
3. PTFE Tape Binder
4. Solid PFA Conductor Insulation
5. Silver-Plated High Strength Copper Alloy Conductors

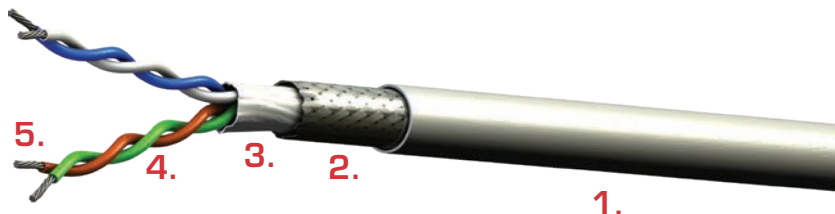

COLOR CODES

Pair #1 - White/Blue

Pair #2 - Green/Orange

PIC's DataMATES Ethernet cables incorporate innovative design features that provide maximum electrical performance in a small, light weight and flexible package. Using 26 AWG silver-plated, high strength copper alloy conductors and a laser markable PTFE jacket, PIC's E13426 delivers CAT 5e performance up to 224 ft with up to 45% less weight and up to 50% more flexibility.

Data transmission aboard aircraft faces more severe environmental and EMI situations than conventional LAN systems in commercial buildings, hence special measures have been taken to preserve technical performance. Silver-plated copper conductors and shielding assure uniform conductivity with excellent solderability. An PTFE jacket protects the cable against abrasion and environmental effects while maintaining flexibility for ease of installation.

E13426 is ideal for harsh environment applications that demand high reliability, maximum flexibility and light weight, such as cabin management, in-flight entertainment, internet backbones. It is Skydrol resistant, RoHS compliant and passes the FAA flammability requirements of FAR Part 23 and 25, Appendix F.

PHYSICAL DATA

- Conductors 26 AWG (19/38) Stranded SPCA
- Shield Coverage 80% (Braid)
- Operating Temperature -55° to +200°C
- Outer Diameter: in (mm) 0.16 (3.99)
- Minimum Bend Radius: in (mm) 0.50 (12.70)
- Weight: lbs/100 ft (kg/100 m) 2.0 (2.9)

ELECTRICAL DATA

- Impedance: ohms 100
- Capacitance: pF/ft (m) 14.5 (47.6)
- Velocity of Propagation: % 70.0
- Dielectric Voltage Rating (kV RMS) 1.5
- DC Resistance: ohms/1000 ft (m) Max 44.8 (147.0)
- Max Distance*: ft (m) 224 (68)
- Attenuation: Nom / Max dB/100 ft (dB/100 m)
 - @10 MHz 2.7 / 3.1 (9.8 / 10.2)
 - @100 MHz 8.7 / 10.5 (28.5 / 34.4)

All values nominal unless otherwise noted
 *Note: The max distance is based on maximum channel insertion loss per ANSI/TIA-568-C.2

Description	Connector P/N	Tool P/N
Shielded CAT 5e, Plug w/ATUM Strain Relief	110506	110288 - RJ45 Crimp Tool
Shielded CAT 5e, Plug w/Protective Boot	110726	110288 - RJ45 Crimp Tool
Shielded CAT 6, Plug w/ATUM Strain Relief (fits Amphenol (RJF) ruggedized backshell)	110789	110288 - RJ45 Crimp Tool
Shielded CAT 6a, Jack w/ATUM Strain Relief	110939	110701 - Soft Jaw Clamping Pliers
Siemon CAT 7 (Tera) Plug, 2 Pair, 26 AWG	110815*	110701 - Soft Jaw Clamping Pliers

Call PIC For Availability

CABLE CONSTRUCTION

1. ETFE Jacket (White) Laser Markable
2. Silver-Plated Copper Round Braid Shield
3. Aluminum/Polyester (Each Pair)
4. Foamed Fluoropolymer Insulation
5. Silver-Plated High Strength Copper Alloy Conductors

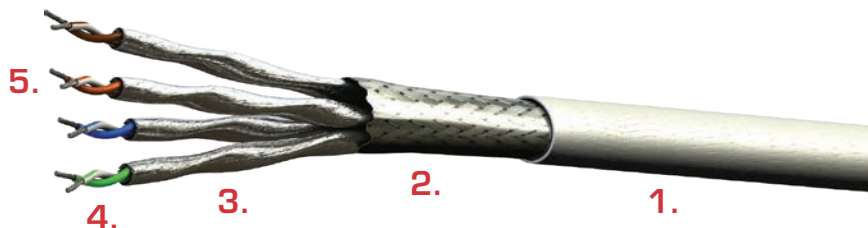

COLOR CODES

- Pair #1: Blue, White/Blue
 Pair #2: Green, White/Green
 Pair #3: Brown, White/Brown
 Pair #4: Orange, White/Orange

PIC's DataMATES Ethernet cables incorporate innovative design features that provide maximum electrical performance in a small, lightweight, flexible package.

Each pair uses a SP High Strength Copper alloy conductor and is individually shielded. PIC's E74824 cable delivers 10 Gbit performance per ISO 11801, Class F Channel requirements.

E74824 cable cannot only be used for 10 Gbit Ethernet applications but also can be used for video applications because of the low skew between each pair (3 nS /90m nom).

An ETFE jacket which is laser-markable, passed EN3475-503 Scrape Abrasion testing and is also very flexible for ease of installation.

E74824 is ideal for harsh environment applications that demand high reliability, maximum flexibility and light weight, such as cabin management, in-flight entertainment, internet backbones. It is Skydrol resistant, RoHS compliant and passes the FAA flammability requirements of FAR Part 23 and 25, Appendix F.

PHYSICAL DATA

- Conductors 24 AWG (19/36) Stranded SPCA
- Shield Coverage 100% (Foil), 90% (Braid)
- Operating Temperature -55° to +200°C
- Outer Diameter: in (mm) 0.28 (7.11)
- Minimum Bend Radius: in (mm) 2.20 (55.88)
- Weight: lbs/100 ft (kg/100 m) 4.7 (7.0)

ELECTRICAL DATA

- Impedance: ohms 100
- Capacitance: pF/ft (m) 13.0 (42.7)
- Velocity of Propagation: % 78.0
- Dielectric Voltage Rating (kV RMS) 0.9
- DC Resistance: ohms/1000 ft (m) Max 28.4 (93.2)
- Max Distance: ft (m) 296 (90)
- Attenuation: Nom / Max dB/100 ft (dB/100 m)
 - @100 MHz 6.6 / 7.0 (21.7 / 23.0)
 - @250 MHz 10.8 / 11.4 (35.4 / 37.4)
 - @500 MHz 15.7 / 16.6 (51.5 / 54.5)
 - @600 MHz 17.5 / 18.4 (57.4 / 60.4)

*All values nominal unless otherwise noted
 Note: The max distance is based on maximum channel insertion loss per ISO 11801, Class F*

Description	Connector P/N	Tool P/N
Shielded CAT 6a, 90° Plug w/ATUM Strain Relief	110912 (568A) 110900 (568B)	110701 - Soft Jaw Clamping Pliers
Shielded CAT 8.1, RJ45 Plug	111107 (568B)	110701 - Soft Jaw Clamping Pliers
Shielded CAT 8.1, RJ45 Jack	111109 (568B)	110701 - Soft Jaw Clamping Pliers
Siemon CAT 7 (Tera) Plug, 4 Pair, 24 AWG	110807	110701 - Soft Jaw Clamping Pliers
Siemon CAT 7 (Tera) Jack, 4 Pair, 24 AWG	110808	110701 - Soft Jaw Clamping Pliers

E74824 is an ethernet cable that can be terminated in a variety of ways.

This cable can be terminated into the RJ45 connectors referenced above.

Call PIC For Availability

CABLE CONSTRUCTION

1. ETFE Jacket (White) Laser Markable
2. Silver-Plated Copper Round Braid Shield
3. Aluminum/Polyester (Each Pair)
4. Foamed Fluoropolymer Insulation
5. Silver-Plated High Strength Copper Alloy Conductors

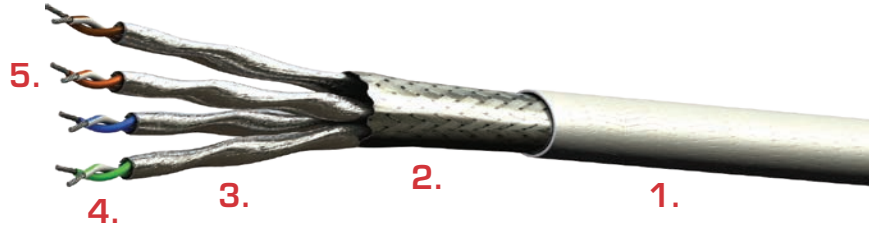

COLOR CODES

- Pair #1: Blue, White/Blue
 Pair #2: Green, White/Green
 Pair #3: Brown, White/Brown
 Pair #4: Orange, White/Orange

PIC's DataMATES Ethernet cables incorporate innovative design features that provide maximum electrical performance in a small, lightweight, flexible package.

Each pair uses a SP High Strength Copper alloy conductor and is individually shielded. PIC's E74826 cable delivers 10 Gbit performance per ISO 11801, Class F Channel requirements.

E74826 cable cannot only be used for 10 Gbit Ethernet applications but also can be used for video applications because of the low skew between each pair (3 nS /70m nom).

An ETFE jacket which is laser-markable, passed EN3475-503 Scrape Abrasion testing and is also very flexible for ease of installation.

E74826 is ideal for harsh environment applications that demand high reliability, maximum flexibility and light weight, such as cabin management, in-flight entertainment, internet backbones. It is Skydrol resistant, RoHS compliant and passes the FAA flammability requirements of FAR Part 23 and 25, Appendix F.

PHYSICAL DATA

- Conductors 26 AWG (19/38) Stranded SPCA
- Shield Coverage 100% (Foil), 90% (Braid)
- Operating Temperature -55° to +200°C
- Outer Diameter: in (mm) 0.23 (5.84)
- Minimum Bend Radius: in (mm) 1.80 (45.72)
- Weight: lbs/100 ft (kg/100 m) 3.3 (4.9)

ELECTRICAL DATA

- Impedance: ohms 100
- Capacitance: pF/ft (m) 13.0 (42.7)
- Velocity of Propagation: % 78.0
- Dielectric Voltage Rating (kV RMS) 0.9
- DC Resistance: ohms/1000 ft (m) Max 44.8 (147.0)
- Max Distance: ft (m) 230 (70)
- Attenuation: Nom / Max dB/100 ft (dB/100 m)
 - @100 MHz 7.5 / 9.0 (24.6 / 29.5)
 - @250 MHz 12.3 / 14.7 (40.4 / 48.2)
 - @500 MHz 17.8 / 21.4 (58.4 / 70.2)
 - @600 MHz 22.5 / 23.7 (73.8 / 77.8)

*All values nominal unless otherwise noted
 Note: The max distance is based on maximum channel insertion loss per ISO 11801, Class F*

Description	Connector P/N	Tool P/N
Shielded CAT 6a, 90° Plug w/ATUM Strain Relief	110912 (568A) 110900 (568B)	110701 - Soft Jaw Clamping Pliers
Shielded CAT 6a, Jack w/ATUM Strain Relief	110937 (568A) 110938 (568B)	110701 - Soft Jaw Clamping Pliers
Shielded CAT 8.1, RJ45 Plug	111112 (568B)	110701 - Soft Jaw Clamping Pliers
Siemon CAT 7 (Tera) Plug, 4 Pair, 26 AWG	110811	110701 - Soft Jaw Clamping Pliers
Siemon CAT 7 (Tera) Jack, 4 Pair, 26 AWG	110813	110701 - Soft Jaw Clamping Pliers

E74826 is an ethernet cable that can be terminated in a variety of ways.

This cable can be terminated into the RJ45 connectors referenced above.

Call PIC For Availability

CABLE CONSTRUCTION

1. PTFE Tape Jacket (White) Laser Markable
2. Silver-Plated Copper Braided Shield
3. Foil Shield
4. PTFE Tape Binder
5. Fluoropolymer Insulation
6. Fluoropolymer Spline
7. Silver-Plated High Strength Copper Alloy Conductors

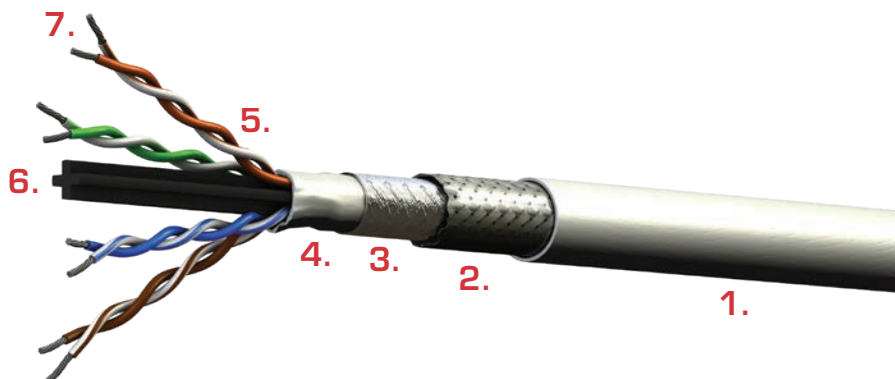

COLOR CODES

- Pair #1 - Blue, White/Blue
- Pair #2 - Orange, White/Orange
- Pair #3 - Green, White/Green
- Pair #4 - Brown, White/Brown

PIC's DataMATES Ethernet cables incorporate innovative design features that provide maximum electrical performance in a small, light weight and flexible package. PIC's E6A6824 delivers 10 Gigabit (ANSI/TIA-568 Category 6a) performance up to 246 ft.

Data transmission aboard aircraft faces more severe environmental and EMI situations than conventional LAN systems in commercial buildings, hence special measures have been taken to preserve technical performance. Silver-plated copper conductors and shielding assure uniform conductivity with excellent solderability. An PTFE jacket which is laser markable passed EN3475-503 Scrape Abrasion testing and is also flexible for ease of installation.

E6A6824 is ideal for harsh environment applications that demand high reliability, maximum flexibility and light weight, such as cabin management, in-flight entertainment, internet backbones. It is Skydrol resistant, RoHS compliant and passes the FAA flammability requirements of FAR Part 23 and 25, Appendix F.

PHYSICAL DATA

- Conductors 24 AWG (19/36) Stranded SPCA
- Shield Coverage 100% (Foil), 80% (Braid)
- Operating Temperature -55° to +200°C
- Outer Diameter: in (mm) 0.26 (6.60)
- Minimum Bend Radius: in (mm) 0.78 (19.81)
- Weight: lbs/100 ft (kg/100 m) 4.4 (6.5)

ELECTRICAL DATA

- Impedance: ohms 100
- Capacitance: pF/ft (m) 14.5 (47.6)
- Velocity of Propagation: % 70.0
- Dielectric Voltage Rating (kV RMS) 1.5
- DC Resistance: ohms/1000 ft (m) Max 28.4 (93.2)
- Max Distance*: ft (m) 246 (75)
- Attenuation: Nom / Max dB/100 ft (dB/100 m)
 - @10 MHz 2.3 / 2.6 (7.5 / 8.5)
 - @100 MHz 7.0 / 8.4 (23.0 / 27.6)
 - @250 MHz 11.4 / 13.7 (37.4 / 44.9)
 - @500 MHz 16.5 / 20.0 (58.1 / 65.6)

All values nominal unless otherwise noted
 *Note: The max distance is based on maximum channel insertion loss per ANSI/TIA-568-C.2

Description	Connector P/N	Tool P/N
Shielded CAT 6, Plug w/ATUM Strain Relief	111170	111183 - RJ45 Crimp Tool
Shielded CAT 6, Plug w/Strain Relief Sleeve	111171	111183 - RJ45 Crimp Tool
Shielded CAT 6, Plug w/Protective Boot	111172	111183 - RJ45 Crimp Tool
Shielded CAT 6, Plug w/ATUM Strain Relief (fits Amphenol (RJF) ruggedized backshell)	111173	111183 - RJ45 Crimp Tool
Shielded CAT 6a, 90° Plug w/ATUM Strain Relief	110912 (568A) 110900 (568B)	110701 - Soft Jaw Clamping Pliers
Shielded CAT 6a, Plug w/Clamp Nut Strain Relief	110973 (568A) 110975 (568B)	110701 - Soft Jaw Clamping Pliers
Shielded CAT 6a, Jack w/ATUM Strain Relief	110937 (568A) 110938 (568B)	110701 - Soft Jaw Clamping Pliers
Siemon CAT 7 (Tera) Plug, 4 Pair, 24 AWG	110807*	110701 - Soft Jaw Clamping Pliers
Siemon CAT 7 (Tera) Jack, 4 Pair, 24 AWG	110808*	110701 - Soft Jaw Clamping Pliers

E6A6824 is a tested and qualified Ethernet cable for PIC Wire & Cable's MACHFORCE™ D38999 style high-speed Ethernet 10G connector.

Call PIC For Availability

CABLE CONSTRUCTION

1. PTFE Tape Jacket (White) Laser Markable
2. Silver-Plated Copper Braided Shield
3. Foil Shields
4. Foamed Fluoropolymer Insulation
5. Silver-Plated High Strength Copper Alloy Conductors

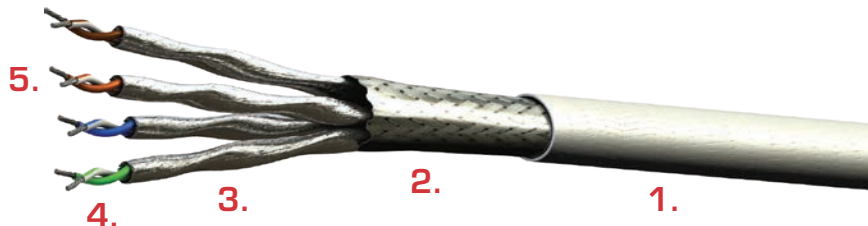

COLOR CODES

- Pair #1: Blue, White/Blue
- Pair #2: Orange, White/Orange
- Pair #3: Green, White/Green
- Pair #4: Brown, White/Brown

PIC's DataMATES Ethernet cables incorporate innovative design features that provide maximum electrical performance in a small, lightweight, flexible package.

Each pair uses a SP High Strength Copper alloy conductor and is individually shielded. PIC's E6A5824 cable delivers 10 Gbit performance per ANSI/TIA-568-C.2 Category 6a Channel requirements.

E6A5824 cable cannot only be used for Cat 6a, 10 Gbit Ethernet applications but also can be used for video applications because of the low skew between each pair (3 nS nom).

A PTFE tape jacket which is laser-markable, passed EN3475-503 Scrape Abrasion testing and is also very flexible for ease of installation.

E6A5824 is ideal for harsh environment applications that demand high reliability, maximum flexibility and light weight, such as cabin management, in-flight entertainment, internet backbones. It is Skydrol resistant, RoHS compliant and passes the FAA flammability requirements of FAR Part 23 and 25, Appendix F.

PHYSICAL DATA

- Conductors 24 AWG (19/36) Stranded SPCA
- Shield Coverage 100% (Foil), 90% (Braid)
- Operating Temperature -55° to +200°C
- Outer Diameter: in (mm) 0.26 (6.60)
- Minimum Bend Radius: in (mm) 1.30 (33.02)
- Weight: lbs/100 ft (kg/100 m) 4.2 (6.3)

ELECTRICAL DATA

- Impedance: ohms 100
- Capacitance: pF/ft (m) 13.0 (42.7)
- Velocity of Propagation: % 80.0
- Dielectric Voltage Rating (kV RMS) 0.9
- DC Resistance: ohms/1000 ft (m) Max 28.4 (93.2)
- Max Distance*: ft (m) 296 (90)
- Inter-Pair Delay Skew (between pairs) 3 nS/90m nom
- Attenuation: Nom / Max dB/100 ft (dB/100 m)
 - @10 MHz 1.9 / 2.1 (6.2 / 6.9)
 - @100 MHz 6.6 / 7.0 (21.7 / 23.0)
 - @250 MHz 10.8 / 11.4 (35.4 / 37.4)
 - @500 MHz 15.7 / 16.6 (51.5 / 54.5)

All values nominal unless otherwise noted
 *Note: The max distance is based on maximum channel insertion loss per ANSI/TIA-568-C.2

Description	Connector P/N	Tool P/N
Shielded CAT 6a, 90° Plug w/ATUM Strain Relief	110912 (568A) 110900 (568B)	110701 - Soft Jaw Clamping Pliers
Shielded CAT 6a, Plug w/Clamp Nut Strain Relief	110973 (568A) 110975 (568B)	110701 - Soft Jaw Clamping Pliers
Shielded CAT 6a, Jack w/ATUM Strain Relief	110937 (568A) 110938 (568B)	110701 - Soft Jaw Clamping Pliers
Siemon CAT 7 (Tera) Plug, 4 Pair, 24 AWG	110807*	110701 - Soft Jaw Clamping Pliers
Siemon CAT 7 (Tera) Jack, 4 Pair, 24 AWG	110808*	110701 - Soft Jaw Clamping Pliers

E6A5824 is a Category 6a (10Gb) ethernet cable that can be terminated in a variety of ways.

This cable can be terminated into the RJ45 connectors referenced above.

Call PIC For Availability

CABLE CONSTRUCTION

1. Fluoropolymer Jacket (Translucent Blue)
2. Silver-Plated Copper Braided Shield
3. Foil Shield
4. PTFE Tape Binder
5. Fluoropolymer Insulation
6. Fluoropolymer Spline
7. Silver-Plated Copper Conductors

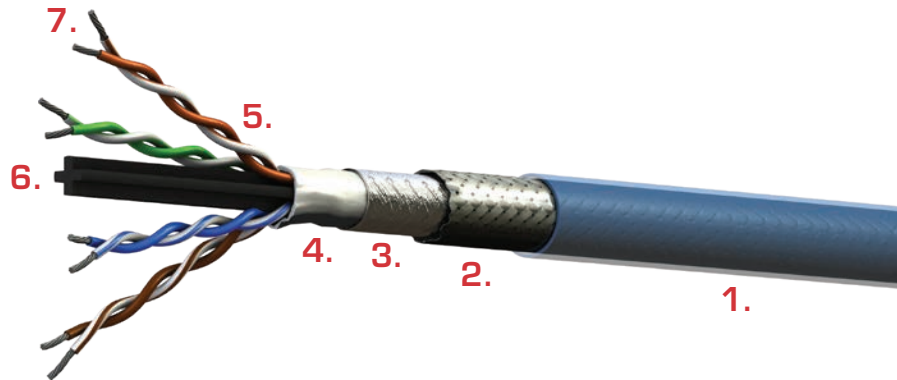

COLOR CODES

- Pair #1 - Blue, White/Blue
- Pair #2 - Orange, White/Orange
- Pair #3 - Green, White/Green
- Pair #4 - Brown, White/Brown

This cable has been specially designed by PIC for airborne 10 Gigabit Ethernet Local Area Network applications. The twisted-pair construction (four separate pairs) effectively reduces inductive interference while 100% foil and 90% braided shielding serve to further protect against EMI.

Data transmission aboard aircraft faces more severe environmental and EMI situations than conventional LAN systems in commercial buildings, hence special measures have been taken to preserve technical performance. Silver-plated copper conductors and shielding assure uniform conductivity with excellent solderability. A fluoropolymer jacket protects the cable against abrasion and environmental effects while maintaining flexibility for ease of installation.

E6A0824 exceeds ANSI/TIA-568-C.2 CAT 6a Channel Requirements. It is Skydrol resistant, RoHS compliant and passes the FAA flammability requirements of FAR Part 23 and 25, Appendix F. Test results are available upon request.

PHYSICAL DATA

• Conductors	24 AWG Stranded SPC
• Shield Coverage	100% (Foil), 90% (Braid)
• Operating Temperature	-55° to +200°C
• Outer Diameter: in (mm)	0.28 (6.99)
• Minimum Bend Radius: in (mm)	1.40 (35.56)
• Weight: lbs/100 ft (kg/100 m)	5.3 (7.9)

ELECTRICAL DATA

• Impedance: ohms	100	
• Capacitance: pF/ft (m)	14.5 (47.6)	
• Velocity of Propagation: %	70.0	
• Dielectric Voltage Rating (kV RMS)	1.5	
• DC Resistance: ohms/1000 ft (m) Max	28.5 (93.5)	
• Max Distance*: ft (m)	246 (75)	
• Attenuation: Nom / Max	dB/100 ft	(dB/100 m)
• @10 MHz	2.2 / 2.6	(7.2 / 8.5)
• @100 MHz	6.8 / 8.2	(22.3 / 26.9)
• @250 MHz	10.9 / 13.1	(35.8 / 43.0)
• @500 MHz	15.6 / 18.7	(51.2 / 61.4)

All values nominal unless otherwise noted
 *Note: The max distance is based on maximum channel insertion loss per ANSI/TIA-568-C.2

Description	Connector P/N	Tool P/N
Shielded CAT 6, Plug w/ATUM Strain Relief	111170	111183 - RJ45 Crimp Tool
Shielded CAT 6, Plug w/Strain Relief Sleeve	111171	111183 - RJ45 Crimp Tool
Shielded CAT 6, Plug w/Protective Boot	111172	111183 - RJ45 Crimp Tool
Shielded CAT 6, Plug w/ATUM Strain Relief (fits Amphenol (RJF) ruggedized backshell)	111173	111183 - RJ45 Crimp Tool
Shielded CAT 6a, 90° Plug w/ATUM Strain Relief	110912 (568A) 110900 (568B)	110701 - Soft Jaw Clamping Pliers
Shielded CAT 6a, Plug w/Clamp Nut Strain Relief	110973 (568A) 110975 (568B)	110701 - Soft Jaw Clamping Pliers
Shielded CAT 6a, Jack w/ATUM Strain Relief	110937 (568A) 110938 (568B)	110701 - Soft Jaw Clamping Pliers
Siemon CAT 7 (Tera) Plug, 4 Pair, 24 AWG	110807*	110701 - Soft Jaw Clamping Pliers
Siemon CAT 7 (Tera) Jack, 4 Pair, 24 AWG	110808*	110701 - Soft Jaw Clamping Pliers

E6A0824 is a Category 6a (10Gb) ethernet cable that can be terminated in a variety of ways.

E6A0824 may also be terminated into miniature circulator connectors such as the Mighty Mouse connector made by GlenAir. These connectors provide a durable ruggedized solution option to the RJ45. Contact PIC Wire & Cable for more information about these connectors.

Call PIC For Availability

CABLE CONSTRUCTION

1. ETFE Jacket (White) Laser Markable
2. Tin-Plated Copper Braided Shield
3. Foil Shield
4. PTFE Tape Binder
5. Fluoropolymer Insulation
6. Fluoropolymer Spline
7. Tin-Plated Copper Conductors

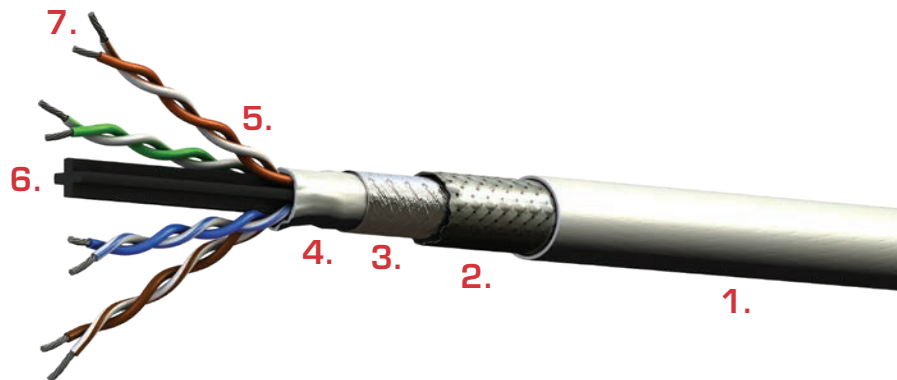

COLOR CODES

- Pair #1 - Blue, White/Blue
- Pair #2 - Orange, White/Orange
- Pair #3 - Green, White/Green
- Pair #4 - Brown, White/Brown

This cable has been specially designed by PIC for airborne 10 Gigabit Ethernet Local Area Network applications. The twisted-pair construction (four separate pairs) effectively reduces inductive interference while 100% foil and 85% braided shielding serve to further protect against EMI.

Data transmission aboard aircraft faces more severe environmental and EMI situation than conventional LAN systems in commercial buildings. Hence special measures have been taken to preserve technical performance.

Tin-plated copper conductors and shielding assure uniform conductivity with excellent solderability. A fluoropolymer jacket protects the cable against abrasion and environmental effects while maintaining flexibility for ease of installation.

E6A2824 exceeds ANSI/TIA-568-C.2 CAT 6a Channel Requirements. It is Skydrol resistant, RoHS compliant and passes the FAA flammability requirements of FAR Part 23 and 25, Appendix F. Test results are available upon request.

PHYSICAL DATA

- Conductors 24 AWG Stranded TPC
- Shield Coverage 100% (Foil), 85% (Braid)
- Operating Temperature -55° to +150°C
- Outer Diameter: in (mm) 0.28 (6.99)
- Minimum Bend Radius: in (mm) 1.40 (35.56)
- Weight: lbs/100 ft (kg/100 m) 4.6 (6.8)

ELECTRICAL DATA

- Impedance: ohms 100
- Capacitance: pF/ft (m) 14.5 (47.6)
- Velocity of Propagation: % 70.0
- Dielectric Voltage Rating (kV RMS) 1.5
- DC Resistance: ohms/1000 ft (m) Max 28.5 (93.5)
- Max Distance*: ft (m) 214 (65)
- Attenuation: Nom / Max dB/100 ft (dB/100 m)
 - @10 MHz 2.4 / 2.8 (7.9 / 9.2)
 - @100 MHz 7.5 / 9.0 (24.6 / 29.5)
 - @250 MHz 11.7 / 14.0 (38.4 / 45.9)
 - @500 MHz 18.9 / 22.7 (62.0 / 74.5)

*All values nominal unless otherwise noted
 Note: The max distance is based on maximum channel insertion loss per ANSI/TIA-568-C.2

Description	Connector P/N	Tool P/N
Shielded CAT 6, Plug w/ATUM Strain Relief	111170	111183 - RJ45 Crimp Tool
Shielded CAT 6, Plug w/Strain Relief Sleeve	111171	111183 - RJ45 Crimp Tool
Shielded CAT 6, Plug w/Protective Boot	111172	111183 - RJ45 Crimp Tool
Shielded CAT 6, Plug w/ATUM Strain Relief (fits Amphenol (RJF) ruggedized backshell)	111173	111183 - RJ45 Crimp Tool
Shielded CAT 6a, 90° Plug w/ATUM Strain Relief	110912 (568A) 110900 (568B)	110701 - Soft Jaw Clamping Pliers
Shielded CAT 6a, Plug w/Clamp Nut Strain Relief	110973 (568A) 110975 (568B)	110701 - Soft Jaw Clamping Pliers
Shielded CAT 6a, Jack w/ATUM Strain Relief	110937 (568A) 110938 (568B)	110701 - Soft Jaw Clamping Pliers
Siemon CAT 7 (Tera) Plug, 4 Pair, 24 AWG	110807*	110701 - Soft Jaw Clamping Pliers
Siemon CAT 7 (Tera) Jack, 4 Pair, 24 AWG	110808*	110701 - Soft Jaw Clamping Pliers

E6A2824 is a Category 6a (10Gb) ethernet cable that can be terminated in a variety of ways.

E6A2824 may also be terminated into miniature circulator connectors such as the Mighty Mouse connector made by GlenAir. These connectors provide a durable ruggedized solution option to the RJ45. Contact PIC Wire & Cable for more information about these connectors.

Call PIC For Availability

CABLE CONSTRUCTION

1. Fluoropolymer Jacket (Translucent Blue)
2. Silver-Plated Copper Braided Shield
3. Foil Shield
4. Fluoropolymer Tape Binder
5. Fluoropolymer Insulation
6. Fluoropolymer Spline
7. Silver-Plated Copper Conductors

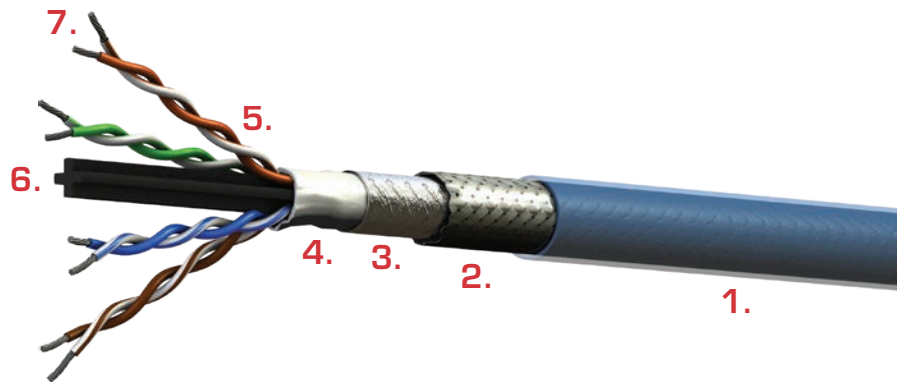

COLOR CODES

- Pair #1 - Blue, White/Blue
- Pair #2 - Orange, White/Orange
- Pair #3 - Green, White/Green
- Pair #4 - Brown, White/Brown

This cable has been specially designed by PIC for airborne Gigabit Ethernet Local Area Network applications. The twisted-pair construction (four separate pairs) effectively reduces inductive interference while 100% foil and 90% braided shielding serve to further protect against EMI.

Data transmission aboard aircraft faces more severe environmental and EMI situations than conventional LAN systems in commercial buildings, hence special measures have been taken to preserve technical performance. Silver-plated copper conductors and shielding assure uniform conductivity with excellent solderability. A fluoropolymer jacket protects the cable against abrasion and environmental effects while maintaining flexibility for ease of installation.

E50824 is Skydrol resistant, RoHS compliant and passes the FAA flammability requirements of FAR Part 23 and 25, Appendix F. Test results are available upon request.

Note: This product is also available with a black fluoropolymer jacket under product number G50824.

PHYSICAL DATA

• Conductors	24 AWG Stranded SPC
• Shield Coverage	100% (Foil), 90% (Braid)
• Operating Temperature	-55° to +200°C
• Outer Diameter: in (mm)	0.27 (6.73)
• Minimum Bend Radius: in (mm)	1.40 (35.56)
• Weight: lbs/100 ft (kg/100 m)	5.0 (7.4)

ELECTRICAL DATA

• Impedance: ohms	100
• Capacitance: pF/ft (m)	14.5 (47.6)
• Velocity of Propagation: %	70.0
• Dielectric Voltage Rating (kV RMS)	1.5
• DC Resistance: ohms/1000 ft (m) Max	28.5 (93.5)
• Max Distance*: ft (m)	268 (82)
• Attenuation: Nom / Max	dB/100 ft (dB/100 m)
• @10 MHz	2.2 / 2.6 (7.2 / 8.5)
• @100 MHz	6.8 / 8.2 (22.3 / 26.9)

All values nominal unless otherwise noted
**Note: The max distance is based on maximum channel insertion loss per ANSI/TIA-568-C.2*

Description	Connector P/N	Tool P/N
Shielded CAT 6, Plug w/ATUM Strain Relief	110787	110288 - RJ45 Crimp Tool
Shielded CAT 6, Plug w/Strain Relief Sleeve	110303	110288 - RJ45 Crimp Tool
Shielded CAT 6, Plug w/Protective Boot	110339	110288 - RJ45 Crimp Tool
Shielded CAT 6 Plug w/ATUM Strain Relief (fits fits Amphenol (RJF) ruggedized backshell)	110361	110288 - RJ45 Crimp Tool
Shielded CAT 6a, 90° Plug w/ATUM Strain Relief	110912 (568A) 110900 (568B)	110701 - Soft Jaw Clamping Pliers
Shielded CAT 6a, Plug w/Clamp Nut Strain Relief	110973 (568A) 110975 (568B)	110701 - Soft Jaw Clamping Pliers
Shielded CAT 6a, Jack w/ATUM Strain Relief	110937 (568A) 110938 (568B)	110701 - Soft Jaw Clamping Pliers
Shielded CAT 6, Plug, Blade Patch	110384	N/A

E50824 is normally terminated with RJ45 connectors. PIC has a wide variety of RJ45 connectors available including those listed above.

E50824 is also compatible with the innovative RJ45 BladePatch connector. The BladePatch connector features a unique design that locks into a standard RJ45 jack without using the standard RJ45 locking tab that is difficult to access and easy to break. Simply push the Blade-Patch connector into the jack to lock, pull back on the connector body to release. This connector is only available in assemblies built by PIC Wire & Cable. Please contact PIC Wire & Cable for more information.

E50824 may also be terminated into miniature circulator connectors such as the Mighty Mouse connector made by GlenAir. These connectors provide a durable ruggedized solution option to the RJ45. Contact PIC Wire & Cable for more information about these connectors.

Call PIC For Availability

CABLE CONSTRUCTION

1. ETFE Jacket (White) Laser Markable
2. Silver-Plated Copper Round Braid Shields
3. Foil Shield
4. ETFE Jackets (White)
5. Foamed Fluoropolymer Insulation
6. Silver-Plated High Strength Copper Alloy Conductors

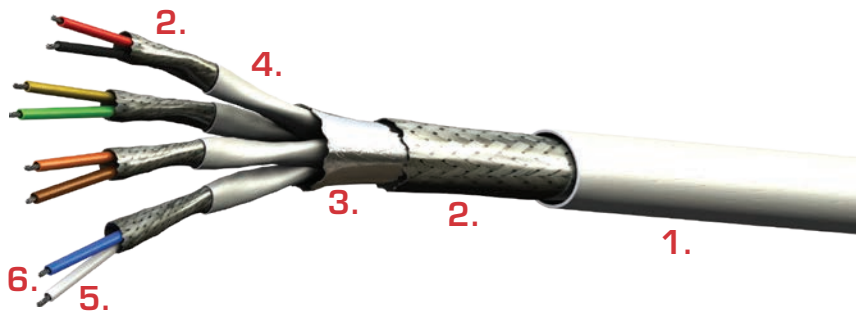

COLOR CODES

- Pair #1 - White/Blue
 Pair #2 - Yellow/Green
 Pair #3 - Red/Black
 Pair #4 - Orange/Brown

This cable has been specially designed by PIC for airborne high-speed data applications. The twisted-pair construction (four separate pairs) effectively reduces inductive interference while 100% foil (for each pair) plus braided shielding over each pair and an overall shield serves to further protect against EMI.

DV0824 cable has 4 pairs which were designed to have a low skew between pairs for high performance video applications. The low skew between each pair ensures the signal sent down each pair reaches the other end at approximately the same time.

Conductor insulation consists of foamed fluoropolymer, having a higher velocity of propagation. This assures correct impedance matching, thus minimizing reflection — important in high-speed data applications. This permits smaller overall diameter and weight, at the same time retaining performance and required operating parameters. Each pair is individually shielded and jacketed to isolate it from the other pairs.

Silver-plated copper conductors and shielding assure uniform conductivity with excellent solderability. An ETFE jacket protects the cable against abrasion and environmental effects while maintaining flexibility for ease of installation.

It is Skydrol resistant, RoHS compliant and passes the FAA flammability requirements of FAR Part 23 and 25, Appendix F. Test results are available upon request.

PHYSICAL DATA

- Conductors 24 AWG Stranded SPC
- Shield Coverage 100% (Foil), 80% (Braid), 95% (Overall)
- Operating Temperature -55° to +200°C
- Outer Diameter: in (mm) 0.35 (8.89)
- Minimum Bend Radius: in (mm) 1.75 (44.45)
- Weight: lbs/100 ft (kg/100 m) 7.7 (11.5)

ELECTRICAL DATA (each pair)

- Impedance: ohms 100
- Capacitance: pF/ft (m) 13.0 (42.7)
- Velocity of Propagation: % 80.0
- Dielectric Voltage Rating (kV RMS) 0.9
- DC Resistance: ohms/1000 ft (m) Max 28.5 (93.5)
- Skew (Inter-pair) pS/ft 14.0 (45.3)
- Attenuation: Nom / Max dB/100 ft (dB/100 m)
 - @10 MHz 2.4 / 2.7 (7.9 / 8.9)
 - @100 MHz 8.2 / 8.8 (26.9 / 28.9)

All values nominal unless otherwise noted

CABLE CONSTRUCTION

1. PTFE Tape Jacket (White) Laser Markable
2. Silver-Plated Copper Braided Shield
3. Foil Shield
4. PTFE Tape Binder
5. Fluoropolymer Insulation
6. Fluoropolymer Spline
7. Silver-Plated High Strength Copper Alloy Conductors

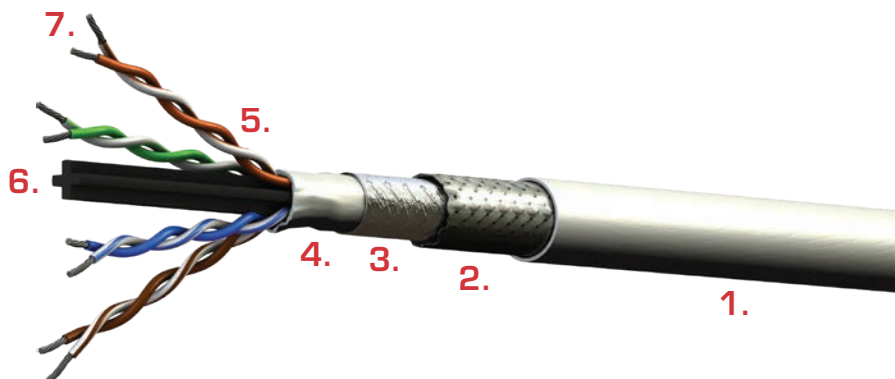

COLOR CODES

- Pair #1 - Blue, White/Blue
- Pair #2 - Orange, White/Orange
- Pair #3 - Green, White/Green
- Pair #4 - Brown, White/Brown

PIC's DataMATES Ethernet cables incorporate innovative design features that provide maximum electrical performance in a small, light weight and flexible package. PIC's E6A6826 delivers 10 Gigabit (ANSI/TIA-568 Category 6a) performance up to 214 ft.

Data transmission aboard aircraft faces more severe environmental and EMI situations than conventional LAN systems in commercial buildings, hence special measures have been taken to preserve technical performance. Silver-plated copper conductors and shielding assure uniform conductivity with excellent solderability. An PTFE jacket which is laser markable passed EN3475-503 Scrape Abrasion testing and is also flexible for ease of installation.

E6A6826 is ideal for harsh environment applications that demand high reliability, maximum flexibility and light weight, such as cabin management, in-flight entertainment, internet backbones. It is Skydrol resistant, RoHS compliant and passes the FAA flammability requirements of FAR Part 23 and 25, Appendix F.

PHYSICAL DATA

- Conductors 26 AWG (19/38) Stranded SPCA
- Shield Coverage 100% (Foil), 80% (Braid)
- Operating Temperature -55° to +200°C
- Outer Diameter: in (mm) 0.22 (5.59)
- Minimum Bend Radius: in (mm) 0.66 (16.76)
- Weight: lbs/100 ft (kg/100 m) 3.2 (4.8)

ELECTRICAL DATA

- Impedance: ohms 100
- Capacitance: pF/ft (m) 14.5 (47.6)
- Velocity of Propagation: % 70.0
- Dielectric Voltage Rating (kV RMS) 1.5
- DC Resistance: ohms/1000 ft (m) Max 44.8 (147.0)
- Max Distance*: ft (m) 214 (65)
- Attenuation: Nom / Max dB/100 ft (dB/100 m)
 - @10 MHz 2.6 / 3.0 (8.5 / 9.8)
 - @100 MHz 8.2 / 9.7 (26.9 / 31.8)
 - @250 MHz 13.2 / 15.8 (43.3 / 51.8)
 - @500 MHz 19.3 / 23.0 (63.3 / 75.5)

*All values nominal unless otherwise noted
Note: The max distance is based on maximum channel insertion loss per ANSI/TIA-568-C.2

Description	Connector P/N	Tool P/N
Shielded CAT 6, Plug w/ATUM Strain Relief	110731	110729 - RJ45 Crimp Tool
Shielded CAT 6, Plug w/Protective Boot	110725	110729 - RJ45 Crimp Tool
Shielded CAT 6, Plug w/ATUM Strain Relief (fits Amphenol (RJF) ruggedized backshell)	110790	110729 - RJ45 Crimp Tool
Shielded CAT 6a, 90° Plug w/ATUM Strain Relief	110913 (568A) 110904 (568B)	110701 - Soft Jaw Clamping Pliers
Shielded CAT 6a, Plug w/Clamp Nut Strain Relief	111007 (568A) 111009 (568B)	110701 - Soft Jaw Clamping Pliers
Shielded CAT 6a, Jack w/ATUM Strain Relief	110937 (568A) 110938 (568B)	110701 - Soft Jaw Clamping Pliers
Shielded CAT 6a, RJ45 Plug, Blade Patch	110845	N/A
Siemon CAT 7 (Tera) Plug, 4 Pair, 26 AWG	110811*	110701 - Soft Jaw Clamping Pliers
Siemon CAT 7 (Tera) Jack, 4 Pair, 24 AWG	110813*	110701 - Soft Jaw Clamping Pliers

E6A6826 is a tested and qualified Ethernet cable for PIC Wire & Cable's MACHFORCE™ D38999 style high-speed Ethernet 10G connector.

Call PIC For Availability

CABLE CONSTRUCTION

1. PTFE Tape Jacket (White) Laser Markable
2. Silver-Plated Copper Braided Shield
3. Foil Shields
4. Foamed Fluoropolymer Insulation
5. Silver-Plated High Strength Copper Alloy Conductors

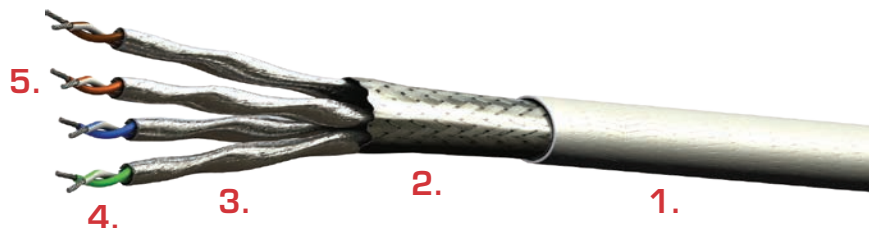

COLOR CODES

- Pair #1: Blue, White/Blue
- Pair #2: Orange, White/Orange
- Pair #3: Green, White/Green
- Pair #4: Brown, White/Brown

PIC's DataMATES Ethernet cables incorporate innovative design features that provide maximum electrical performance in a small, lightweight, flexible package.

Each pair uses a SP High Strength Copper alloy conductor and is individually shielded. PIC's E6A5826 cable delivers 10 Gbit performance per ANSI/TIA-568-C.2 Category 6a Channel requirements.

E6A5826 cable cannot only be used for Cat 6a, 10 Gbit Ethernet applications but also can be used for video applications because of the low skew between each pair (3 nS nom).

A PTFE tape jacket which is laser-markable, passed EN3475-503 Scrape Abrasion testing and is also very flexible for ease of installation.

E6A5826 is ideal for harsh environment applications that demand high reliability, maximum flexibility and light weight, such as cabin management, in-flight entertainment, internet backbones. It is Skydrol resistant, RoHS compliant and passes the FAA flammability requirements of FAR Part 23 and 25, Appendix F.

PHYSICAL DATA

- Conductors 26 AWG (19/38) Stranded SPCA
- Shield Coverage 100% (Foil), 90% (Braid)
- Operating Temperature -55° to +200°C
- Outer Diameter: in (mm) 0.21 (5.33)
- Minimum Bend Radius: in (mm) 1.10 (27.94)
- Weight: lbs/100 ft (kg/100 m) 3.0 (4.5)

ELECTRICAL DATA

- Impedance: ohms 100
- Capacitance: pF/ft (m) 12.0 (39.4)
- Velocity of Propagation: % 80.0
- Dielectric Voltage Rating (kV RMS) 0.9
- DC Resistance: ohms/1000 ft (m) Max 44.8 (147.0)
- Max Distance*: ft (m) Recommended 230 (70)
- Inter-Pair Delay Skew (between pairs) 3 nS/70m nom
- Attenuation: Nom / Max dB/100 ft (dB/100 m)
 - @10 MHz 2.4 / 2.8 (7.9 / 9.2)
 - @100 MHz 7.5 / 9.0 (24.5 / 29.5)
 - @250 MHz 12.3 / 14.7 (40.4 / 48.2)
 - @500 MHz 17.8 / 21.4 (58.4 / 70.2)

All values nominal unless otherwise noted
 *Note: The max distance is based on maximum channel insertion loss per ANSI/TIA-568-C.2

Description	Connector P/N	Tool P/N
Shielded CAT 6a, 90° Plug w/ATUM Strain Relief	110912 (568A) 110900 (568B)	110701 - Soft Jaw Clamping Pliers
Shielded CAT 6a, Plug w/Clamp Nut Strain Relief	110973 (568A) 110975 (568B)	110701 - Soft Jaw Clamping Pliers
Shielded CAT 6a, Jack w/ATUM Strain Relief	110937 (568A) 110938 (568B)	110701 - Soft Jaw Clamping Pliers
Siemon CAT 7 (Tera) Plug, 4 Pair, 26 AWG	110811*	110701 - Soft Jaw Clamping Pliers
Siemon CAT 7 (Tera) Jack, 4 Pair, 26 AWG	110813*	110701 - Soft Jaw Clamping Pliers

E6A5826 is a Category 6a (10Gb) ethernet cable that can be terminated in a variety of ways.

This cable can be terminated into the RJ45 connectors referenced above.

Call PIC For Availability

CABLE CONSTRUCTION

1. ETFE Jacket (White) Laser Markable
2. Tin-Plated Copper Outer Round Braid
3. Tin-Plated Copper Inner Flat Strip Braid
4. PTFE Tape Binder - White
5. Fluoropolymer Insulation
6. Fluoropolymer Filler
7. Silver-Plated High Strength Copper Alloy Conductors

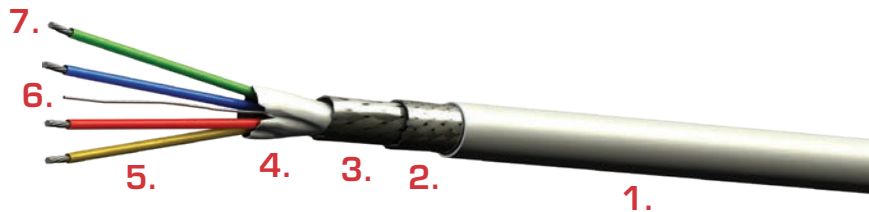

COLOR CODES

- Pair #1 - Red/Blue
 Pair #2 - Yellow/Green

This lightweight, low loss cable has been specially designed by PIC for airborne 100 Base-T data applications as defined by ARINC Specification 664.

The conductor insulation is foamed fluoropolymer making it small, light and low loss. Data transmission aboard aircraft faces more severe environmental and EMI situations than conventional LAN systems in commercial buildings, hence the double shielding to preserve technical performance. The cable is designed to be terminated with ARINC 600 and D38999 quad-type contacts. It is compatible with any contact designed for Tensolite cable part number NF24Q100.

An ETFE jacket protects the cable against abrasion and environmental effects while maintaining flexibility for ease of installation and is laser markable.

E51424 exceeds Category 5e requirements, is Skydrol resistant, RoHS compliant and passes the FAA flammability requirements of FAR Part 23 and 25, Appendix F. Test results are available upon request.

PHYSICAL DATA

- Conductors 24 AWG Stranded SPCA
- Shield Coverage 90% Inner (Braid), 85% Outer (Braid)
- Operating Temperature -55° to +150°C
- Outer Diameter: in (mm) 0.16 (4.06)
- Minimum Bend Radius: in (mm) 0.80 (20.32)
- Weight: lbs/100 ft (kg/100 m) 2.2 (3.3)

ELECTRICAL DATA

- Impedance: ohms 100
- Capacitance: pF/ft (m) 13.0 (42.7)
- Velocity of Propagation: % 80.0
- Dielectric Voltage Rating (kV RMS) 0.9
- DC Resistance: ohms/1000 ft (m) Max 28.5 (93.5)
- Max Distance*: ft (m) 255 (78)
- Attenuation: Nom / Max dB/100 ft (dB/100 m)
 - @10 MHz 2.3 / 2.7 (7.5 / 8.9)
 - @100 MHz 8.0 / 9.2 (26.2 / 30.2)

All values nominal unless otherwise noted
 *Note: The max distance is based on maximum channel insertion loss per ANSI/TIA-568-C.2

Description	Connector P/N	Tool P/N
Shielded CAT 5e, Plug w/ATUM Strain Relief	110558	110288 - RJ45 Crimp Tool
Shielded CAT 5e, Plug w/Protective Boot	110726	110288 - RJ45 Crimp Tool
Shielded CAT 6, Plug w/ATUM Strain Relief (fits Amphenol (RJF) ruggedized backshell)	110789	110288 - RJ45 Crimp Tool
Shielded CAT 6a, Jack w/ATUM Strain Relief	110939	110701 - Soft Jaw Clamping Pliers

Call PIC For Availability

CABLE CONSTRUCTION

1. Fluoropolymer Jacket (Translucent Blue)
2. Silver-Plated Copper Braided Shield
3. Foil Shield
4. PTFE Insulation
5. Silver-Plated Copper Conductors



COLOR CODES

Pair #1 - Red/Blue

Pair #2 - Yellow/Green

This cable has been specially designed by PIC for airborne high-speed data applications as defined by ARINC Specification 664.

Data transmission aboard aircraft faces more severe environmental and EMI situations than conventional LAN systems in commercial buildings, hence special measures have been taken to preserve technical performance.

Each conductor is surrounded by a fluoropolymer dielectric insulation and is designed to be terminated in with ARINC 600 and 38999 quadrax contacts. It is compatible with any contact designed for Draca Fileca cable P/N F4704.

A fluoropolymer jacket protects the cable against abrasion and environmental effects while maintaining flexibility for ease of installation.

E50424 exceeds Category 5e requirements, is Skydrol resistant, RoHS compliant and passes the FAA flammability requirements of FAR Part 23 and 25, Appendix F. Test results are available upon request.

PHYSICAL DATA

- | | |
|---------------------------------|--------------------------|
| • Conductors | 24 AWG Stranded SPC |
| • Shield Coverage | 100% (Foil), 85% (Braid) |
| • Operating Temperature | -55° to +200°C |
| • Outer Diameter: in (mm) | 0.17 (4.32) |
| • Minimum Bend Radius: in (mm) | 1.00 (25.40) |
| • Weight: lbs/100 ft (kg/100 m) | 2.7 (4.0) |

ELECTRICAL DATA

- | | |
|---------------------------------------|-------------------------|
| • Impedance: ohms | 100 |
| • Capacitance: pF/ft (m) | 13.0 (42.7) |
| • Velocity of Propagation: % | 69.5 |
| • Dielectric Voltage Rating (kV RMS) | 1.5 |
| • DC Resistance: ohms/1000 ft (m) Max | 24.2 (79.4) |
| • Max Distance*: ft (m) | 236 (72) |
| • Attenuation: Nom / Max | dB/100 ft (dB/100 m) |
| • @10 MHz | 2.2 / 3.0 (7.2 / 9.8) |
| • @100 MHz | 7.1 / 8.2 (23.3 / 26.9) |

All values nominal unless otherwise noted
**Note: The max distance is based on maximum channel insertion loss per ANSI/TIA-568-C.2*

Description	Connector P/N	Tool P/N
Shielded CAT 5e, Plug w/Strain Relief Sleeve	190007 (568A) 190015 (ISDN)	110340 - RJ45 Crimp Tool
Shielded CAT 5e, Plug w/Protective Boot	190061 (568A) 190062 (ISDN)	110340 - RJ45 Crimp Tool
Shielded CAT 6a, Jack w/ATUM Strain Relief	110939	110701 - Soft Jaw Clamping Pliers

Note: Part 110274 has been replaced with 110340.

Call PIC For Availability

CABLE CONSTRUCTION

1. ETFE Jacket (White) Laser Markable
2. Tin-Plated Copper Outer Round Braid
3. Tin-Plated Copper Inner Flat Strip Braid
4. PTFE Tape Binder - Clear
5. Fluoropolymer Insulation
6. Fluoropolymer Filler
7. Silver-Plated High Strength Copper Alloy Conductors

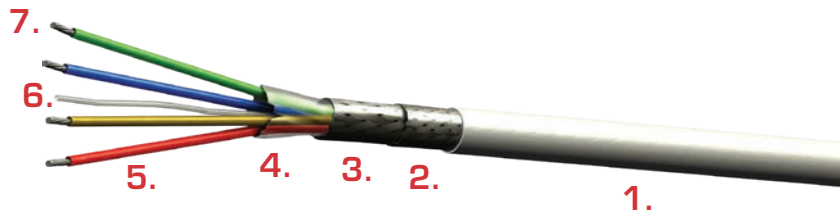

COLOR CODES

- Pair #1 - Red/Blue
 Pair #2 - Yellow/Green

This lightweight, low loss cable has been specially designed by PIC for airborne 100 Base-T data applications as defined by ARINC Specification 664.

Data transmission aboard aircraft faces more severe environmental and EMI situations than conventional LAN systems in commercial buildings, hence the double shielding to preserve technical performance. The cable is designed to be terminated with ARINC 600 and D38999 quad-type contacts. It is compatible with any contact designed for Tensolite cable part number NF26Q100.

An ETFE jacket protects the cable against abrasion and environmental effects while maintaining flexibility for ease of installation and is laser markable.

E51426 exceeds Category 5e requirements, is Skydrol resistant and meets the FAA flammability requirements of 14 CFR Part FAR 25.869(a)(4) Amdt 25-113 Appendix F Part I (a)(3).

PHYSICAL DATA

- Conductors 26 AWG (19/38) Stranded SPCA
- Shield Coverage 90% Inner (Braid), 85% Outer (Braid)
- Operating Temperature -55° to +150°C
- Outer Diameter: in (mm) 0.14 (3.48)
- Minimum Bend Radius: in (mm) 0.70 (17.78)
- Weight: lbs/100 ft (kg/100 m) 1.8 (2.7)

ELECTRICAL DATA

- Impedance: ohms 100
- Capacitance: pF/ft (m) 14.5 (47.6)
- Velocity of Propagation: % 70.0
- Dielectric Voltage Rating (kV RMS) 1.5
- DC Resistance: ohms/1000 ft (m) Max 44.8 (147.0)
- Max Distance*: ft (m) 214 (65)
- Attenuation: Nom / Max dB/100 ft (dB/100 m)
 - @10 MHz 2.8 / 3.2 (9.2 / 10.5)
 - @100 MHz 9.6 / 11.0 (31.5 / 36.1)

All values nominal unless otherwise noted
 *Note: The max distance is based on maximum channel insertion loss per ANSI/TIA-568-C.2

Description	Connector P/N	Tool P/N
Shielded CAT 5e, Plug w/ATUM Strain Relief	110731	110729 - RJ45 Crimp Tool
Shielded CAT 5e, Plug w/Protective Boot	110725	110729 - RJ45 Crimp Tool
Shielded CAT 6, Plug w/ATUM Strain Relief (fits Amphenol (RJF) ruggedized backshell)	110790	110729 - RJ45 Crimp Tool
Shielded CAT 6a, Jack w/ATUM Strain Relief	110939	110701 - Soft Jaw Clamping Pliers

Call PIC For Availability

CABLE CONSTRUCTION

1. PTFE Tape Jacket (White) Laser Markable
2. Silver-Plated Copper Round Braid Shield
3. PTFE Tape Binder - Clear
4. Solid PFA Insulation
5. Fluoropolymer Filler
6. Silver-Plated High Strength Copper Alloy Conductors

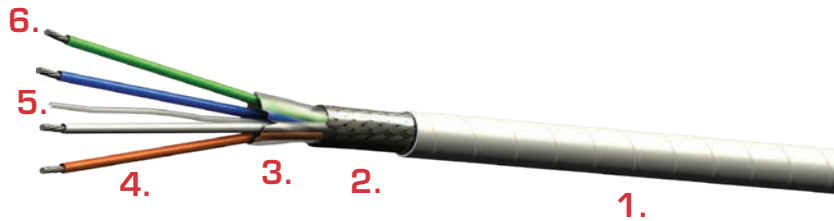

COLOR CODES

Pair #1 - White/Blue

Pair #2 - Orange/Green

This lightweight, low loss cable has been specially designed by PIC for airborne 100 Base-T data applications as defined by ARINC Specification 664.

Data transmission aboard aircraft faces more severe environmental and EMI situations than conventional LAN systems in commercial buildings, hence the shielding to preserve technical performance.

A PTFE tape jacket protects the cable against abrasion and environmental effects while maintaining flexibility for ease of installation and is laser markable.

E51428 exceeds Category 5e requirements, is Skydrol resistant and meets the FAA flammability requirements of 14 CFR Part FAR 25.869(a)(4) Amdt 25-113 Appendix F Part I (a)(3).

PHYSICAL DATA

- Conductors 28 AWG (7/36) Stranded SPCA
- Shield Coverage 80% (Braid)
- Operating Temperature -55° to +200°C
- Outer Diameter: in (mm) 0.11 (2.92)
- Minimum Bend Radius: in (mm) 0.60 (15.24)
- Weight: lbs/100 ft (kg/100 m) 1.0 (1.5)

ELECTRICAL DATA

- Impedance: ohms 100
- Capacitance: pF/ft (m) 14.5 (47.6)
- Velocity of Propagation: % 70.0
- Dielectric Voltage Rating (kV RMS) 1.5
- DC Resistance: ohms/1000 ft (m) Max 74.8 (245.4)
- Max Distance*: ft (m) 170 (51)
- Attenuation: Nom / Max dB/100 ft (dB/100 m)
 - @10 MHz 3.7 / 4.1 (12.1 / 13.5)
 - @100 MHz 11.1 / 12.4 (36.4 / 40.7)

All values nominal unless otherwise noted
 *Note: The max distance is based on maximum channel insertion loss per ANSI/TIA-568-C.2

CABLE CONSTRUCTION

1. PTFE Tape Jacket (White) Laser Markable
2. Silver-Plated Copper Braided Shield
3. Foil Shield
4. PTFE Tape Binder - White
5. Fluoropolymer Spline
6. PFA Insulation
7. Silver-Plated High Strength Copper Alloy Conductors
8. Silver-Plated Copper Conductors

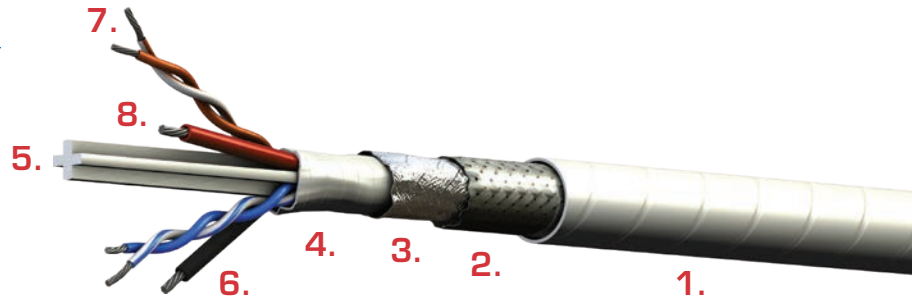

COLOR CODES

Pair #1 - Blue, White/Blue
 Pair #2 - Orange, White/Orange
 Power Conductors: Red, Black

This Power over Ethernet (PoE) cable incorporates innovative design features that provide maximum electrical performance in a small, lightweight, flexible package.

This cable is manufactured with a white PTFE tape jacket that is laser-markable and also very rugged, passing the abrasion testing of EN3475-503. The data pairs are manufactured using a high temp Fluoropolymer. The data pairs will perform at frequencies from CAT 5e, up to CAT 6a requirements.

Data transmission aboard aircraft faces more severe environmental and EMI situations than conventional LAN systems in commercial buildings, hence special measures have been taken to preserve technical performance. Silver-plated copper conductors and shielding assure uniform conductivity with excellent solderability.

E5E3624 is ideal for harsh environment applications that demand high reliability, maximum flexibility and light weight, such as cabin management, in-flight entertainment, internet backbones. It is Skydrol resistant, RoHS compliant and passes the FAA flammability requirements of FAR Part 23 and 25, Appendix F.

PHYSICAL DATA

- Conductors:
 - Data Pair 24 AWG Stranded SPCA
 - Power Pair 20 AWG Stranded SPC
- Shield Coverage: 90% (Braid)
- Operating Temperature: -55° to +200°C
- Outer Diameter: in (mm) 0.25 (6.35)
- Minimum Bend Radius: in (mm) 0.80 (20.32)
- Weight: lbs/100 ft (kg/100 m) 4.5 (6.7)

ELECTRICAL DATA

Data pair

- Impedance: ohms 100
- Capacitance: pF/ft (m) 14.0 (46.0)
- Velocity of Propagation: % 70.0
- Dielectric Voltage Rating (kV, RMS) Max 1.5
- DC Resistance: ohms/1000 ft (m) Max 28.5 (93.5)
- Max Distance*: ft (m) 268 (82)
- Attenuation: Nom / Max dB/100 ft (dB/100 m)
 - @10 MHz 2.2 / 2.6 (7.2 / 8.5)
 - @100 MHz 6.8 / 8.2 (22.3 / 26.9)

Power pair

- Dielectric Voltage Rating (V, rms) Max 600
- DC Resistance (ohms/1000 ft.) (m) Max 9.1 (29.9)

All values nominal unless otherwise noted
 *Note: The max distance is for a Cat 5e channel

CABLE CONSTRUCTION

1. ETFE Jacket (White) Laser Markable
2. Tin-Plated Copper Braided Shield
3. Tin-Plated Copper Drain Wire
4. Foil Shield
5. Solid Fluoropolymer Insulation
6. Foamed Fluoropolymer Insulation
7. Tin-Plated Copper Conductors

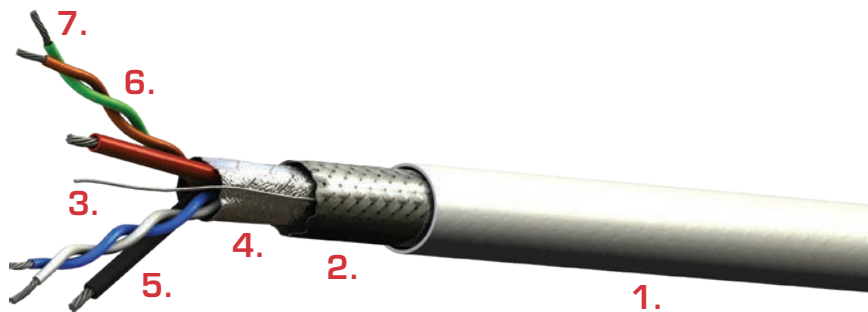

COLOR CODES

Pair #1 - White, Blue
 Pair #2 - Orange, Green
 Power Conductors: Red, Black

This Power over Ethernet (PoE) cable incorporates innovative design features that provide maximum electrical performance in a small, lightweight, flexible package.

This cable is manufactured with a white ETFE jacket that is laser-markable and also very rugged, passing the abrasion testing of EN3475-503. The data pairs are manufactured using a high temp Fluoropolymer. The data pairs will perform and exceed CAT 5e channel requirements up to 257'. Data transmission aboard aircraft faces more severe environmental and EMI situations than conventional LAN systems in commercial buildings, hence special measures have been taken to preserve technical performance.

E5E1724 is ideal for harsh environment applications that demand high reliability, maximum flexibility and light weight, such as cabin management, in-flight entertainment, internet backbones. It is Skydrol resistant, RoHS compliant and passes the FAA flammability requirements of FAR Part 23 and 25, Appendix F.

PHYSICAL DATA

- Conductors:
 - Data Pair 24 AWG Stranded TPC
 - Power Pair 22 AWG Stranded TPC
- Shield Coverage: 85% (Braid)
- Operating Temperature: -55° to +150°C
- Outer Diameter: in (mm) 0.21 (5.33)
- Minimum Bend Radius: in (mm) 1.00 (25.40)
- Weight: lbs/100 ft (kg/100 m) 3.5 (5.2)

ELECTRICAL DATA

Data pair

- Impedance: ohms 100
- Capacitance: pF/ft (m) 13.0 (42.7)
- Velocity of Propagation: % 80.0
- Dielectric Voltage Rating (kV, RMS) Max 0.9
- DC Resistance: ohms/1000 ft (m) Max 26.2 (86.0)
- Max Distance*: ft (m) 257 (78)
- Attenuation: Nom / Max dB/100 ft (dB/100 m)
 - @10 MHz 2.3 / 2.7 (7.5 / 8.9)
 - @100 MHz 6.8 / 7.5 (22.3 / 24.6)

Power pair

- Dielectric Voltage Rating (kV, RMS) Max 0.6
- DC Resistance (ohms/1000 ft.) (m) Max 16.2 (53.1)

All values nominal unless otherwise noted
 *Note: The max distance is for a Cat 5e channel



PIC DataMATES® include high speed data cables specially designed for Airborne USB 2.0 and 3.1 applications with support for data transmission up to 10 gigabits. Cables are engineered to provide strong shielding protection against EMI to ensure signal integrity and system reliability. In addition to robust electrical characteristics, cables feature tape wrapped jackets for applications requiring lightweight, flexible and laser markable solutions.

USB cables are optimized for a variety of civil and military aerospace data applications:

- In-flight Entertainment
- Mobile Shelters
- High Definition Video
- Ground Vehicles

PIC Wire & Cable's® aircraft cable assembly services for USB cables and connectors will optimize electrical performance and streamline the installation process by simplifying the complex USB cable termination process for technicians in the field.

AEROSPACE USB SOLUTIONS

Physical and Electrical Data

All values nominal unless otherwise noted

Part Number	Data Conductors	Speed	Description	Weight lbs/100 ft (kg/100m)	Bend Radius in (m)	O.D. in (m)	Attenuation dB/1 m max
USB3-2624	26/24 AWG SPCA	USB 3.1	26 AWG Data Wires and 24 AWG Power Wires with flexible tape wrapped, laser markable jacket	3.4 (5.1)	2.00 (50.80)	0.20 (5.08)	625 MHz: 1.07 1.25 GHz: 1.52 2.50 GHz: 2.24 5.00 GHz: 3.38 7.50 GHz: 4.60
USB3-2624-9	26/24 AWG SPCA	USB 3.1	26 AWG Data Wires and 24 AWG Power Wires with ETFE laser markable jacket	3.6 (5.4)	2.00 (50.80)	0.22 (5.59)	625 MHz: 1.07 1.25 GHz: 1.52 2.50 GHz: 2.24 5.00 GHz: 3.38 7.50 GHz: 4.60
USB2624	26/24 AWG SPCA	USB 2.0	26 AWG Data Wires and 24 AWG Power Wires with flexible tape wrapped, laser markable jacket	2.2 (3.3)	0.50 (12.70)	0.16 (4.17)	96 MHz: 10.0 200 MHz: 12.8 400 MHz: 18.2
USB2422	26/24 AWG SPC	USB 2.0	24 AWG Data Wires and 22 AWG Power Wires with ETFE laser markable jacket	2.4 (3.6)	1.00 (25.40)	0.18 (4.57)	96 MHz: 7.2 200 MHz: 10.5 400 MHz: 15.9

Materials Key: SPC – Silver-Plated Copper, SPCA – Silver-Plated Copper Alloy

CABLE CONSTRUCTION

1. PTFE Tape Jacket (White) Laser Markable
2. Silver-Plated Copper Braided Shield
3. Foil Shields
4. Fluoropolymer Insulation
5. Silver-Plated Copper Drain Wire
6. Silver-Plated High Strength Copper Alloy Conductors

COLOR CODES

Twisted Data Pair: White, Green
 Shielded Data Pair #1: Violet, Orange
 Shielded Data Pair #1: Yellow, Blue
 Power Wires: Red, Black

This SuperSpeedPlus (SSP) high speed data cable can be used for high resolution video and also larger, faster storage solutions that require USB 3.1 or 3.0 compliant cables.

USB3-2624 will perform as a USB 3.1 & USB 3.0 cable solution and is backwards compatible for USB 2.0.

This cable is compliant with the Universal Serial Bus Specification 3.1 and can be used for 10 Gbps applications.

USB3-2624 is Skydrol resistant, RoHS compliant and meets the FAA flammability requirements of FAR part 23 and 25.

Contact PIC Wire & Cable for connector availability and to inquire about pre-assembled, tested cable assemblies.

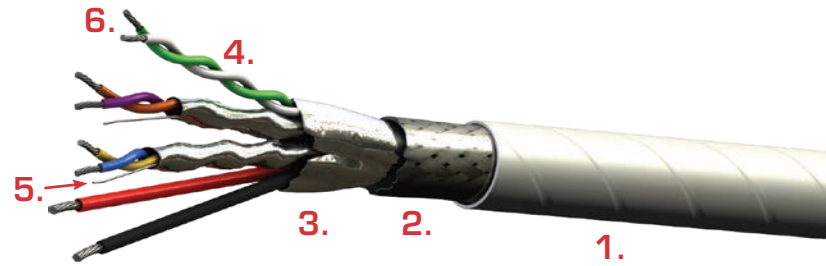

PHYSICAL DATA

- Conductors
 - Data Pairs 26 AWG Stranded SPCA
 - Power Wires 24 AWG Stranded SPCA
 - Drain Wire 28 AWG Stranded SPC
- Shield Coverage 100% (Foil), 80% (Braid)
- Operating Temperature -55° to +200°C
- Outer Diameter: in (mm) 0.20 (5.08)
- Minimum Bend Radius: in (mm) 2.00 (50.80)
- Weight: lbs/100 ft (kg/100 m) 3.4 (5.1)

ELECTRICAL DATA

Data pair (USB 2.0)

- Impedance: ohms 90
- Time Delay: ns/ft (m) 1.46 (4.79)
- Capacitance: pF/ft (m)
 - Cond. to Cond. 16.70 (55.00)
- Attenuation: dB/1 m Max
 - @ 400 MHz 0.75

Data pair (SDP's)

- Impedance: ohms 90
- Time Delay: ns/ft (m) 1.46 (4.79)
- Capacitance: pF/ft (m) 15.24 (50.00)
- Attenuation: dB/1 m Max
 - @ 625 MHz 1.07
 - @ 1.25 GHz 1.52
 - @ 2.50 GHz 2.24
 - @ 5.00 GHz 3.38
 - @ 7.50 GHz 4.60

All values nominal unless otherwise noted

CABLE CONSTRUCTION

1. ETFE Jacket (White) Laser Markable
2. Silver-Plated Copper Braided Shield
3. Foil Shields
4. Fluoropolymer Insulation
5. Silver-Plated Copper Drain Wire
6. Silver-Plated High Strength Copper Alloy Conductors

COLOR CODES

Twisted Data Pair: White, Green
 Shielded Data Pair #1: Violet, Orange
 Shielded Data Pair #1: Yellow, Blue
 Power Wires: Red, Black

This SuperSpeedPlus (SSP) high speed data cable can be used for high resolution video and also larger, faster storage solutions that require USB 3.1 or 3.0 compliant cables.

USB3-2624-9 will perform as a USB 3.1 & USB 3.0 cable solution and is backwards compatible for USB 2.0.

This cable is compliant with the Universal Serial Bus Specification 3.1 and can be used for 10 Gbps applications.

USB3-2624-9 is Skydrol resistant, RoHS compliant and meets the FAA flammability requirements of FAR part 23 and 25.

Contact PIC Wire & Cable for connector availability and to inquire about pre-assembled, tested cable assemblies.

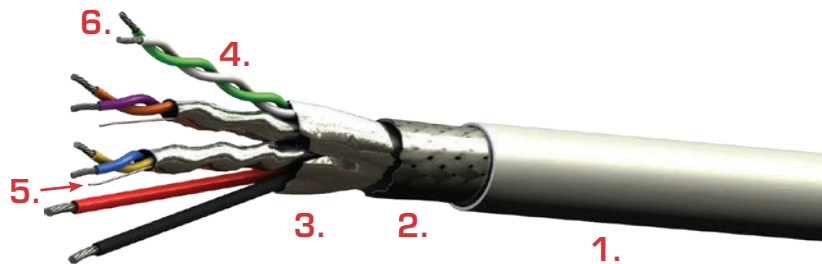

PHYSICAL DATA

- Conductors
 - Data Pairs 26 AWG Stranded SPCA
 - Power Wires 24 AWG Stranded SPCA
 - Drain Wire 28 AWG Stranded SPC
- Shield Coverage 100% (Foil), 80% (Braid)
- Operating Temperature -55° to +200°C
- Outer Diameter: in (mm) 0.22 (5.59)
- Minimum Bend Radius: in (mm) 2.00 (50.80)
- Weight: lbs/100 ft (kg/100 m) 3.6 (5.4)

ELECTRICAL DATA

Data pair (USB 2.0)

- Impedance: ohms 90
- Time Delay: ns/ft (m) 1.46 (4.79)
- Capacitance: pF/ft (m)
 - Cond. to Cond. 16.70 (55.00)
- Attenuation: dB/1 m Max
 - @ 400 MHz 0.75

Data pair (SDP's)

- Impedance: ohms 90
- Time Delay: ns/ft (m) 1.46 (4.79)
- Capacitance: pF/ft (m) 15.24 (50.00)
- Attenuation: dB/1 m Max
 - @ 625 MHz 1.07
 - @ 1.25 GHz 1.52
 - @ 2.50 GHz 2.24
 - @ 5.00 GHz 3.38
 - @ 7.50 GHz 4.60

All values nominal unless otherwise noted

CABLE CONSTRUCTION

1. PTFE Tape Jacket (White) Laser Markable
2. Silver-Plated Copper Braided Shield
3. Foil Shield
4. Silver-Plated Copper Drain Wire
5. PTFE Tape Filler
6. PFA Insulation
7. Silver-Plated High Strength Copper Alloy Conductors

COLOR CODES

Data Pair: White, Green
 Power Wires: Red, Black

This cable has been specially designed by PIC for Airborne USB 2.0 high speed applications. The 100% foil and 80% braided shielding provides for further protection against EMI. This advanced design will allow cable runs up to 18 feet.

USB2624 meets or exceeds all EIA-364-XX specifications. It is Skydrol resistant, RoHS compliant and meets the FAA flammability requirements of FAR Part 23 and 25, Appendix F.

Contact PIC Wire & Cable for connector availability and to inquire about pre-assembled, tested cable assemblies.

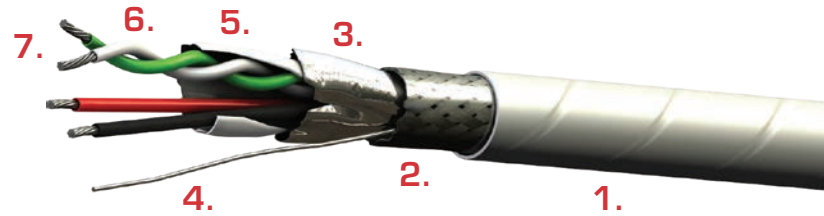

PHYSICAL DATA

- Conductors
 - Data Pair 26 AWG Stranded SPCA
 - Power Wires 24 AWG Stranded SPC
 - Drain Wire 28 AWG Stranded SPC
- Shield Coverage 100% (Foil), 80% (Braid)
- Operating Temperature -55° to +200°C
- Outer Diameter: in (mm) 0.16 (4.17)
- Minimum Bend Radius: in (mm) 0.50 (12.70)
- Weight: lbs/100 ft (kg/100 m) 2.2 (3.3)

ELECTRICAL DATA

Data pair

- Impedance: ohms 90
- Time Delay: ns/ft (m) 1.48 (4.86)
- Capacitance: pF/ft (m)
 - Cond. to Cond. 13.0 (42.7)
 - Cond. to Shield 21.0 (68.9)
- Attenuation: dB/1 m Max
 - @ 96 MHz 10.0
 - @ 200 MHz 12.8
 - @ 400 MHz 18.2

Power wires

- DC Resistance: ohms/1000 ft (m) Max 25.0 (82.0)

All values nominal unless otherwise noted

CABLE CONSTRUCTION

1. ETFE Jacket (White) Laser Markable
2. Tin-Plated Copper Braided Shield
3. Foil Shield
4. Silver-Plated Copper Drain Wire
5. PTFE Tape Filler
6. Extruded Fluoropolymer Insulation
7. Silver-Plated Copper Conductors

COLOR CODES

Data Pair: White, Green
 Power Wires: Red, Black

This cable has been specially designed by PIC for Airborne USB 2.0 high speed applications. The 100% foil and 80% braided shielding provides for further protection against EMI. This advanced design will allow cable runs up to 18 feet.

USB2422 meets or exceeds all EIA-364-XX specifications. It is Skydrol resistant, RoHS compliant and meets the FAA flammability requirements of FAR Part 23 and 25, Appendix F.

Contact PIC Wire & Cable for connector availability and to inquire about pre-assembled, tested cable assemblies.

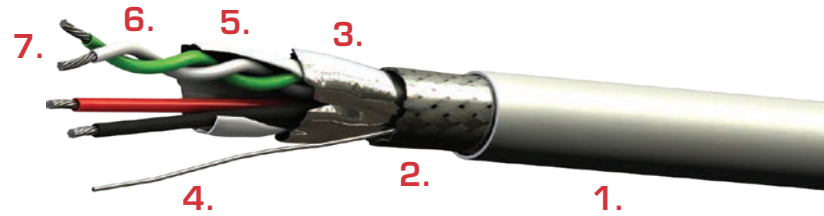

PHYSICAL DATA

- Conductors
 - Data Pair 24 AWG Stranded SPC
 - Power Wires 22 AWG Stranded SPC
 - Drain Wire 28 AWG Stranded SPC
- Shield Coverage 100% (Foil), 80% (Braid)
- Operating Temperature -55° to +150°C
- Outer Diameter: in (mm) 0.18 (4.57)
- Minimum Bend Radius: in (mm) 1.00 (25.40)
- Weight: lbs/100 ft (kg/100 m) 2.4 (3.6)

ELECTRICAL DATA

Data pair

- Impedance: ohms 90
- Time Delay: ns/ft (m) 1.39 (4.56)
- Capacitance: pF/ft (m)
 - Cond. to Cond. 13.0 (42.7)
 - Cond. to Shield 21.0 (68.9)
- Attenuation: dB/1 m Max
 - @ 96 MHz 7.2
 - @ 200 MHz 10.5
 - @ 400 MHz 15.9

Power wires

- DC Resistance: ohms/1000 ft (m) Max 15.2 (49.9)

All values nominal unless otherwise noted

CABLE CONSTRUCTION

1. ETFE Jacket (White) Laser Markable
2. Tin-Plated Copper Braided Shield
3. ETFE Insulation
4. Tin-Plated Copper Conductors

COLOR CODES

White, Blue

This special cable is designed for use in ARINC 429 data bus systems. This cable has been designed with a high temp, laser-markable white ETFE jacket which saves time, eliminating the need to label the cable every 6 inches or so as required by numerous cabling standards.

D620222 is Skydrol resistant, RoHS compliant and passes the FAA flammability requirements of FAR Part 23 and 25, Appendix F. Test results are available upon request.



PHYSICAL DATA

• Conductors	22 AWG Stranded TPC
• Shield Coverage	95% Min.
• Operating Temperature	-55° to +150°C
• Outer Diameter: in (mm)	0.16 (4.06)
• Minimum Bend Radius (in.)	0.80 (20.32)
• Weight: lbs/100 ft (kg/100 m)	2.0 (3.0)

ELECTRICAL DATA

• Impedance: ohms	70
• Capacitance: pF/ft (m)	24.0 (78.7)
• Velocity of Propagation: %	70.0
• Dielectric Voltage Rating (kV RMS)	1.5
• DC Resistance: ohms/1000 ft (m) Max	15.8 (51.8)
• Attenuation: dB/100 ft (m) @ 1 MHz Max	1.2 (3.9)

All values nominal unless otherwise noted

CABLE CONSTRUCTION

1. ETFE Jacket (Clear)
2. Tin-Plated Copper Braided Shield
3. ETFE Insulation
4. Tin-Plated Copper Conductors

COLOR CODES

White, Blue

This special cable is designed for use in ARINC 429 data bus systems, in addition to other approved applications listed below:

Honeywell has approved D620224 for handling high-speed digital information, including:

- UDI port inputs/outputs between DATA NAV processors, Lightning Sensor System processors and PRIMUS weather radar indicators.
- Picture bus signals between PRIMUS weather radar receiver/transmitters and EFIS symbol generators. (Honeywell EPIC/APEX Integrated Avionics Systems)

AlliedSignal approved PIC cable D620224 for video and deflection cabling between the symbol generators and display units for the EFS 40/50.

D620224 is Skydrol resistant, RoHS compliant and passes the FAA flammability requirements of FAR Part 23 and 25, Appendix F. Test results are available upon request.



PHYSICAL DATA

• Conductors	24 AWG Stranded TPC
• Shield Coverage	95% Min.
• Operating Temperature	-55° to +150°C
• Outer Diameter: in (mm)	0.14 (3.45)
• Minimum Bend Radius (in.)	0.68 (17.27)
• Weight: lbs/100 ft (kg/100 m)	1.7 (2.5)

ELECTRICAL DATA

• Impedance: ohms	70
• Capacitance: pF/ft (m)	30.0 (98.4)
• Velocity of Propagation: %	70.0
• Dielectric Voltage Rating (kV RMS)	1.5
• DC Resistance: ohms/1000 ft (m) Max	26.2 (86.0)
• Attenuation: dB/100 ft (m) @ 1 MHz Max	1.4 (4.6)

All values nominal unless otherwise noted

*Honeywell P/N 3718911-11
 Bendix/King P/N 025-05114-0000*

CABLE CONSTRUCTION

1. Fluoropolymer Inner & Outer Jackets (Translucent White)
2. Silver-Plated Copper Braided Shields
3. Fluoropolymer Insulation
4. PTFE Fillers
5. Silver-Plated Copper Conductors

COLOR CODES

Clear, Blue

This is the approved Quadrax Cable for Honeywell Series 81, 82, 84, and 86 Radars, used as the ARINC bus connection from the radar sensor to radar display and symbol generators, and to interface with EFIS 10 and EFS 40 and 50 systems.

Because D5102QX employs isolated shields, it is ideal for use in radar and other applications where susceptibility to noise is of concern and EMI suppression is required.

Conductor insulation and the inner and outer jackets are fluoropolymer Teflon®. Fillers are provided to aid in controlling uniform impedance. The double shields are silver-plated copper with 95% minimum coverage.

D5102QX is Skydrol resistant and meets the specifications of MIL-C-27500, is RoHS compliant and passes the FAA flammability requirements of FAR Part 23 and 25, Appendix F. Test results are available upon request.

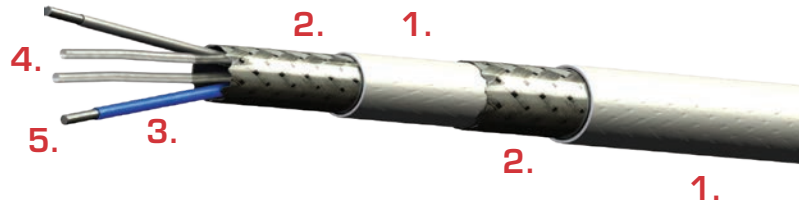

PHYSICAL DATA

- Conductor 22 AWG Stranded SPC
- Operating Temperature -55° to +200°C
- Outer Diameter: in (mm) 0.23 (5.84)
- Minimum Bend Radius (in.) 1.15 (29.21)
- Weight: lbs/100 ft (kg/100 m) 5.8 (8.6)

ELECTRICAL DATA

- Impedance: ohms 78
- Capacitance: pF/ft (m) 18.6 (61.0)
- Velocity of Propagation: % 70.0
- Dielectric Voltage Rating (kV RMS) 1.5
- DC Resistance: ohms/1000 ft (m) Max 15.2 (49.9)
- Attenuation: dB/100 ft (m) @ 10 MHz Max 3.0 (9.8)

All values nominal unless otherwise noted

*Bendix P/N 44152-0002
King P/N 024-00064-0000 Rev. 3*

CABLE CONSTRUCTION

1. ETFE Jacket (White) Laser Markable
2. Silver-Plated Copper High Strength Copper Alloy Shield
3. PTFE Insulation
4. Fluoropolymer Fillers
5. Silver-Plated High-Strength Copper Alloy Conductors

COLOR CODES

White, Blue

PIC's G771553 is a laser markable version of Military Standard 1553B data bus cable that saves weight and time versus using traditional 1553B cable and labels. Most 1553 data bus applications require identification at regular intervals (e.g. every 2 feet); using traditional 1553B cable and labels requires an investment in label material and installation labor while adding significant weight to the final cable. In addition, G771553 is 5% lighter weight than most standard 1553B cables, saving 1 lb. for every 1000 feet of cable used.

G771553 is a 77 ohm twinaxial cable constructed of high quality materials that meet or exceed the requirements for 1553B data bus cable. It is Skydrol resistant, RoHS compliant and meets the FAA flammability requirements of FAR Part 23 and 25, Appendix F; complies with MIL-C-17 as applicable.

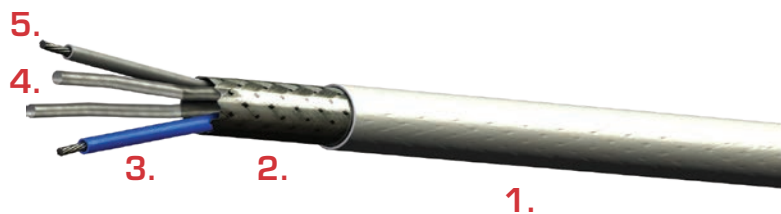

PHYSICAL DATA

- Conductor 24 AWG Stranded SPCA
- Shield Coverage 90% Min.
- Operating Temperature -55° to +200°C
- Outer Diameter: in (mm) 0.125 (3.175)
- Minimum Bend Radius: in (mm) 0.65 (16.51)
- Weight: lbs/100 ft (kg/100 m) 1.7 (2.5)

ELECTRICAL DATA

- Impedance: ohms 77
- Capacitance: pF/ft (m) 23.4 (76.8)
- Velocity of Propagation: % 68.0
- Dielectric Voltage Rating (kV RMS) 1.5
- DC Resistance: ohms/1000 ft (m) Max 28.4 (93.2)
- Attenuation: dB/100 ft (m) @ 1 MHz Max 1.4 (4.6)

All values nominal unless otherwise noted

M17/176

CABLE CONSTRUCTION

1. Fluoropolymer Jacket (White)
Laser Markable
2. Silver-Plated Copper Braided Shield
3. Fluoropolymer Binder
4. Fluoropolymer Fillers
5. Foamed Fluoropolymer Insulation
6. Silver-Plated High Strength
Copper Alloy Conductors



COLOR CODES

Blue, White

A Controller Area Network (CAN Bus) is a robust vehicle bus standard designed to allow micro-controllers and devices to communicate with each other in applications without a host computer. D10226-0 is a 120 Ohm controlled impedance cable designed to meet the high electrical demand of a CAN Bus cabling system.

D10226-0 incorporates design features that provide maximum electrical performance with high strength copper alloy conductors and silver plated copper shields. A foamed Fluoropolymer wire insulation is used to reduce signal loss and weight for longer lengths. Its laser markable jacket passes EN3475-503 scrape abrasion testing and is also flexible for ease of installation.

The D10226-0 cable materials are rugged and high temperature (+200°C) that pass the immersion (fluid) test for MIL-DTL-17H, Section 3.7.26 and EN3475-411. It is RoHS compliant, passes the FAA flammability requirements of FAR Part 23 and 25, and passes the Airbus and Boeing toxicity requirements.

PHYSICAL DATA

- Conductors 26 AWG (19/38) Stranded SPCA
- Shield Coverage 95% (Braid)
- Operating Temperature -55° to +200°C
- Outer Diameter: in (mm) 0.13 (3.30)
- Minimum Bend Radius: in (mm) 0.70 (17.78)
- Weight: lbs/100 ft (kg/100 m) 1.5 (2.2)

ELECTRICAL DATA

- Impedance: ohms 120
- Capacitance: pF/ft (m) 13.7 (44.9)
- Velocity of Propagation: % 80.0
- Dielectric Voltage Rating (kV RMS) 0.9
- DC Resistance: ohms/1000 ft (m) Max 44.8 (147.0)
- Attenuation: dB/100 ft (m) @ 1 MHz Max 0.9 (3.0)

All values nominal unless otherwise noted

CABLE CONSTRUCTION

1. ETFE Jacket (White) Laser Markable
2. Tin-Plated Copper Braided Shield
3. Foil Shield
4. Foam Fluoropolymer Outer Insulation
5. Solid PFA Inner Insulation
6. Silver-Plated High Strength Copper Alloy Conductors

COLOR CODES

White, Blue

This cable is a 125 ohm data bus cable approved and recommended by the Honeywell Commercial Flight Systems Group. It is an approved cable for the ASCB Data bus and Servo CAN Bus for the Primus EPIC/APEX Integrated Avionics system.

T12243 is a primary data interface for the Honeywell/Sperry SPZ-8000 DAFCS which includes EFIS, AHRS and DADC. It is also used for CAN Bus communications for the Honeywell/Sperry Primus II Radio System.

This cable is designed to simplify the termination process, pin extraction and to improve the overall quality of the installation.

Designing a cable of specified impedance requires that conductor insulation be extruded to a defined thickness, which is related to dielectric characteristics of the insulation material. For this type of 125 ohm cable, the diameter of the insulation is typically 1-1/2 times the diameter of the contact crimped to the wire. This large insulation diameter interferes with extraction procedures.

To solve this problem, PIC has employed a dual-layer insulation — an outer foamed fluoropolymer layer which can be removed so that the inner solid PFA accommodates the connector cavity for easy extraction of the contact.

T12243 cable is Skydrol resistant, RoHS compliant and passes the FAA flammability requirements of FAR Part 23 and 25, Appendix F. Test results are available upon request.



PHYSICAL DATA

- Conductors 24 AWG Stranded SPCA
- Dual Layer Insulation
 - Inner Layer OD: in (mm) 0.044 (1.118)
 - Outer Layer OD: in (mm) 0.075 (1.905)
- Shield Coverage 100% (Foil), 90% (Braid)
- Operating Temperature -55° to +150°C
- Outer Diameter: in (mm) 0.20 (4.95)
- Minimum Bend Radius (in.) 1.00 (25.40)
- Weight: lbs/100 ft (kg/100 m) 2.5 (3.7)

ELECTRICAL DATA

- Impedance: ohms 125
- Capacitance: pF/ft (m) 11.0 (36.1)
- Velocity of Propagation: % 75.0
- Dielectric Voltage Rating (kV RMS) 1.5
- DC Resistance: ohms/1000 ft (m) Max 27.5 (90.2)
- Attenuation: dB/100 ft (m) Max
 - @ 10 MHz 2.0 (6.6)
 - @ 100 MHz 6.3 (20.0)

All values nominal unless otherwise noted

**Time Trigger Protocol
Avionic Standard Communication Bus
Controller Area Network Bus*

Honeywell P/N 025-05125-0001

CABLE CONSTRUCTION

1. Extruded Fluoropolymer Jacket (White)
2. Tin-Plated Copper Braided Shield
3. Extruded PTFE Insulation
4. Silver-Plated High Strength Copper Alloy Conductors

COLOR CODES

White, Brown

This cable is a 125 ohm data bus cable approved and recommended by the Honeywell Commercial Flight Systems Group. It is an approved cable for the ASCB Data bus and Servo CAN Bus for the Primus EPIC/APEX Integrated Avionics system.

T69654 is a primary data interface for the Honeywell/Sperry SPZ-8000 DAFCS which includes EFIS, AHRS and DADC. It is also used for CAN Bus communication for the Honeywell/Sperry Primus II Radio System.

T69654 is Skydrol resistant, RoHS compliant and passes the FAA flammability requirements of FAR Part 23 and 25, Appendix F. Test results are available upon request.



PHYSICAL DATA

- Conductors 24 AWG Stranded SPCA
- Shield Coverage 90% (Braid)
- Operating Temperature -50° to +150°C
- Outer Diameter: in (mm) 0.19 (4.83)
- Minimum Bend Radius (in.) 1.00 (25.40)
- Weight: lbs/100 ft (kg/100 m) 2.2 (3.3)

ELECTRICAL DATA

- Impedance: ohms 125
- Capacitance: pF/ft (m) 12.0 (39.4)
- Velocity of Propagation: % 70.0
- Dielectric Voltage Rating (kV RMS) 1.5
- DC Resistance: ohms/1000 ft (m) Max 28.4 (93.2)

All values nominal unless otherwise noted

**Time Trigger Protocol
Avionic Standard Communication Bus
Controller Area Network Bus*

CABLE CONSTRUCTION

1. Extruded Fluoropolymer Jacket (Translucent Blue)
2. Tin-Plated Copper Braided Shield
3. Foil Shield
4. Foamed Fluoropolymer Insulation
5. Fluoropolymer Filler
6. Silver-Plated High Strength Copper Alloy Conductors

COLOR CODES

Pair #1 - Red, Black
 Pair #2 - Blue, Green

This cable has been specially designed by PIC for airborne high-speed data applications. It is an approved cable by Honeywell for the EPIC/APEX System.

Data transmission aboard aircraft faces more severe environmental and EMI situations than conventional LAN systems in commercial buildings, hence special measures have been taken to preserve technical performance.

Each conductor is surrounded by a foam fluoropolymer insulation and is designed to be terminated in ARINC 600 and 38999 quadrax contacts.

A fluoropolymer jacket protects the cable against abrasion and environmental effects while maintaining flexibility for ease of installation.

F20424 is Skydrol resistant, RoHS compliant and passes the FAA flammability requirements of FAR Part 23 and 25, Appendix F. Test results are available upon request.

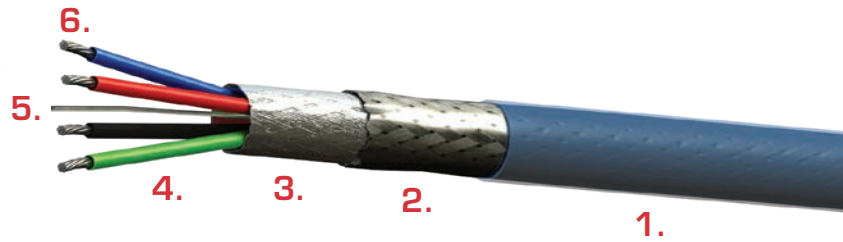

PHYSICAL DATA

- Conductors 24 AWG Stranded SPCA
- Shield Coverage 90% Min.
- Operating Temperature -55° to +150°C
- Outer Diameter: in (mm) 0.24 (6.15)
- Minimum Bend Radius: in (mm) 1.20 (30.48)
- Weight: lbs/100 ft (kg/100 m) 3.7 (5.4)

ELECTRICAL DATA

- Impedance: ohms 150
- Capacitance: pF/ft (m) 8.5 (24.9)
- Velocity of Propagation: % 80.0
- Dielectric Voltage Rating: KV RMS 0.9
- DC Resistance: ohms/1000 ft (m) Max 26.2 (86.0)
- Attenuation: dB/100 ft (m)
 - @ 10 MHz 1.6 (5.2)
 - @ 100 MHz 5.2 (17.1)
 - @ 500 MHz 11.5 (37.7)

All values nominal unless otherwise noted

CABLE CONSTRUCTION

1. Fluoropolymer Jacket (Clear)
2. Tin-Plated Copper Braided Shield
3. ETFE Insulations & Jackets
4. Tin-Plated Copper Conductors

COLOR CODES

- Pair #1: White Jacket, White, Light Blue
 Pair #2: Black Jacket, White, Light Blue
 Pair #3: Red Jacket, White, Light Blue
 Pair #4: Blue Jacket, White, Light Blue
 Triad: Green Jacket, White, White/Blue, White/Orange

This eleven conductor cable (4 pairs, 1 triad) is approved and recommended by the Sperry Commercial Flight Systems Division of Honeywell, Inc. for their LSZ 850 system. It is for interconnecting the antenna (AT 850) to the processor (LP 850); then to the controller (LU 850). It is approved by Honeywell for the APEX/EPIC system.

D611122 cable is Skydrol resistant, RoHS compliant and passes the FAA flammability requirements of FAR Part 23 and 25, Appendix F. Test results are available upon request.

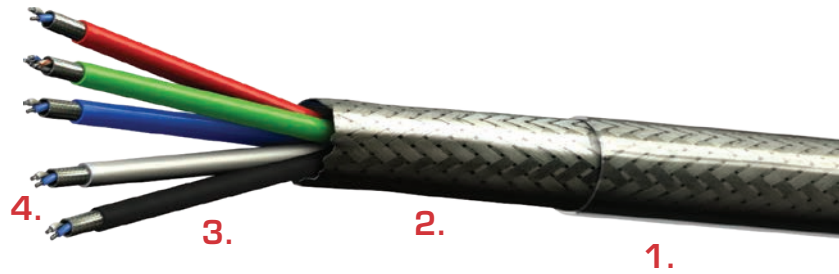

PHYSICAL DATA

- | | |
|---------------------------------|---------------------|
| • Conductors | 22 AWG x 19 strands |
| • Insulation & Inner Jackets | ETFE |
| • Shields | 95% Min. |
| • Outer Jacket | Fluoropolymer |
| • Operating Temperature | -55° to +150°C |
| • Outer Diameter: in (mm) | 0.45 (11.43) |
| • Minimum Bend Radius (in.) | 4.50 (114.30) |
| • Weight: lbs/100 ft (kg/100 m) | 14.5 (21.6) |

ELECTRICAL DATA

- | | |
|--------------------------|-----|
| • Impedance: ohms* | 70 |
| • Voltage Rating (volts) | 600 |

**per MIL-C-915 (pairs only)*

All values nominal unless otherwise noted

**APPROVED CABLES FOR STORMSCOPE™ SERIES II
AND L-3 COMMUNICATIONS TCAS I, TAS SYSTEMS**

These cables are approved by L-3 Communications Flight Systems for installing Models WX-1000+ Stormscope Weather Mapping Systems and Models CWS 691, TCAS 791 and Skywatch 497/899 Collision Warning / Collision Avoidance Systems.

All cables have multiple shields of tinned copper braid with 95% minimum coverage. They are Skydrol resistant, RoHS compliant and meet the FAA flammability requirements of FAR Part 23 and 25, Appendix F; comply with MIL-C-27500 as applicable.

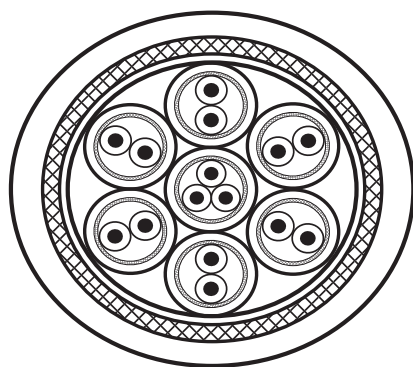

WM25815

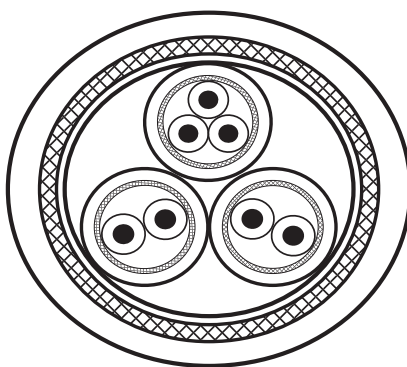

WM25807

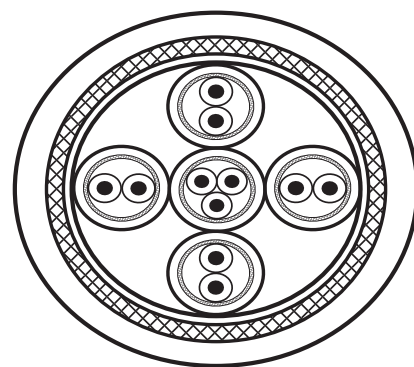

WM25811

SPECIFIC CABLE CONFIGURATIONS

PIC P/N	Wire AWG Pairs	Wire AWG Triad	No. Of Conductors	Jacket (Fluoropolymer)	OD (In.)	Weight (lbs./100ft.)
WM 25815	24	22	15	Red	.400	14.5
WM 25807	24	24	7	Clear	.280	8.5
WM 25811	24	22	11	Blue	.350	11.3

All values nominal unless otherwise noted



To provide high bandwidth for data and support satellite communications, PIC Wire & Cable® is once again advancing the market. Like all our 50 ohm RF cables, our high frequency cables feature minimum 200°C on all materials. With over 45 years of design and manufacturing expertise our high frequency cables reduce weight, decrease loss and improve EMI performance.

Designed specifically to serve Ku Band & X Band applications, our MicroMATES® cables feature: inner flat braid or strip braid, high temp polyimide foil, dual braided shields and silver-plated copper throughout—everything to make your job easier and your platform more productive.

Custom Cable Assemblies

Proper cable assembly is critical to realizing the full benefits of the cable and connector technology. Our special tooling and specialized technicians ensure your job is done to precision. Maximize the performance of your microwave cables with:

- Certified Test Process & Equipment
- Phase-matched Ship Sets
- Qualified Assembly Experts
- ISO 9001; AS 9100 Certification
- Complete Lot Traceability
- Improved Supply Chain Efficiency

HIGH FREQUENCY SOLUTIONS

Physical and Electrical Data

All values nominal unless otherwise noted

Coaxial Cable	Cable O.D. in (mm)	Weight lbs/100 ft (kg/100 m)	Temperature Range (°C)	Shielding Effectiveness (dB)	VOP	Loss @ 1 GHz dB/100 ft (dB/100 m)	Loss @ 12 GHz dB/100 ft (dB/100 m)	Loss @ 18 GHz dB/100 ft (dB/100 m)
HT77300F	0.30 (7.62)	8.8 (13.1)	-55/+200	-90	77.0%	5.0 (16.4)	19.5 (64.0)	24.7 (81.0)
HT77210F	0.21 (5.28)	4.5 (6.7)	-55/+200	-90	76.5%	7.6 (24.9)	29.5 (96.8)	37.3 (122.4)
HH85295F	0.29 (7.37)	7.9 (11.8)	-55/+200	-110	83.0%	3.8 (12.5)	15.4 (50.5)	19.7 (64.6)

2 WEEK LEAD TIME OR LESS ON MANY ASSEMBLIES

Call 800.742.3191 Regarding MicroMATES Availability

See Back for Connector and Physical & Electrical Data

Attribute Overview

Coaxial Cable	Max Freq	Size	EMI Resist	Loss	Weight	Flex Life
HT77300F	18GHz	Small	High	Low	Light	Very High
HT77210F	26GHz	Very Small	High	Low	Light	Very High
HH85295F	18GHz	Small	Very High	Very Low	Light	High

Connector Data

HT77300F	HT77210F	HH85295F	CONNECTOR TYPE
120208	120508	120608	TNC Straight Plug
120209	120509	120609	TNC 90 Degree Plug
120221	120521	120621	TNC Bulkhead Jack
120210	120510	120610	N Straight Plug
120211	120511	120611	N 90 Degree Plug
120222	N/A	120622	N Bulkhead Jack
120214	120514	120614	SMA Straight Plug
120215	120515	120615	SMA 90 Degree Plug
N/A	120534	N/A	BMB Jack Snap Mount
N/A	120535	N/A	BMB SZ 5 Jack

Call PIC For Other Connector Availability

Electromagnetic Spectrum

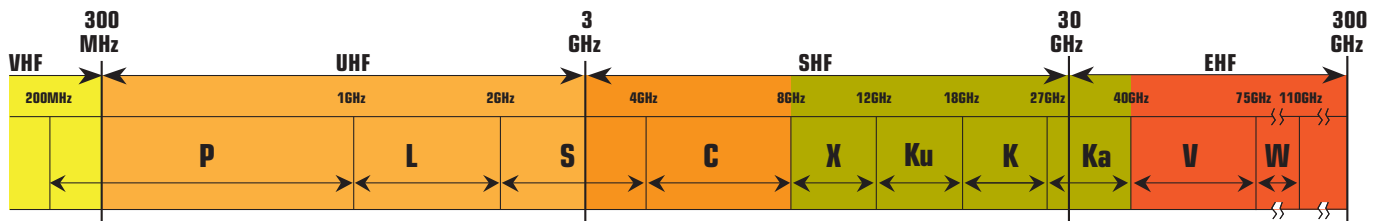

PIC  **MicroMATES[®]**
SPECTRUM

CABLE CONSTRUCTION

1. Fluoropolymer Jacket (Olive Drab)
2. Round Silver-Plated Copper
3. Aluminum Polyimide
4. Silver-Plated Copper Flat Strip Braid
5. PTFE Dielectric
6. Solid Silver-Plated Copper

Designed specifically to serve High Frequency Applications on the Ku band & X band, this new Microwave Cable features minimum 200°C on all materials, Silver-Plated Copper throughout, plus: Inner Flat Strip Braid; High Temp Polyimide Foil; and Braided Shield.

Special tooling and specialized technicians ensure your custom cable assembly is done to precision—maximizing the performance of the PIC HT77300F with: Certified Test Process & Equipment-- ISO 9001/AS 9100; Phase-matched Ship Sets; Complete Lot Traceability; Certified Test Reports; and Improved Supply Chain Efficiency. [For quality assurance this cable is sold in an assembly only].

CONNECTOR DATA

PIC P/N	CONNECTOR TYPE
120208	TNC Straight Plug
120209	TNC 90 Degree Plug
120221	TNC Bulkhead Jack
120210	N Straight Plug
120211	N 90 Degree Plug
120222	N Bulkhead Jack
120214	SMA Straight Plug
120215	SMA 90 Degree Plug

Call PIC For Other Connector Availability

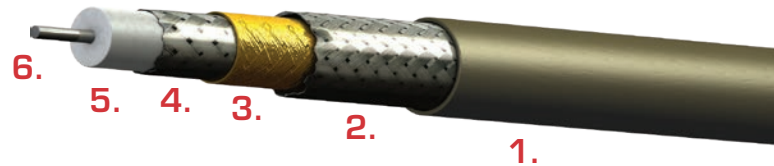

PHYSICAL DATA

- Conductor 12 AWG Solid Silver-Plated Copper
- Operating Temperature -55° to +200°C
- Outer Diameter: in (mm) 0.30 (7.62)
- Minimum Bend Radius: in (mm) 1.5 (38.1)
- Weight: lbs/100 ft (kg/100 m) 8.8 (13.1)
- Complies with RoHS (Directive 2002/95/EC)
- Complies with FAR Part 23 and 25, Appendix F

ELECTRICAL DATA

- Impedance: ohms 50
- Capacitance: pF/ft (m) 26.5 (87.0)
- Velocity of Propagation: % 77.0
- RF Shielding Effectiveness: dB/min -90
- Attenuation: Nom / Max dB/100 ft (dB/100 m)
 - @1 GHz 5.0 / 5.5 (16.4 / 18.0)
 - @3 GHz 9.0 / 9.9 (29.5 / 32.5)
 - @6 GHz 13.2 / 14.5 (43.3 / 47.6)
 - @12 GHz 19.5 / 21.5 (64.0 / 70.5)
 - @18 GHz 24.7 / 27.2 (81.0 / 89.2)
- K Values (nom loss): K1 = 0.15, K2 = 0.000255
- Formula for Attenuation: $(K1 * \sqrt{F(MHz)} + (K2 * F(MHz)))$

All values nominal unless otherwise noted

2 WEEK LEAD TIME OR LESS ON MOST ASSEMBLIES

CABLE CONSTRUCTION

1. Fluoropolymer Jacket (Olive Drab)
2. Round Silver-Plated Copper
3. Aluminum Polyimide
4. Silver-Plated Copper Flat Strip Braid
5. PTFE Dielectric
6. Solid Silver-Plated Copper

Designed specifically to serve High Frequency Applications on the Ku band & X band, this new Microwave Cable features minimum 200°C on all materials, Silver-Plated Copper throughout, plus: Inner Flat Strip Braid; High Temp Polyimide Foil; and Braided Shield.

Special tooling and specialized technicians ensure your custom cable assembly is done to precision—maximizing the performance of the PIC HT77210F with: Certified Test Process & Equipment-- ISO 9001/AS 9100; Phase-matched Ship Sets; Complete Lot Traceability; Certified Test Reports; and Improved Supply Chain Efficiency. [For quality assurance this cable is sold in an assembly only].

CONNECTOR DATA

PIC P/N	CONNECTOR TYPE
120508	TNC Straight Plug
120509	TNC 90 Degree Plug
120521	TNC Bulkhead Jack
120510	N Straight Plug
120511	N 90 Degree Plug
120514	SMA Straight Plug
120515	SMA 90 Degree Plug
120534	BMB Jack Snap Mount
120535	BMB SZ 5 Jack

Call PIC For Other Connector Availability

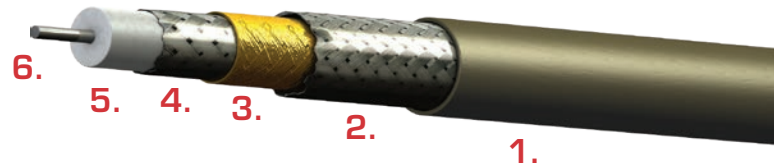

PHYSICAL DATA

- Conductor 16 AWG Solid Silver-Plated Copper
- Operating Temperature -55° to +200°C
- Outer Diameter: in (mm) 0.21 (5.28)
- Minimum Bend Radius: in (mm) 1.0 (25.4)
- Weight: lbs/100 ft (kg/100 m) 4.5 (6.7)
- Complies with RoHS (Directive 2002/95/EC)
- Complies with FAR Part 23 and 25, Appendix F

ELECTRICAL DATA

- Impedance: ohms 50
- Capacitance: pF/ft (m) 26.5 (87.0)
- Velocity of Propagation: % 76.5
- RF Shielding Effectiveness: dB/min -90
- Attenuation: Nom / Max dB/100 ft (dB/100 m)
 - @1 GHz 7.6 / 8.4 (24.9 / 27.6)
 - @3 GHz 13.7 / 15.1 (44.9 / 49.5)
 - @6 GHz 20.0 / 22.0 (65.6 / 72.2)
 - @12 GHz 29.5 / 32.5 (96.8 / 106.6)
 - @18 GHz 37.3 / 40.1 (122.4 / 131.6)
 - @26 GHz 46.2 / 50.9 (151.6 / 167.0)
- K Values (nom loss): K1 = 0.232, K2 = 0.00034
- Formula for Attenuation: $(K1 * \sqrt{F(MHz)}) + (K2 * F(MHz))$

All values nominal unless otherwise noted

2 WEEK LEAD TIME OR LESS ON MOST ASSEMBLIES

CABLE CONSTRUCTION

1. Fluoropolymer Jacket (Olive Drab)
2. Round Silver-Plated Copper
3. Silver-Plated Copper Spiral Shield
4. PTFE Dielectric
5. Solid Silver-Plated Copper

Designed specifically to serve High Frequency Applications on the Ku band & X band, this new Microwave Cable features minimum 200°C on all materials, Silver-Plated Copper throughout. HH85295F is 100% shielded construction, incorporating a flat spiral wrapped shield which achieves -110 dB shielding effectiveness, same as a solid copper tube. The inner spiral shield conforms to the low-loss PTFE dielectric for superior uniformity and stability of all operation parameters, initially and over time.

Special tooling and specialized technicians ensure your custom cable assembly is done to precision—maximizing the performance of the PIC HH85295F with: Certified Test Process & Equipment-- ISO 9001/AS 9100; Phase-matched Ship Sets; Complete Lot Traceability; Certified Test Reports; and Improved Supply Chain Efficiency. [For quality assurance this cable is sold in an assembly only].

CONNECTOR DATA

PIC P/N	CONNECTOR TYPE
120608	TNC Straight Plug
120609	TNC 90 Degree Plug
120621	TNC Bulkhead Jack
120610	N Straight Plug
120611	N 90 Degree Plug
120622	N Bulkhead Jack
120614	SMA Straight Plug
120615	SMA 90 Degree Plug

Call PIC For Other Connector Availability

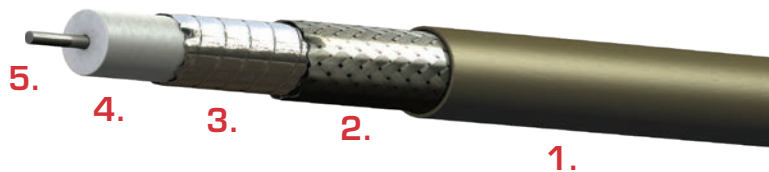

PHYSICAL DATA

- Conductor 11 AWG Solid Silver-Plated Copper
- Operating Temperature -55° to +200°C
- Outer Diameter: in (mm) 0.29 (7.37)
- Minimum Bend Radius: in (mm) 1.5 (38.1)
- Weight: lbs/100 ft (kg/100 m) 7.9 (11.8)
- Complies with RoHS (Directive 2002/95/EC)
- Complies with FAR Part 23 and 25, Appendix F

ELECTRICAL DATA

- Impedance: ohms 50
- Capacitance: pF/ft (m) 24.0 (78.8)
- Velocity of Propagation: % 83.0
- RF Shielding Effectiveness: dB/min -110
- Attenuation: Nom / Max dB/100 ft (dB/100 m)
 - @12 GHz 15.4 / 17.0 (50.5 / 55.8)
 - @15 GHz 17.7 / 19.5 (58.1 / 64.0)
 - @18 GHz 19.7 / 21.8 (64.6 / 71.5)
- K Values (max loss): K1 = 3.86, K2 = 0.30
- Formula for Attenuation: $(K1 * \sqrt{F(GHz)}) + (K2 * F(GHz))$

All values nominal unless otherwise noted

CALL 800.742.3191 REGARDING CABLE AVAILABILITY

PIC MATES®

INTERCONNECT PRODUCTS



RF



Video



Data



Micro

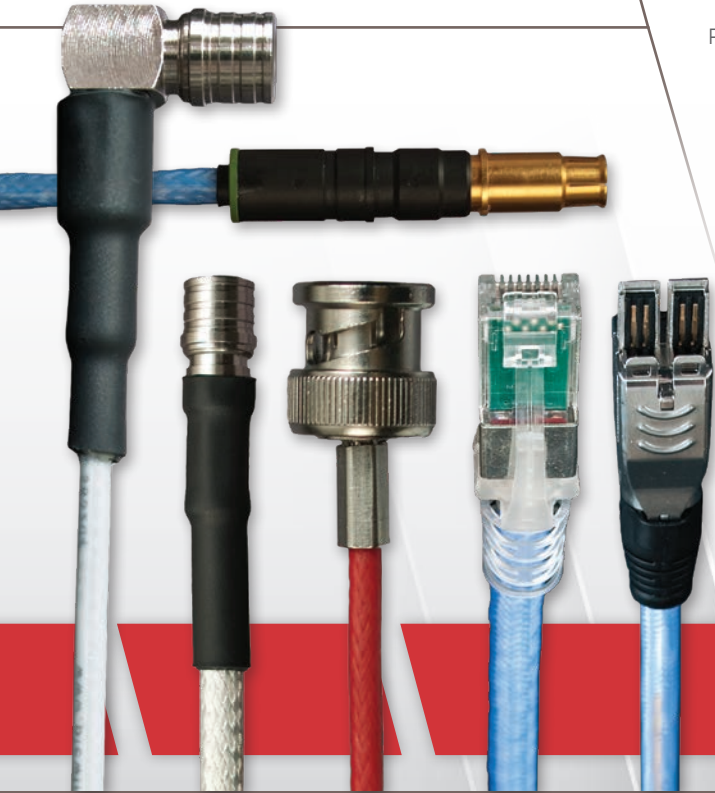

PIC Wire & Cable® has an extensive line of high quality connectors and contacts for its cable offering, including TNC, BNC, N, HN, C, SMA, ARINC, M39029 and D-Sub. In addition, PIC has many innovative connectors that improve termination, installation, maintenance and reliability. To ensure proper field installation, termination instructions and crimp die sets are available for most connectors. PIC also offers complete certified cable assemblies built to your requirements.

For over 45 years, PIC Wire & Cable has been a global provider of electronic cables, cable connectors, and cable assemblies for demanding military, corporate and commercial applications that include airplanes, helicopters, ground vehicles, rail transport and marine vessels. PIC cables, connectors and cable assemblies are widely specified for use in major aerospace and military systems throughout the world.

Connectors for:

- 50 Ohm RF Coaxial & Triaxial Cable
- 75 Ohm Video Coaxial & Triaxial Cable
- High Speed Data Communications Cable

CONNECTOR SOLUTIONS

UNIQUE PRODUCT FEATURES



75 Degree TNC Plug

When a 90 Degree connector creates interference and a straight connector consumes too much space, PIC's innovative 75 Degree plug is the space saving and easy maintenance answer.

QUAD Connector

Four hermetically-sealed connections through one circular hole in the bulkhead. Available in TNC and BNC 50 ohm and 75 ohm types. TCAS/Mode S installations can use three panel holes instead of as many as twelve—saving space, time and money.



Size 16 Contact with Built in Extraction Sleeve

Designed for 75 ohm video applications, PIC's Size 16 contacts save space and include a built-in extraction mechanism for easier removal from rack or circular connectors. These contacts are compatible with PIC's V75268, V76261 and V73263 video cables that are stronger, lower loss and easier to terminate than RG179.



BladePatch RJ45 Connector

The BladePatch connector features a unique, innovative design to lock into a standard RJ45 jack. Simply push the connector into the jack to lock; pull back on the connector body to release. This design provides a secure connection and eliminates the standard RJ45 locking tabs that break easily and can be difficult to access.



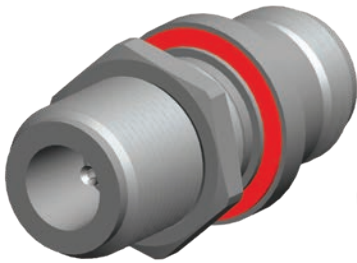

110185



110195

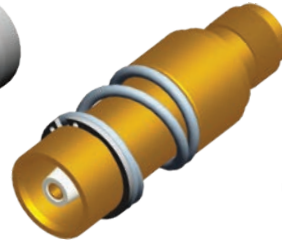

190003



190005

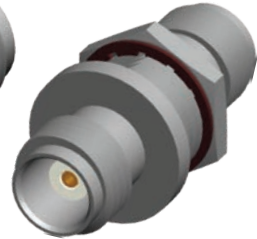

190011

PIC WIRE & CABLE HAS AN EXTENSIVE LINE OF HIGH QUALITY 50 OHM RF ADAPTERS. LET US KNOW WHAT KIND OF ADAPTER YOU NEED TO MEET YOUR NEEDS!

Description	P/N	Features
BNC Jack to Jack	110195	Hermetic
“N” Type Jack to Jack	110185	Non-Hermetic
TNC Jack to Jack	190005	Hermetic
TNC Jack to Jack	190011	Hermetic, Stainless Steel
TNC Jack to Jack	190012	Hermetic, Safety Wire Holes
TNC Jack to ARINC 404 Size 1 Socket	190003	Standard Body
TNC Jack to ARINC 600 Size 1 Socket	190008	Standard Body
TNC Jack to ARINC 600 Size 1 Socket	190009	Extended Body

190052, 190054, & 190056 QUAD CONNECTOR

PRODUCT BULLETIN

TIME, SPACE & MONEY SAVER

Four hermetically-sealed connections through one circular hole in the bulkhead. Available in TNC and BNC 50 Ohm, and BNC 75 Ohm types. TCAS/Mode S installations can use three panel holes instead of as many as twelve.



Installed QUAD Connector



PIC has over 45 years of success in aircraft programs worldwide; let us help you find the best electronic cabling solution for your application.

Description	P/N	Characteristics
TNC, 4 Jacks (50 ohm)	190052	<ul style="list-style-type: none"> • (US Patent 6,835,093) RoHS Compliant • Frequency Range: 0-12GHZ • Voltage Rating: 500 VRMS • Insertion loss: .10 @ 1030 MHZ • Size: MIL-C-26482, Series 2, Size 24 Shell • Weight: 4.58 Ounces • Body & Finish Stainless/Passivated
BNC, 4 Jacks (75 ohm)	190054	
BNC, 4 Jacks (50 ohm)	190056	
TNC, 4 Jacks (75 ohm)	190060	

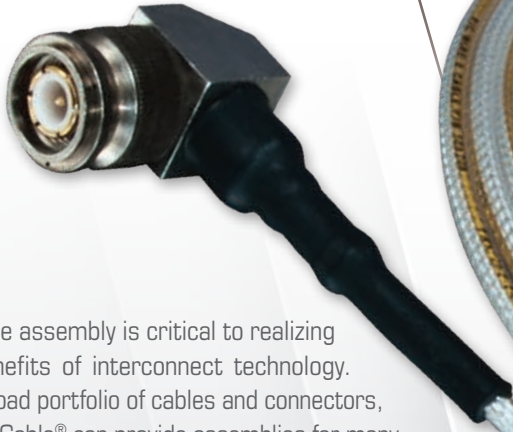

Proper cable assembly is critical to realizing the full benefits of interconnect technology. From its broad portfolio of cables and connectors, PIC Wire & Cable® can provide assemblies for many applications including avionics systems, video and high-speed data.

- ISO 9001 : AS9100 Certifications
- Certified Test Processes & Equipment
- Built and Tested to Customer Requirements
- Qualified Assembly Experts
- Test Reports Included with Every Assembly
- Precision Phase-Matched Shipped Sets
- Complete Lot Traceability
- Improved Supply Chain Efficiency

CABLE ASSEMBLY SOLUTIONS

TRUST YOUR CABLE ASSEMBLIES TO PIC WIRE & CABLE

For over 45 years, PIC Wire & Cable has been a global provider of electronic cables, cable connectors and cable assemblies for demanding military, corporate and commercial applications that include airplanes, helicopters, ground vehicles, rail transport and marine vessels. PIC cables, connectors and cable assemblies are widely specified for use in major aerospace and military systems throughout the world.



RFMATES®
50 Ohm Coax & Triax



VideoMATES®
75 Ohm Coax & Triax



DataMATES®
Ethernet High-Speed Data/USB



MicroMATES®
Ku Band & X Band



MACHFORCE™
D38999 Style High-Speed
10G Ethernet Connector



www.PICWire.com
phone 1.262.246.0500 toll free 1.800.742.3191



PIC Wire & Cable is a division of The Angelus Corporation, a leading provider of aerospace and defense industry solutions.

TEST REPORT

TEST REPORT

CUSTOMER PIC Wire & Cable
 P/O 123456789
 P/N # 11012-1234-01

TEST FREQUENCY RANGE: 1.02 GHz - 1.12 GHz

CABLE S/N	VSWR (1:____) @ 1.03 GHz	LOSS (dB) @ 1.03 GHz	PHASE (Degrees) @ 1.09 GHz	DELAY (ns)
12397301	1.16	2.77	54.06	14.50
12397302	1.03	2.55	61.91	14.49
12397303	1.09	2.68	46.96	14.59
12397304	1.05	2.78	59.37	14.49
12397305	1.10	2.49	-107.08	13.08
12397306	1.10	2.52	-104.79	13.12
12397307	1.09	2.46	-106.66	13.10
12397308	1.13	2.35	-115.35	13.09

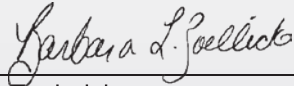
 08/25/2014
 Technician Date

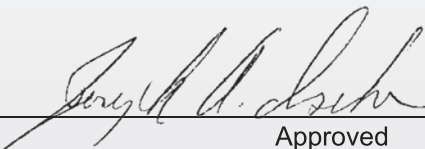
 08/25/2014
 Approved Date

COMPARE PIC 50 OHM COAXIAL CABLES TO STANDARD MIL-SPEC

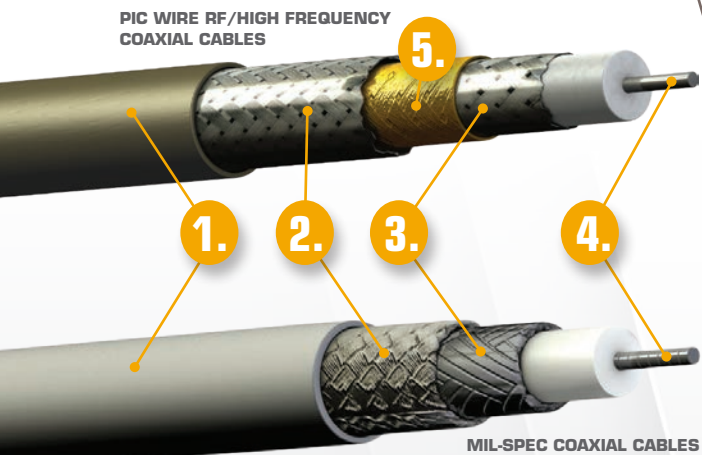

PIC WIRE RF/HIGH FREQUENCY COAXIAL CABLES

MIL-SPEC COAXIAL CABLES

1. FEP Jacket
2. Silver-Plated Copper Round Braid
3. **PIC: Silver-Copper Flat Braid**
PIC: Silver-Copper Strip Braid
Mil: Silver-Copper Round Braid

4. Silver-Plated Copper
PIC: Solid
Mil: Stranded
5. **PIC: Polyimide foil**

At PIC Wire & Cable we're constantly aiming higher—never satisfied in engineering better interconnect products; always focused on providing superior solutions. That applies specifically to our 50 ohm RF and High Frequency Coaxial Cables. While featuring minimum 200°C on all materials for proven quality and reliability, we infuse our State-of-the-Art Design and Manufacturing Experience and Expertise in order to deliver:

Lower Loss > Lighter Weight > Better EMI Immunity

FEATURE	BENEFIT
Inner Flat Braid or Strip Braid	Reduces Loss and Improves EMI Shielding
High Temperature Polyimide Foil	Reduces Loss and Improves EMI Shielding
Dual Braided Shields	Reduce Loss and Improve EMI Shielding
Silver-Plated Copper Throughout	Reduces Loss, Increases Temperature, and Reduces Corrosion
Complete Electrical Specifications	Ensure Reliable System Designs

PIC THE BEST MADE SOLUTION

SUCCESSFULLY DEPLOYED ON MILITARY PLATFORMS: BLUE FORCE TRACKER • CHINOOK • BLACKHAWK • T6

ASSEMBLIES BUILT & TESTED FOR APPLICATION NEEDS

TRI-M3 OR HEAVY NICKEL PLATING*
Superior Corrosion Resistance
*Except ARINC Types (Gold)

PIN CAPTIVATION
Accurate Contact Placement & Retention

CRIMP OR SOLDER
All Contacts

TAPERED, DIAMOND-KNURLED REAR BODY
Superior Braid Retention, Both Axial & Rotational

LABEL PROTECTION
Transparent Heat-Shrink

200°C FEP JACKET
Superior Flame, Fluid & Abrasion Resistance, Low Smoke & Toxicity

EXPANDED* TEFLON® DIELECTRIC
Lighter, Smaller, Tighter Bend Radius Than Solid Extruded Types
*Except S44191 & S44193

GOLD-PLATED CONTACTS

BERYLLIUM COPPER OUTER CONTACT

Positive Spring Contact of Electrical Shield Path

SAFETY WIRE HOLES
(Threaded Nuts Only)
Secure Against Vibration

WEATHER SEAL
Silicone Rubber

INTEGRAL WEATHER SEALS AT BOTH ENDS
Stops Moisture Where it Counts

STRAIN RELIEF
Dual-Wall Shrink Tubing

CRYSTAL-CLEAR LABELING
To Your Specs

SILVER-PLATED OUTER BRAID
No Corrosion, Lower Loss, Higher Temp

MULTI-LAYER SHIELDING CONSTRUCTION
Protection Against EMI & HIRF

SILVER-PLATED COPPER CENTER CONDUCTOR
Low Loss, Especially at GHz Frequencies; Superior Solderability

Making Our Product Superior...
Making Your Job Easier Since 1971

INNOVATIVE AND RELIABLE CABLE SOLUTIONS FOR HONEYWELL INTEGRATED AVIONICS

PIC Wire & Cable has designed, developed and worked with Honeywell to approve the use of the cables below for Honeywell's leading edge **Primus Epic®** and **Apex® Integrated Avionics Systems**.

PIC Cable solutions meet the general performance requirements set forth in the Honeywell Systems' Requirements Document. However, as an important benefit, PIC Cables have been engineered to exceed the general performance requirements of the system and to meet PIC's internal guidelines for cable solutions optimized for aircraft usage. With over 40 years of experience in developing reliable cable solutions PIC has ensured these aircraft cables are designed for the most optimal balance between design features and your total life cycle cost of installing and maintaining the electrical wiring system.

Approved Cable	Epic/Apex Wire Type	EPIC and APEX Interface Application
P/N T12243	ASCB-D Data Bus Cable (125 Ohn TSP)	EPIC ASCB and AV-900 Digital Mic Bus*
P/N T69654	ASCB-C Data Bus Cable (125 Ohn TSP)	Servo CAN Bus, and Digital Audio Bus
P/N L8620TX	50 Ohn Triax Cable	10Base2 Epic LAN Triax (Not for use with GPS antenna)
P/N E51424	LVDS RIB Cable	EPIX APEX System
P/N S86208	50 Ohn Coax	GPS Antenna Coax
P/N E51524	LVDS RIB Cable	Remote Image Bus
P/N V76261	75 Ohn Coax, Double Shielded	Video Camera Coax
P/N F20424	150 Ohn Quad Cable	Fibre Channel Cable
P/N D620224	70 Ohn (differential Z), 2 Conductor	Wx Picture Bus, Data Bus Cable
P/N D611122	70 Ohn (differential Z), 11 Conductor	LSZ-850 Lightning Sensor Antenna Cable
P/N L2201TX	50 Ohn Triax	ADF Antenna Triax

Electrical Wiring System Specifications

- **Flammability.** All Cables meet the Electrical System Components flammability section [(a)(3)] of FAR Part 25 Appendix F, Part 1.
- **Environmental.** All Cables are Skydrol resistant.
- **Internal Component Temperature Rating.** All components of the PIC Cable meet and exceed an upper temperature range of at least 150 degrees C.
- **Jacket Temperature Rating.** The outer jacket of all PIC cable types meets or exceeds an upper temperature range of at least 150 degrees C.
- **Parts Marking.** All specialized PIC cables are marked with the manufacturer and P/N visible on the outer jacket.

Cable and Standard Connectors are available from Stock!
**Can also be used in place of the ASCB-C Data Bus Cable.*

LOW TEMPERATURE VS. HIGH TEMPERATURE

Low Temperature Cables – Rated to +80° C

50 OHM CABLES	CENTER CONDUCTOR		JACKET	IMP.	CAP.	VELOCITY	ATTENUATION @		WEIGHT	SUGGESTED HIGH-TEMPERATURE REPLACEMENT
	AWG	Stranding Material*	O.D. (in)	(Ohms)	(pF/ft.)	of Prop.	400MHz (dB/100ft)	1GHz (dB/100ft.)	(lbs./100ft)	
RG174 (174/U, 174A/U)	24	7/34 CCS	0.100	50	30.8	66%	20.0	31.0	0.8	RG316
RG58 (58A/U)	20	19/33 TC	0.193	50	30.5	66%	13.2	21.5	2.6	PIC P/N's S44191 & S88207, RG142, RG400
RG58 (58C/U)	20	19/33 TC	0.193	50	30.5	66%	14.0	21.5	2.6	PIC P/N's S44191 & S88207, RG142, RG400
RG223 (223/U)	19	SOLID SC	0.211	50	30.8	66%	11.7	16.5	3.4	PIC P/N's S44191 & S88207, RG142, RG400
RG8 (8/U, 8A/U)	13	7/21 BC	0.405	50	29.5	66%	6.0	8.9	10.6	PIC P/N S33141, RG393
RG213 (213/U)	12	7/21 BC	0.405	50	30.8	66%	5.5	8.9	9.9	PIC P/N S33141, RG393
RG214 (214/U)	12	7/21 BC	0.425	50	30.8	66%	5.5	8.9	12.6	PIC P/N S33141, RG393
75 OHM CABLES	AWG	Stranding Material*	O.D. (in)	(Ohms)	(pF/ft.)	of Prop.	400MHz (dB/100ft)	1GHz (dB/100ft.)	(lbs./100ft)	SUGGESTED HIGH-TEMPERATURE REPLACEMENT
RG59 (59B/U)	23	SOLID CCS	0.242	75	20.6	66%	9.0	11.5	3.2	PIC P/Ns V75268 & V76261 & V73263, RG179
RG59 (59A/U)	22	SOLID CCS	0.242	73	21.1	66%	10.5	11.5	3.2	PIC P/Ns V75268 & V76261 & V73263, RG179

*Center Conductor Material Designations:

- BC: Bare Copper
- CCS: Copper Clad Steel
- SC: Silver Coated Copper
- SCCS: Silver Coated Copper-clad Steel
- TC: Tinned Copper

AWG conductor and strand diameters are approximate. All values are nominal.

Note: The low-temperature cables above all have PVC jacket material which fails to meet Federal Aviation Regulations for fire resistance. The high-temperature cables have jacket materials meeting the flame requirements of FAR 25.869, FAR 25.853 and FAR 23 1359(d)

LOW TEMPERATURE VS. HIGH TEMPERATURE

High Temperature Cables – Rated to +200° C

50 OHM CABLES	CENTER CONDUCTOR		JACKET	IMP.	CAP.	VELOCITY	ATTENUATION @		WEIGHT	PIC CABLE ADVANTAGE
	AWG	Stranding Material*	O.D. (in)	(Ohms)	(pF/ft.)	of Prop.	400MHz (dB/100ft)	1GHz (dB/100ft.)	(lbs./100ft)	
RG316	24	7/33 SCCS	0.102	50	29.4	69%	20.0	30.0	1.2	
PIC P/N S86208	21	7/28 SC	0.130	50	25.0	80%	8.9	14.1	2.0	Smaller and lighter than RG142/RG400
PIC P/N S88207	20	SOLID SC	0.130	50	25.0	80%	8.0	12.8	1.9	Lower Loss than RG142/RG400
PIC P/N S44191	20	19/.008 SC	0.195	50	29.3	69.5%	7.3	11.8	4.3	Lower Loss than RG142/RG400
PIC P/N S44193	19	SOLID SC	0.195	50	29.3	69.5%	6.8	11.1	4.3	
RG142 (142B/U)	20	SOLID SCCS	0.195	50	29.4	69%	9.0	13.0	5.0	
RG142 (142A/U)	20	SOLID SCCS	0.195	50	29.4	69%	9.0	13.0	4.7	
RG400 (400/U)	19	19/32 SC	0.195	50	29.4	69%	9.6	13.0	5.0	
PIC P/N S67163	15	SOLID SC	0.230	50	25.0	80%	4.4	7.0	5.4	Smaller, lighter and lower loss than RG393
PIC P/N S33141	14	7/.023 SC	0.270	50	25.0	80.5%	4.2	6.7	6.5	Smaller, lighter and lower loss than RG393
PIC P/N S55122	12	7/.0312 SC	0.310	50	24.0	84.5%	3.2	5.1	8.3	Smaller, lighter and lower loss than RG393
RG393	12	7/20 SC	0.390	50	29.4	69%	5.0	7.5	16.5	
75 OHM CABLES	AWG	Stranding Material*	O.D. (in)	(Ohms)	(pF/ft.)	of Prop.	400MHz (dB/100ft)	1GHz (dB/100ft.)	(lbs./100ft)	PIC CABLE ADVANTAGE
RG179 (179A/U)	28	7/38 SCCS	0.100	75	19.5	69%	21.0	25.0	1.0	
RG179 (179B/U)	28	7/38 SCCS	0.100	75	19.5	69%	21.0	25.0	1.0	
PIC P/N V75268	26	19/38 SC	0.122	75	16.0	80%	10.7	-	1.3	Center conductor > 2x Tensile strength RG179
PIC P/N V76261	26	19/38 SC	0.123	75	16.0	80%	10.2	-	1.1	Center conductor > 2x Tensile strength RG179
PIC P/N V73263	26	19/38 SC	0.130	75	16.0	80%	10.2	-	1.5	Center conductor > 2x Tensile strength RG179

*Center Conductor Material Designations:

- BC: Bare Copper
- CCS: Copper Clad Steel
- SC: Silver Coated Copper
- SCCS: Silver Coated Copper-clad Steel
- TC: Tinned Copper

AWG conductor and strand diameters are approximate. All values are nominal.

Note: The low-temperature cables above all have PVC jacket material which fails to meet Federal Aviation Regulations for fire resistance. The high-temperature cables have jacket materials meeting the flame requirements of FAR 25.869, FAR 25.853 and FAR 23 1359(d)

PIC 50 OHM CABLES

It has been acknowledged for many years that an important goal in the selection of materials for the construction of aircraft interiors is the combustibility of such materials. While fire can result from many causes, at a minimum, such materials ought not be the primary cause of fire, nor should they become a large fuel source for a fire emanating from any other cause. Further, even if such materials will burn, they ought not exude large quantities of smoke and fire effluent which may result in personal injury, nor melt in flaming drips which could propagate the flames.

This is a serious concern in the confined space of an aircraft, where access to fire control is limited and leaving the scene is a drastic or non-existent option. While no one enjoys the prospect of facing the dangers of fire on the ground, there is at least the possibility of leaving the premises and/or fighting the outbreak with the facilities of a fire department.

And yet we know that the presence of combustible fuel and electrical currents are unavoidable – on the ground, or in the air. For aircraft, these concerns are at the center of attention even today as the investigations into the cause of the TWA Flight 800 disaster continue.

The FAA has for years included tests and specifications relating to materials selection in its certification standards for all aircraft. And yet, the argument is made that even the FAA's attention to this issue and the standards for acceptability are inadequate, especially with the present availability of materials having excellent characteristics in both resisting the support of flames and the resulting generation of smoke and fire effluent.

Still, older, once acceptable wire insulation materials such as PVSC find their way into some new installations – allowing that there are many cases where PVC has been in place, albeit perhaps ignorantly, for many years before modern chemistry yielded inexpensive and proven fire-resistant plastics. Among these are Teflon and the so called Low-Smoke Zero-Halogen (LSZH) insulating materials.

But even LSZH carries with it a greater risk of developing large fires than the Teflon family – a risk we believe to be so serious as to call for more stringent FAA standards, and more concern on the part of everyone associated with the aerospace industry.

Low-Smoke Zero-Halogen wire insulation came into its present strength on the coattails of a shortage of Teflon in 1995. While LSZH has been used with the blessing of UL (Underwriter's Laboratories) and other governing bodies for "plenum" installation of computer and telephone wiring for many years, Teflon was the preferred insulation until the shortage developed – and at just a time when computer networks were proliferating. DuPont, the developers of Teflon (and, for that matter, a number of LSZH compounds) has made an important issue of the comparative merits of Teflon.

LSZH insulation is derived from polyolefin, and is usually a member of the polyethylene or polypropylene family. Additives to these comparatively fuel-rich materials are essential to becoming classified as specifically "low-smoke". By their chemistry, they are already zero-halogen, but not free of toxicity when burned, and soften or melt at lower temperatures than does Teflon.

The widespread use of LSZH insulation – although an improvement over PVC – has brought with it the assumption that it is entirely adequate for use in aircraft wiring. And while it may pass the FAA's meager test requirements, it is a potentially tragic disservice to people who fly to be led to believe the cabin is as free of fire hazards as it could reasonably be.

DuPont has issued the enclosed paper, delivered to an industry standards committee (BICSI, for Building Industry Consulting Services, International) concerned not with aircraft safety but with the on-ground risks associated with plenum wiring for computer networks and telecommunications systems. The report is dramatic in its own context, but the extrapolation is at least eye-opening. Note that the setup for the Steiner Tunnel tests bears some physical resemblance to the confined envelope of an airplane fuselage.

We invite your study of this paper and believe that, once informed, you will agree that there is work to be done to assure the safety of life in the confined atmosphere of an airplane when disaster occurs.

Since entering the avionics cable scene in 1978, PIC has consistently employed Teflon or its derivatives as the insulation material of choice. It is – and has been – our unwavering decision not to compromise the benefits with respect to fire safety for other advantages, such as (primarily) cost, flexibility, or availability.

CABLE ASSEMBLY SOLUTIONS FOR GOGO AVANCE SYSTEMS

PIC Wire & Cable® developed a series of cable assemblies approved for use with Gogo® Business Aviation's AVANCE™ L3, L5 and L5i data connectivity systems and is listed in system manuals. Assemblies are customizable and designed to meet an application's unique loss, length, weight and flexibility requirements. Pre-engineered assembly drawings are available to simplify the US Federal Aviation Administration (FAA) submission process for modifications and installations.

Proper cable assembly is critical to optimizing the full benefits of interconnect technology. PIC Wire & Cable's internal assembly facility provides certified, tested and phase matched assembly sets to simplify the system installation process.

AVANCE Cable Options

PIC Wire & Cable offers a variety of RFMATES® and RFMATES ULTRALITE® cable solutions that meet or exceed AVANCE system performance requirements. These high quality cables were specially designed as low loss options, with the ULTRALITE line optimized for applications that require lightweight, flexible cables.

Maximum Cable Length (Inches) by Application

Cable P/N	Weight lbs/100 ft (kg/100 m)	Bend Radius in (mm)	WIFI (5.0 GHz)		TM (1.8 GHz)		Directional (0.9 GHz)		Omni-Directional (0.9 GHz) *L3 Only
			Optimal Loss (3 dB)	Max Loss (5 dB)	Optimal Loss (3 dB)	Max Loss (5 dB)	Optimal Loss (1 dB)	Max Loss (3 dB)	Max Loss (3.48 dB)
S86208	2.0 (2.9)	0.65 (16.51)	84	156	156	264	60	228	264
S33141	6.5 (9.7)	1.40 (35.56)	174	312	300	540	132	444	516
S55122	8.3 (12.4)	1.55 (39.37)	216	408	396	708	174	588	696
S22089	18.0 (26.8)	2.50 (63.50)	N/A	N/A	N/A	N/A	258	852	1008
UH44193	1.9 (2.9)	0.80 (20.32)	108	198	198	348	84	288	348
UH67163	3.4 (5.1)	1.20 (30.48)	180	336	336	600	144	480	588
UH22089	7.2 (10.7)	1.70 (43.18)	324	600	600	1068	252	852	1020
UH25107	12.0 (17.9)	2.50 (63.50)	N/A	684	N/A	N/A	312	1080	1284

AVANCE Connector Options

PIC Wire & Cable also has several matching SMA and TNC connectors for its RFMATES and RFMATES ULTRALITE cables to meet unique application requirements.

Cable P/N	SMA Str. Plug	TNC Str. Plug	TNC 90 Plug
S86208	190814	190808	190809
S33141	190314	190308	190309
S55122	190614	190608	190609
S22089	N/A	190408	190409
UH44193	150114	150108	150109
UH67163	150514	150508	150509
UH22089	150414	150408	150409
UH25107	N/A	190408	190409

Assembly Part Number Builder

Accelerate the cable assembly procurement process by building a part number with design details that meet an application's specific requirements. Ready to use engineering drawings are provided to streamline the FAA submission process for part modifications and installations.

Engineering drawings for cable assemblies are available for download at www.picwire.com/assemblies/assembly-worksheets.

Sample Part Number: 11012 - **V** **W** **X** **YYYY** - **ZZ**

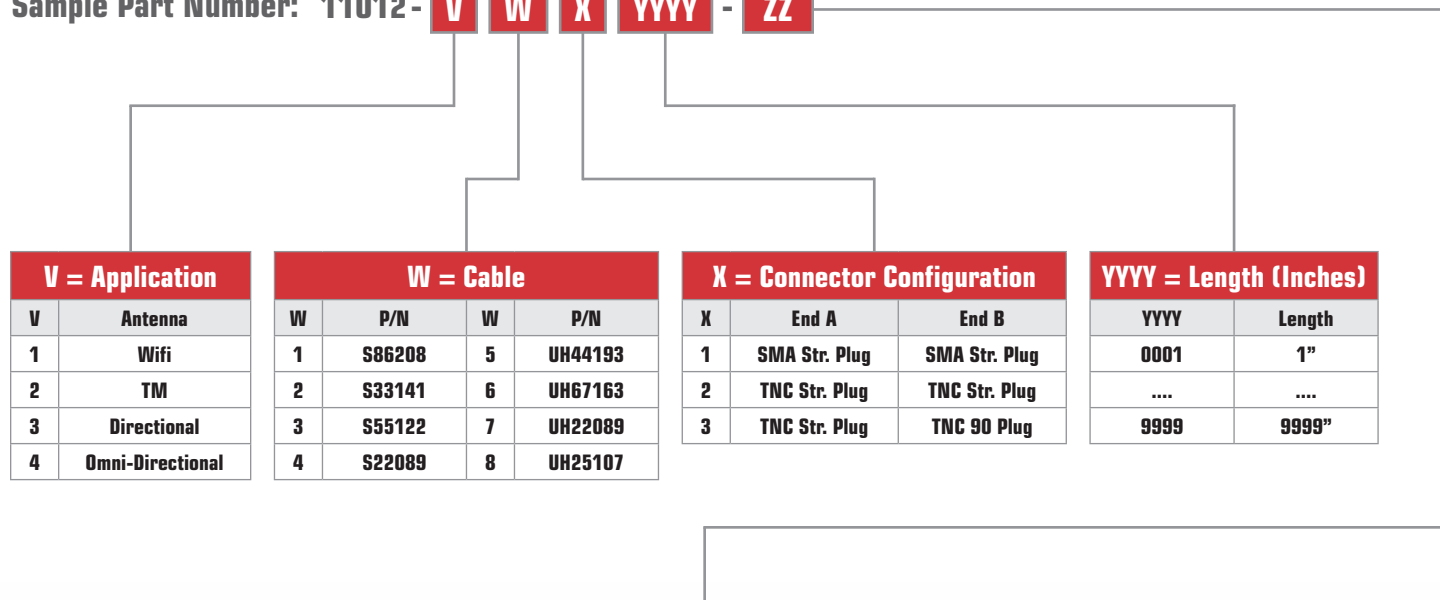

V = Application	
V	Antenna
1	Wifi
2	TM
3	Directional
4	Omni-Directional

W = Cable			
W	P/N	W	P/N
1	S86208	5	UH44193
2	S33141	6	UH67163
3	S55122	7	UH22089
4	S22089	8	UH25107

X = Connector Configuration		
X	End A	End B
1	SMA Str. Plug	SMA Str. Plug
2	TNC Str. Plug	TNC Str. Plug
3	TNC Str. Plug	TNC 90 Plug

YYYY = Length (Inches)	
YYYY	Length
0001	1"
....
9999	9999"

ZZ = Sub System Designator														
ZZ	Sub System	AVANCE	ZZ	Sub System	AVANCE	ZZ	Sub System	AVANCE	ZZ	Sub System	AVANCE	ZZ	Sub System	AVANCE
01	TM 1	L3 & L5	05	WIFI 3	L3 & L5	09	ATG1 FWD V1	L3	13	ATG1 FWD H1	L5	17	ATG2 FWD V1	L5
02	TM 2	L3 & L5	06	WIFI 4	L3 & L5	10	ATG1 FWD H1	L3	14	ATG1 RIGHT H2	L5	18	ATG2 RIGHT V2	L5
03	WIFI 1	L3 & L5	07	WIFI 5	L3 & L5	11	ATG1 AFT V2	L3	15	ATG1 AFT H3	L5	19	ATG2 AFT V3	L5
04	WIFI 2	L3 & L5	08	WIFI 6	L3 & L5	12	ATG1 AFT H2	L3	16	ATG1 LEFT H4	L5	20	ATG2 LEFT V4	L5

CABLE ASSEMBLY SOLUTIONS FOR SMARTSKY 4G SYSTEMS

PIC Wire & Cable® offers custom cable assemblies that are specifically designed for use with SmartSky Network's 4G LTE data connectivity. The SmartSky 4G LTE system is SmartSky Networks' newest in-flight connectivity solution designed to deliver the same data connectivity experience in air as passengers would experience on the ground. To ensure the system's continuous connectivity and high speed data rates, a reliable interconnect assembly is required. PIC Wire & Cable's assemblies are customizable and designed to meet an application's unique loss, length, weight and flexibility requirements.

Proper cable assembly is critical to optimizing the full benefits of interconnect technology. PIC Wire & Cable provides certified and tested assembly sets to streamline the system installation process. Engineering drawings are available to simplify the US Federal Aviation Administration (FAA) submission process for part modifications and installations.

Cable Options

PIC Wire & Cable offers a variety of RFMATES® and RFMATES ULTRALITE® cable solutions that meet or exceed SmartSky 4G LTE system performance requirements for RF loss and VSWR. These high performance cables were specially designed with low loss characteristics, that ensure signal reliability. The RFMATES ULTRALITE line is engineered with additional shielding protection and optimized for applications that require lightweight, flexible cables.

All RFMATES and RFMATES ULTRALITE cables have undergone a variety of EWIS tests, such as flammability and immersion fluid testing, including Skydrol. EWIS test reports are available upon request.

Cable Length and Loss							
Cable P/N	Physical Characteristics		Maximum Cable Length (Inches) by Application			Cable Loss db/ft	
	Weight lbs/100 ft (kg/100 m)	Bend Radius in (mm)	ABR P9 to FDQ-P2 (2.483 GHz) Max Loss 3.0 dB	ABR P4 to FDQ-P3 (2.483 GHz) Max Loss 6.0 dB	ABR - HPB 4 Cables (1.6 GHz) Max Loss 10.0 dB	1.6 GHz	2.483 GHz
UH25107	12.0 (17.9)	2.50 (63.50)	612	1318	2880	0.04	0.051
UH22089	7.2 (10.7)	1.70 (43.18)	512	1100	2351	0.061	0.049
UH67163	3.4 (5.1)	1.20 (30.48)	286	616	1324	0.087	0.109
UH44193	1.9 (2.9)	0.80 (20.32)	167	362	784	0.147	0.186
S22089	18.0 (26.8)	2.50 (63.50)	503	1083	2351	0.049	0.062
S55122	8.3 (12.4)	1.55 (39.37)	346	747	1600	0.072	0.09
S33141	6.5 (9.7)	1.40 (35.56)	260	560	1226	0.094	0.12
S44191	4.3 (6.4)	1.00 (25.40)	147	317	690	0.167	0.212
S86208	2.0 (2.9)	0.65 (16.51)	127	273	588	0.196	0.246

Table 1

Connector Options

PIC Wire & Cable has matching TNC connectors for its RFMATES and RFMATES ULTRALITE cables that are designed per MIL-PRF-39012 standard. See Figure 1 for a connector illustration detailing the construction elements that ensure signal integrity while protecting against fluid and vibration.

Cable P/N	TNC Str. Plug	TNC 90 Plug
UH25107	190408	190409
UH22089	150408	150409
UH67163	150508	150509
UH44193	150108	150109
S22089	190408	190409
S55122	190608	190609
S33141	190308	190309
S44191	190108	190109
S86208	190808	190809

Table 2

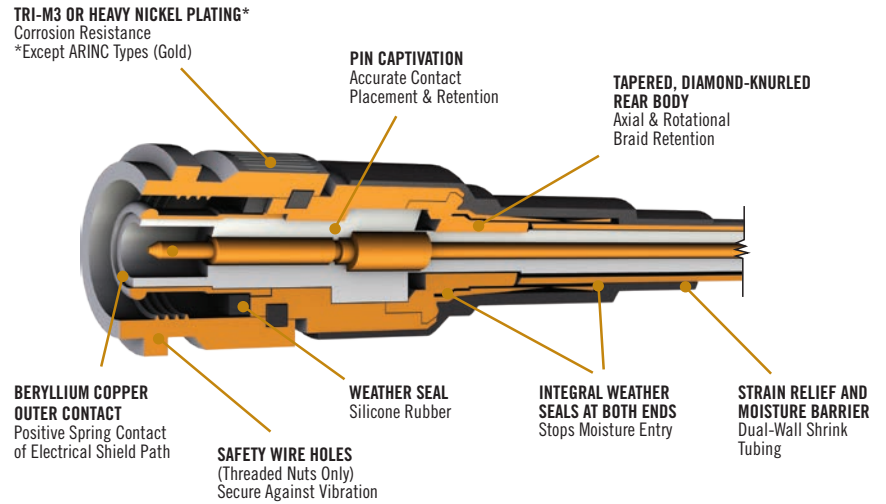

Figure 1

Assembly Part Number Builder

Easily build a part number with design details that meet the application's specific length and connector requirements. Ready to use engineering drawings are available to streamline the US Federal Aviation Administration (FAA) submission process for part modifications and installations.

SmartSky cable assembly drawings are accessible for download at www.picwire.com/assemblies/assembly-worksheets.

Sample Part Number: 34618- **A B C DDDD**

A = Assembly Application			B = Cable				C = Connector Configuration			DDDD = Assembly Length	
A	End A (From)	End B (To)	B	P/N	B	P/N	C	End A (ABR)	End B (FDQ & HPB)	DDDD	Length (in)
1	ABR P9	FDQ-P2 /TX	1	UH25107	6	S55122	1	TNC Straight	TNC 90	0001	1"
2	ABR P4	FDQ P3/RX	2	UH22089	7	S33141	2	TNC 90	TNC Straight
3	ABR P5	HPB/RX1	3	UH67163	8	S44191	3	TNC 90	TNC 90	2952	2952"
4	ABR P3	HPB/RX2	4	UH44193	9	S86208	4	TNC Straight	TNC Straight		
5	ABR P7	HPB/RX3									
6	ABR P6	HPB/GPS									

Table 3

CABLE ASSEMBLY SOLUTIONS FOR HONEYWELL CNX 900

PIC Wire & Cable® offers custom cable assemblies that are approved for use with Honeywell's CNX® 900 cabin network router and listed in the system manual. The CNX 900 offers a fast and secure wireless in-flight data connection with increased bandwidth for larger downloads and video streaming. To ensure the system's continuous connectivity and high speed data rates, a reliable interconnect assembly is required. PIC Wire & Cable's assemblies are customizable and designed to meet an application's unique loss, length, weight and flexibility requirements.

Cable and Connector Options

PIC Wire & Cable offers a variety of RFMATES® and RFMATES ULTRALITE cable and connector solutions that meet or exceed system performance requirements for RF loss and VSWR. These high performance cables are specially designed with low loss characteristics that ensure signal reliability. The RFMATES ULTRALITE line is engineered with additional shielding protection and optimized for applications that require lightweight, flexible cables.

All RFMATES and RFMATES ULTRALITE cables have undergone a variety of EWIS tests, such as flammability and immersion fluid testing, including Skydrol. EWIS test reports are available upon request.

Cable Physical and Electrical Characteristics

Cable P/N	Max Loss in db/100 feet at 1.99 Ghz	Max Loss in db/100 feet at 2.4 Ghz	Max Loss in db/100 feet at 5.0 Ghz	Weight lbs/100 ft (kg/100m)	Bend Radius Inch (mm)
S31601	42.49	47.28	72.64	1.0 (1.5)	0.5 (12.70)
S86208	21.98	24.18	35.21	2.0 (2.9)	0.65 (16.51)
S67163	10.94	12.06	17.71	5.4 (8.0)	1.2 (30.48)
S55122	7.31	8.88	13.15	8.3 (12.4)	1.55 (39.37)
UH44193	16.54	18.25	26.92	1.9 (2.9)	0.8 (20.32)
UH67163	9.73	10.74	15.87	3.4 (5.1)	1.2 (30.48)
UH22089	5.49	6.06	9.98	7.2 (10.7)	1.7 (43.18)

Connector Options by Cable

Cable P/N	ARINC Size 5 Socket	ARINC Size 12 Socket	TNC Str Male	TNC 90 Male	TNC Inline Jack	TNC Bulk Head Jack
S31601	110928	110981	110872	110874	110983	110930
S86208	190803	X	190808	190809	X	190821
S67163	111122	X	190508	190509	190523	190521
S55122	X	X	190608	190609	190623	190621
UH44193	150103	X	150108	150109	X	150121
UH67163	150503	X	150508	150509	150523	150521
UH22089	X	X	150408	150409	X	150421

Pre-Engineered Assemblies

Proper cable assembly is critical to optimizing the full benefits of interconnect technology. PIC Wire & Cable provides certified and tested assembly sets to streamline the system installation process. Engineering drawings are available to simplify the US Federal Aviation Administration (FAA) submission process for part modifications and installations.

Download pre-engineered drawings at www.PICWire.com/assemblies/assembly-worksheets.

The Loss Prevention Council Fire Safety Seminar

20th February 1998, Borehamwood, United Kingdom

Lucent Technologies
Bell Labs Innovations



BICCBrand-Rex



DuPont

Full-Scale UK Fire Tests of LAN Data Communications Cables Used in Concealed-Space Applications, Rev. 1

OBJECTIVES

This paper evaluates the fire performance of commercial data communications cables (and materials) in:

1. Full-scale tests simulating current UK installation practices.
2. Intermediate-scale Steiner Tunnels (NFPA 262-1990 or UL-910) used in Canada, Japan, Mexico, and the USA.²
3. Small-scale Tube-Furnace tests in UK apparatus designed to evaluate fire effluent.

INTRODUCTION

In buildings worldwide, the installation of combustibles in concealed spaces is an important concern because of the potential for undetected spread of fire and smoke throughout the building.¹

A series of large devastating fires have recently occurred in buildings involving combustibles in concealed spaces (see Reference 11 for listing of fires).

In the UK, the proliferation of local area networks (LANs) in buildings can result in heavy concentrations of communications cables in concealed spaces (see Figure 25).

Common LAN cable constructions in the UK include compounded PVC or compounded polyolefin (non-halogen) sheathing over polyethylene or polypropylene based insulations on the copper conductors. Non-halogen cable constructions are often designated LSZH (for Low Smoke Zero Halogen).⁷

Typically, LSZH polyolefin base polymers have high fuel loads and are highly combustible. Therefore, they are compounded with metal-hydrate fillers to delay ignitability until the water of hydration is exhausted. Vigorous combustion can then result.

In contrast, construction products used in concealed spaces are usually required to be non-combustible or limited combustible.

Full-scale fire tests simulating UK installation practices were conducted at BRE/FRS (Building Research Establishment/Fire Research Station) Cardington. The test program was designed to support the development of new performance data for hazard assessments, international fire test protocols and fire safety engineering.

The earlier tests were carried out in a burn-room/concealed-space re-burnable structure with a nominal 1-megawatt

wood crib source-fire. The later tests used a nominal 1-megawatt gas burner. Fire scenarios, ventilation conditions, and LAN cable designs and configurations were varied.

Fire performance measurements included mass loss, pressure differentials, lateral flame spread, heat flux, vertical temperature profiles, smoke opacity, heat release, CO and CO₂ generation and O₂ depletion. Tests were documented with still and video photography in both IR and white light.

Most data were logged electronically (about every 10 seconds) for real-time on-line graphical monitoring, and then stored in spreadsheet formats to facilitate statistical analysis and computer modeling.

LSZH cables that pass IEC 332-1 and IEC 332-3 ignited readily and burned the full length of the concealed space configuration. A large fire-ball developed on the horizontal cable ladder and a pool of fire formed on the suspended ceiling beneath the cable ladder in the concealed space. Ceiling tiles often fell out during tests.

Under the same full-scale test conditions, LAN cables that pass NFPA 262 (Steiner Tunnel) test criteria showed no sign of flame spread and generated little smoke.² These cables are designated CMP in North America, Canada, Mexico and Asia (see Experimental section below).

Other related tests were conducted in the intermediate-scale Steiner Tunnel and in the small-scale tube furnace/smoke box apparatus developed for the British Cable Makers Confederation (BCMC).

The cable fire performance (flame, spread, smoke and heat release) data from the Steiner Tunnel was relatable to the BRE/FRS full-scale simulations. The data from the IEC 332-1 and IEC 332-3 tests was not relatable.

Steiner Tunnel facilities have now been installed in Europe by BRE/FRS and by the LPC (Loss Prevention Council) to help companies develop higher fire performance cables intended for use in horizontal concealed spaces.

Surprisingly, dense dark smoke and forceful explosions occurred with just one gram of polyolefin cable materials from the LSZH cables in the BCMC small-scale apparatus tests (see Figure 23). The CMP cable materials produced very little smoke and no explosions in the same small-scale BCMC tests. These explosions may relate to flashover phenomena.

BACKGROUND

Worldwide, ceiling and floor concealed spaces (voids) in commercial buildings are increasingly being used for utilities and ventilation. This design approach helps maximize flexibility in meeting changing tenant churn requirements.

Many new and refurbished buildings use concealed spaces to contain communication and power cables, plumbing, fire detection and suppression systems and similar mechanical and electrical services. Sometimes the same space is used for environmental air handling. Installing services in concealed spaces provides convenient access, easy alterations, lower construction costs and energy conservation for heating, ventilation and air conditioning (HVAC).

If these concealed spaces contain combustibles, they are potential sites for the undetected generation and movement of fire and smoke.¹¹

Historically, this has meant that construction products exposed in the concealed spaces have been required to be (a) fire partitioned, or be (b) very low in fuel-load and combustibility, or be (c) protected by either fire resistant coverings or fire extinguishment systems. In the past, these options have been found to be acceptable.¹

However, with the growing use of concealed spaces for cabling, new fire-path and fire-load problems are emerging (see Figure 26). LANs are growing at 25%/year in many regions and LAN cabling systems are being replaced every 3 to 5 years as personal computers (PC's) become faster and more powerful. As a result, many concealed spaces are becoming filled with multiple generations of data communications cables with low or unknown aggregate fire performance.

EXPERIMENTAL

Products Tested

Commercial cables were selected that met a range of available fire performance.

The tests were conducted with commercially obtained 4-pair sheathed unshielded twisted pair (UTP) communications data cables. These cables are typically installed in horizontal concealed spaces to connect PCs to LANs in Structured Wiring Systems. According to Lucent/AT&T surveys, the 200 seven-meter lengths of cable used in each test represent about one generation of cable in a typical one-floor open-plan office layout. More than one generation of installed cable is often present in actual buildings.

CMX is a low fire performance communications cable used in the USA that is required to be installed in protective metallic conduit in plenums (concealed spaces).³ CMX/T is CMX cable installed in capped steel trunking, sometimes used for communication cables in the UK (see Figure 27).

CMP is a high fire performance communications cable (per NFPA 262 or UL-910) used in the USA in plenum cavity voids without requirements for protective metallic conduits or trunking. Low fuel-load fluoropolymers like Teflon® FEP are commonly used for insulations in CMP rated cables (see Figure 21).

LSZH communications cable per IEC 332-1 and IEC 332-3 is used in the UK and some European countries, often without trunking. High fuel-load polyolefins and flame retardant

polyolefins (FRPE) are often used in LSZH cables (see Figure 21).

Full-Scale Tests (BRE/FRS Cardington, UK)

The full-scale test rig was a 7.4m x 5.7m x 4m high concrete block burn-room/ceiling-void re-burnable structure with a 2-hour fire rated suspended ceiling. The above-ceiling concealed space is 1m deep (see Figure 1).

The source fire was created with a nominal 150kg. crib of kiln-dried pinus sylvestris with 20% moisture. This fuel was stored in conditioning rooms until used. One hundred sticks, 60mm x 60mm x 1m, were stacked 10 per row in 10 rows to generate a nominal 1-megawatt fire over 30 minutes.

The 1-megawatt intensity was chosen to simulate a fire in an office workstation. Recent National Institute of Standards and Technology (NIST) research indicates such workstation fire energies can typically range from 2 to 6 megawatts.

The wood crib calibrations in the BRE/FRS full-scale calorimeter showed very linear mass loss after about 8 minutes from ignition. However, the energy output ramped up sharply until about 10 minutes into the burn and then plateaued until about 20 minutes. The energy output then ramped up again from 20 minutes until about 30 minutes.

The air extraction system was capable of 4.5m³/sec. The hot gas and smoke from the crib fire entered the cavity void through a breach (hole) in the suspended ceiling directly over the crib and were then extracted through vents at the far end of the overhead concealed space.

Cables were supported on a steel ladder 7.2m long by 0.38m wide. The ladder was located midway between the suspended ceiling and the structural ceiling of the test rig.

Thermocouples (TCs) arrayed vertically in the burn room provided data for mapping temperature profiles. Other thermocouples arrayed horizontally and vertically in the void space provided data for mapping both temperature profiles and flame spread (see Figure 1, bottom; and Figures 18 and 19).

The baseline performance of the source fire and test apparatus without cable combustibles was determined by operating the system with an insulated board on the ladder in place of cable.

Figures 10, 11, 12, 13 and 14 are photographs illustrating the test apparatus.

Additional test apparatus details are presented in an Interflam '96 paper entitled "Cables Fires In Concealed Spaces . . . A Full-Scale Test Facility For Standards Development" by P. Fardell, S. Rogers, D. Smit, R. Colwell, BRE/Fire Research Station, UK.

Full-Scale Results (BRE/FRS Cardington, UK)

The CMX/T and CMP cables exhibited very low smoke optical densities and heat release. No burning was visible beyond the suspended ceiling breach area.

The CMX and LSZH cables released comparatively large amounts of heat. These cables burned the full length of the plenum space and developed large fire-balls on the ladder and large pool fires on the suspended ceiling. The LSZH smoke density was higher than that of either CMX/T or CMP, but notably lower than CMX (see Figures 2, 3 and 4). In addition,

LSZH cables also produced more smoke and CO than expected (see Figures 5 and 6). CMP cables had the lowest smoke and CO (see Figure 3 and 6).

Downstream peak temperatures along the entire length of the ladder exceeded 800°C when exposed LSZH cables burned (see Figure 18). CMX downstream peak temperatures averaged slightly under 775°C. Recent British Steel Technical fire tests at BRE/FRS indicate that temperatures exceeding 800°C can allow loaded structural steel beams to severely deform (see Figure 22).⁸

CMP downstream peak temperatures averaged less than 335°C (see Figure 19). Baseline downstream peak temperatures with no combustibles in the plenum void averaged slightly under 325°C in calibration tests.

Figures 14, 15 and 16 are photographs illustrating the fire performance of LSZH cables. Figure 17 shows no flame spread with CMP cables under similar conditions.

Steiner Tunnel Tests (Underwriters Laboratories)

The intermediate-scale horizontal tray tests were conducted per NFPA 262-1990, Test for Fire and Smoke Characteristics of Wires and Cables² (UL-910) which is a modification of the 7.6m Steiner Tunnel³ used for cables and construction products.

In this method, an array of cables 0.3m wide and 7.6m long is strung beneath the ceiling on a ladder extending for the length of the tunnel. A diffusion gas burner flame of 90kW (nominal) engulfs up to 1.5m of the cable at the far upstream end. Ventilation is supplied from the burner end at a linear flow rate of 73m per minute.

Cables for plenum use are required to spread flame no more than 1.5m past the burner flame tip and produce a peak smoke optical density no greater than 0.5 ($\log I_0/I$) and an average smoke optical density no greater than 0.15 ($\log I_0/I$) in the exhaust duct.^{1,2}

These performance requirements were selected so that approved exposed cable would compare favorably with cable protected in metal conduit when exposed to the same test conditions.^{4,5,6} Additional measures of O₂ consumption made to calculate heat release are not mandatory today.

All results were comparable to the full-scale results (see Figures 7, 8 and 9). Further thermal and statistical analyses are in progress.

The fire performance of the IEC 332-1 and IEC 332-3 rated LSZH cables were similar to each other in both the BRE/FRS full-scale tests and in the Steiner Tunnel (with relative fuel-limited combustion conditions).

Tube Furnace Tests (Underwriters Laboratories)

Dense dark smoke and forceful double explosions occurred with just one gram of polyolefin insulation material from LSZH cables in small-scale tests utilizing the tube furnace/smoke box apparatus developed for the British Cable Makers Confederation (see Figure 23). These tests were being run to assess fire effluent damage on computer micro-circuits when the explosions unexpectedly occurred with LSZH cable materials.

Fluoropolymer insulation materials from the high fire performance CMP cables, tested under the same conditions, did not explode and did not generate dense dark smoke.

Further study is underway to see if these explosions with LSZH cable materials relate to similar explosive flashback, backdraft and flashover phenomena encountered in large building fires.

Combustion Toxicity Considerations

The comparative carbon monoxide (CO) generation shown in Figures 5 and 6 is one of many evaluations needed to assess toxic hazards over a range of fire scenarios.

Figure 24 shows a comparison of the bio-confirmed toxicity of the fluoropolymer category of electrical materials typically used in CMP cables versus the polyolefin category of electrical materials typically used in LSZH cables. Similar data for PVC is shown in Figure 24a. This data was developed by the National Electrical Manufacturers Association (NEMA) using the NYS/NEMA protocol that subjects products to a continuous range of ramped fire scenarios.¹⁰

There was no significantly discernible difference in toxicity (LC₅₀) between the fluoropolymer and the polyolefin categories. This is likely due to the tendency for polyolefins to generate large amounts of CO, especially in situations where they burn rapidly and quickly reduce available oxygen (i.e., concealed spaces). Toxicity information should be used as part of a relevant total fire hazard assessment where parameters such as ignitability, fuel load, heat release, flame spread and smoke opacity are also considered.

CONCLUSIONS

1. The data obtained in the Steiner Tunnel was relatable to the full-scale BRE/FRS simulations.
2. The fire performance of the exposed CMP cable was comparable to CMX cable in metal trunking (CMX/T) in the BRE/FRS full-scale and Steiner Tunnel tests.⁶
3. The flame spread, heat release and smoke opacity results for exposed CMP cable were significantly lower than results for exposed LSZH and CMX cable.
4. For LSZH cables, the high temperatures, high heat release rates, flame spread, fire-balls, pool fires and tube furnace explosions were unexpected considering their extensive use in concealed spaces in commercial buildings.
5. There was no discernible difference in toxicity between the fluoropolymer category of materials used in CMP cables versus polyolefin and PVC categories of materials used in the LSZH cables per NEMA data.¹⁰

FUTURE WORK

These and other cables are being evaluated with variations in source fires, ventilation, installation configuration, fuel loads, fire loads and fire scenarios. Data for concealed space fire modeling is also being developed.

AUTHORS AND PRESENTERS

Dr. J. Thomas Chapin and T. C. Tan, Lucent Technologies
Arthur Willis and Dr. Keith Pye, BICC Brand-Rex
James R. Hoover and Loren M. Caudill, DuPont

REFERENCES

- 1 F. Clark, J. Hoover, L. Caudill, A. Fine, A. Parnell & G. Butcher, "Characterizing Fire Hazard of Unprotected Cables in Over-Ceiling Voids Used for Ventilation," Interflam '93, page 259, 1993.
- 2 "Test for Fire and Smoke Characteristics of Wires and Cables", NFPA 262-1990, National Fire Protection Association, Quincy, Mass., USA, 1990.
- 3 cf. "Standard Test for Surface Burning Characteristics of Materials", ASTM E84-87, ASTM, Philadelphia, Pa, USA, 1987.
- 4 L. Przybyla, E. J. Coffey, S. Kaufman, M. Yocum, J. Reed and D. Allen, "Low Smoke and Flame Spread Cables", Journal of Fire and Flammability 12, 177 (1987).
- 5 S. Kaufman and M. Yocum, "Behavior of Fire-Resistant Communications Cables in Large-Scale Fires", Plastics and Rubber: Materials and Applications, November, 1979, 149.
- 6 L. Przybyla, E. Coffey, S. Kaufman, M. Yocum, J. Reed, D. Allen, "Low-Smoke and Flame Spread Cables", The 28th International Wire and Cable Symposium Proceedings, Cherry Hill, N.J., USA, 1979.
- 7 See Figure 20 for a relative ranking of fire performance among various fire tests, ref NFPA 70 and UL reports.
- 8 Kirby, B.R., "British Steel Technical European Fire Test Programme", Fire, Static and Dynamic Tests of Building Structures; Armer, G. & O'Dell, T., (1997), pp. 111-126, Conference Proceedings.
- 9 Hoover, J., "Full-Scale Fire Research on LAN Cables in Concealed Spaces", BICSI Presentation Summaries, January 1997, pp. 3-16, Winter Conference, Orlando, FL.
- 10 National Electrical Manufacturers Association, 1987, "Registration Categories of the National Electrical Manufacturers Association for Compliance with the New York State Uniform Fire Prevention and Building Code", R. Anderson, P. Kopf, pub., Arthur D. Little, Inc.
- 11 These fires included the Dusseldorf Airport in April '96, the Paris Credit Lyonnais Bank in May '96, the New York Rockefeller Center in October '96, the Hong Kong Golden Mile, Garly Building in November '96, the Bangkok Presidential Tower (36-story office complex) in February '97 and Heathrow Airport in December '97, among many others.

ACKNOWLEDGEMENTS

A special thanks is due to the following people who have provided valuable professional advice over the course of this work:

A. Fine, J. Hardiman and S. Kaufman, AT&T*, Norcross, Ga., USA

L. Przybyla, P. Gandhi, T. Ebert, W. Metes, R. Backstrom and J. Resing, UL, Northbrook, Ill., USA

A. Parnell and G. Butcher, Firecheck Consultants, Tonbridge, Kent, UK

D. Woolley, P. Fardell, J. Rowley, S. Rogers, R. Colwell, R. Mallows, D. Smit, and S. Vollam, BRE/FRS, UK

M. K. James, M. Cardona, J. Walnock and D. Benson, DuPont, Wilmington, Del., USA

E. Champney, EC Associates, Wilmington, Del., USA

R. Gottwald, SPI, Washington, DC

* Following this work certain AT&T personnel have become associated with Lucent Technologies.

Figure 1 BRE/FRS Full-Scale Test Rig

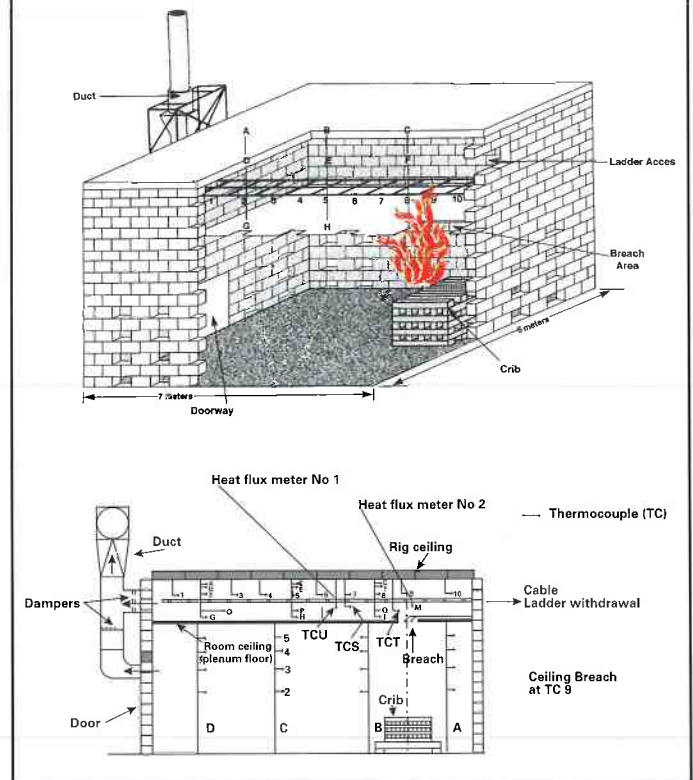

Figure 2 Full-Scale Fire Test at BRE/FRS

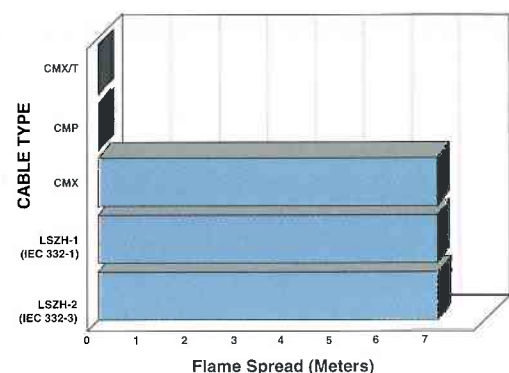

Figure 3
Full-Scale Fire Test at BRE/FRS

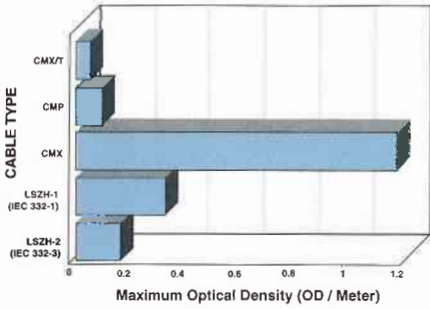

Figure 7
Steiner Tunnel Test

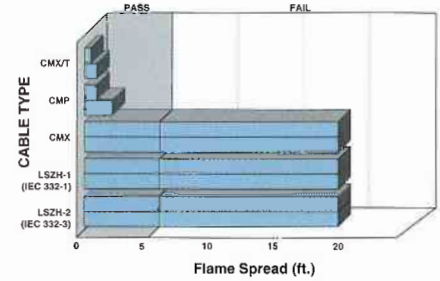

Figure 4
Full-Scale Fire Test at BRE/FRS

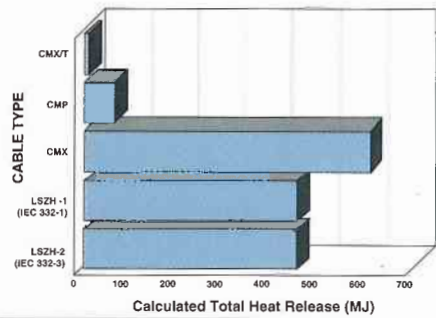

Figure 8
Steiner Tunnel Test

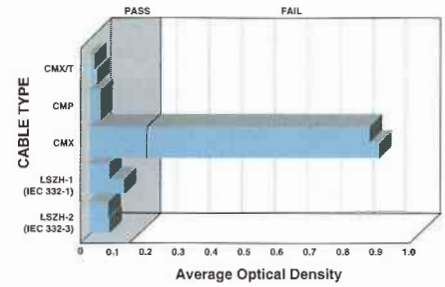

Figure 5

CMP Cable in Full-Scale Carbon Monoxide Tests at BRE/FRS

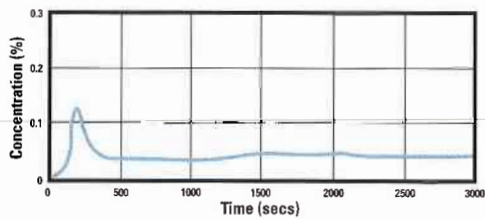

Figure 9
Steiner Tunnel Test

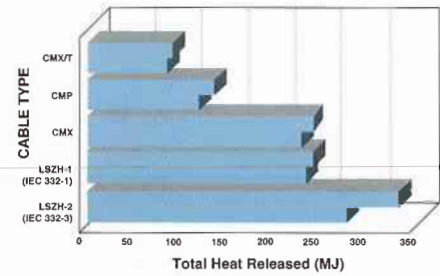

Figure 6

LSZH (IEC 332-1) in Full-Scale Carbon Monoxide Tests at BRE/FRS

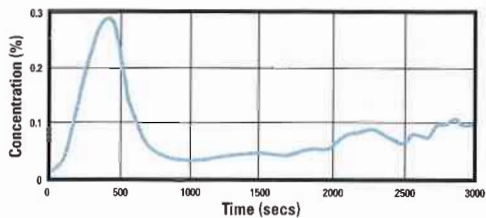

Figure 10

BRE/FRS Full-Scale Test Rig (side view)



Figure 11

BRE/FRS Full-Scale Test Rig at (front view)



Figure 13

Wood Crib 10 Minutes After Ignition



Figure 12

**Wood Crib on Load Cell with
Thermocouple Trees on Either Side**



Figure 14

**LSZH Cable Fire with Fire-Ball
on Ladder and Pool Fire
on the Suspended Ceiling Tiles**



Figure 15

**LSZH Cable Fires on Ladder in Overhead
Concealed Space at BRE/FRS**



Figure 16

**LSZH Cable Fires on Ladder in Overhead Concealed Space
(Flame Spread Along Ladder)**

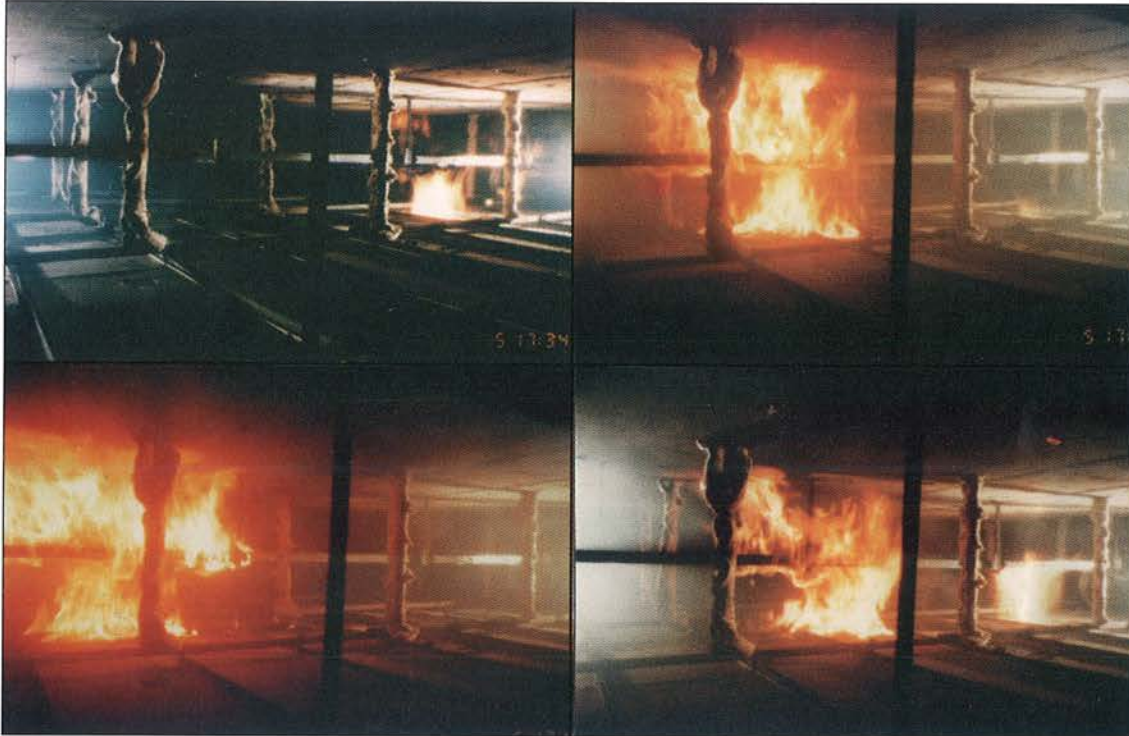

Figure 17

**CMP Cable on Ladder in Overhead Concealed Space
(No Flame Spread Along Ladder)**

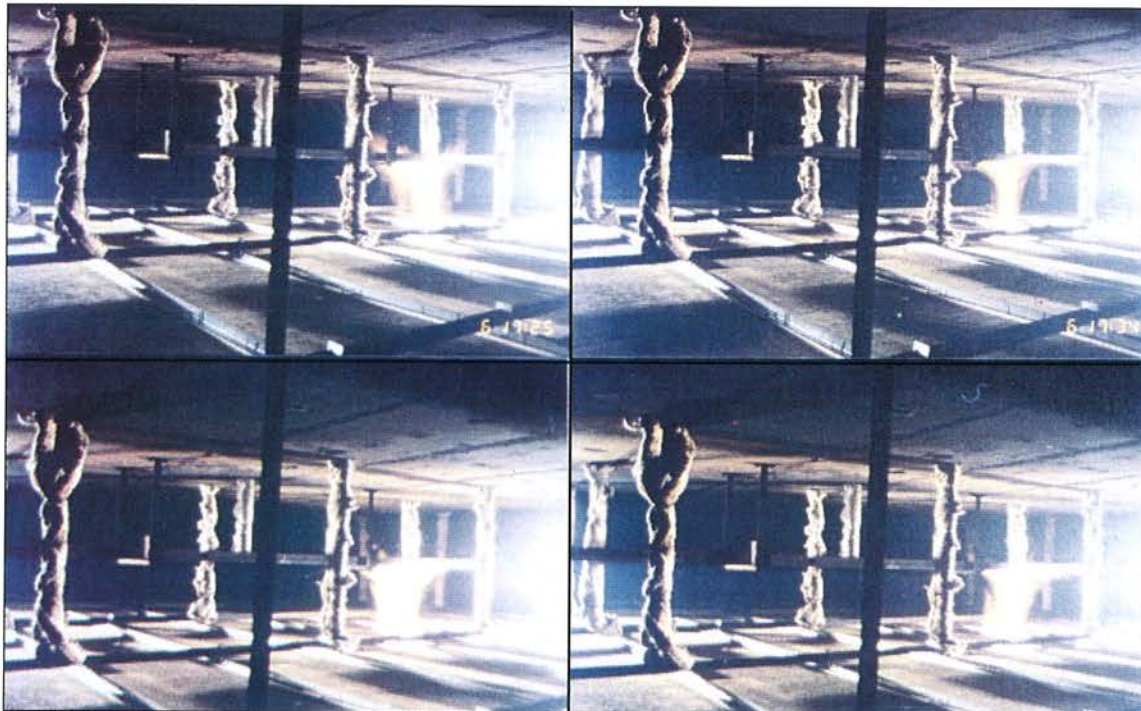

Figure 18

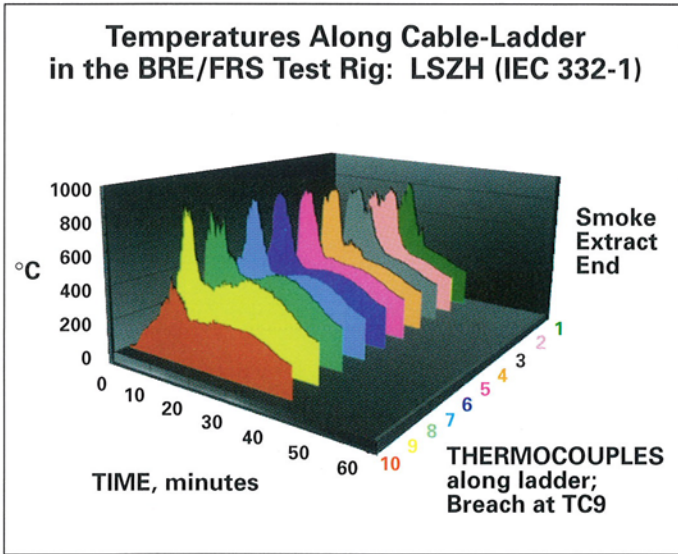

Figure 19

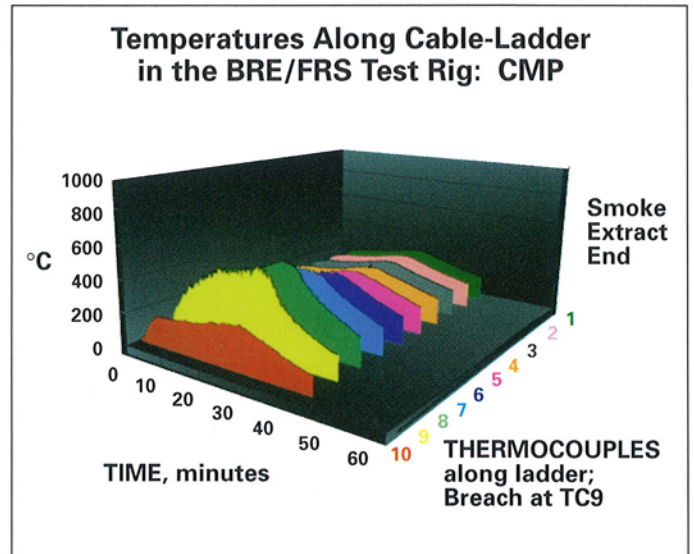

Figure 20

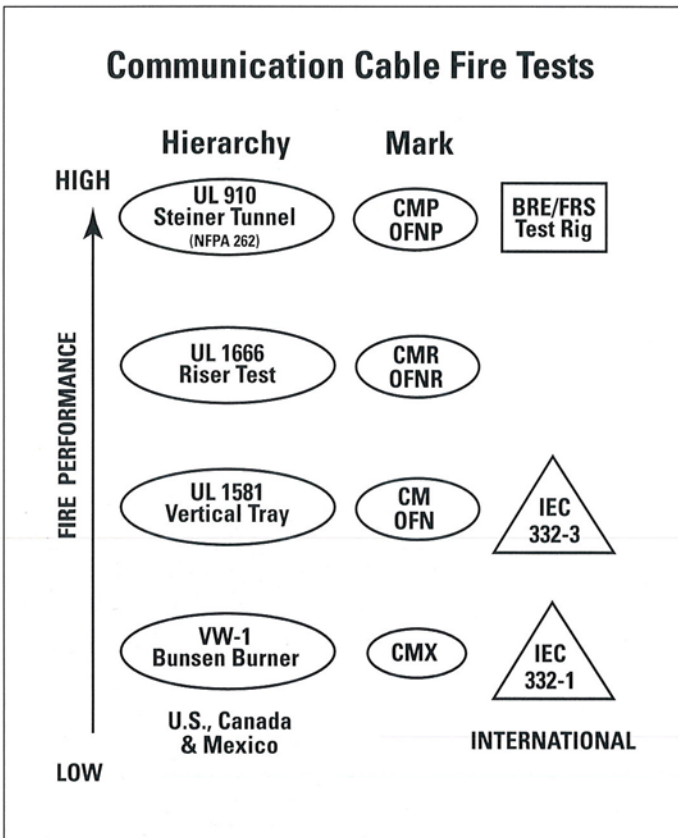

Figure 21

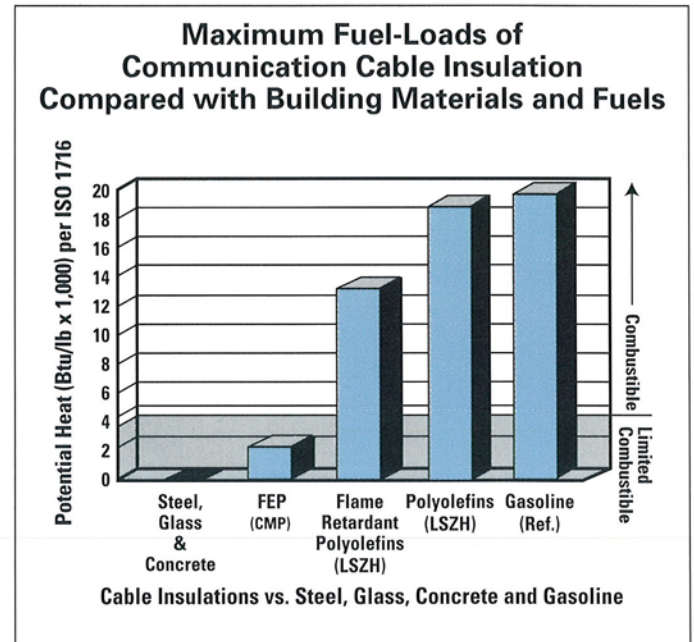
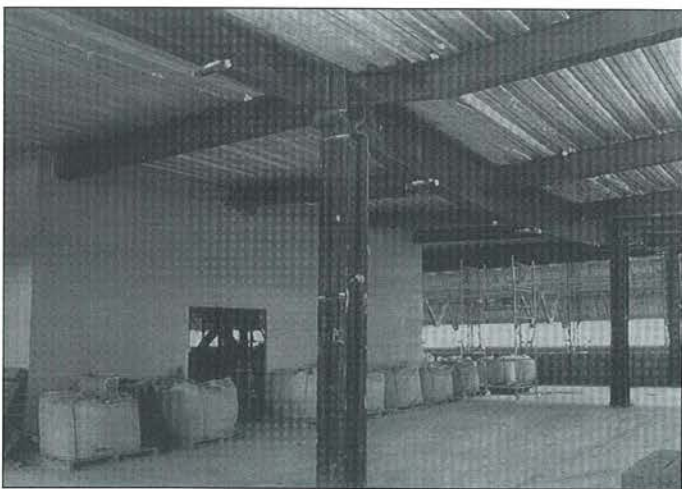
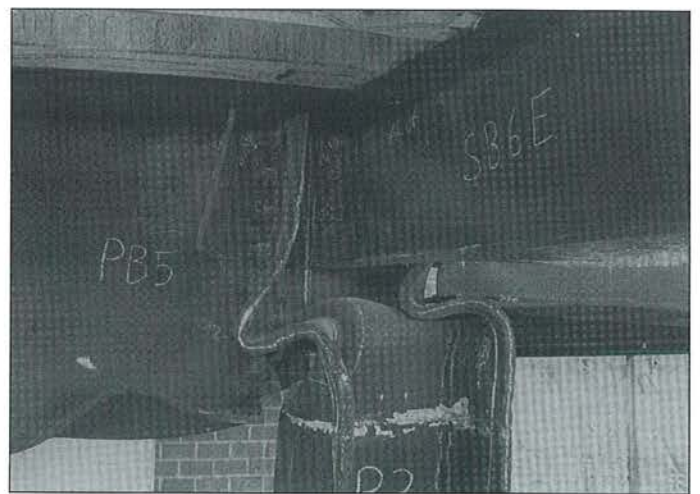

Figure 22

British Steel Technical *Fire Test Programme*
on 8-story Steel Test Rig at BRE/FRS Cardington, UK



General view of the steel frame after
the fire test (820°C beam temperatures)



Gross deformation around steel beam/
column connection
(enlarged from photo on left)

Figure 23

Tube Furnace Test Explosions with LSZH Cable Insulation

Frame 1* - Smoke-box (right) fills with dense dark smoke; spontaneous autoignition occurs in the tube furnace; fire-ball accelerates through connecting glass tube (left-to-right).

Tube Furnace Connecting Glass Tube Smoke-box



Frame 2* - Fire-ball exiting glass tube ignites primary explosion in smoke-box (exhibiting total flashover milli-seconds later).

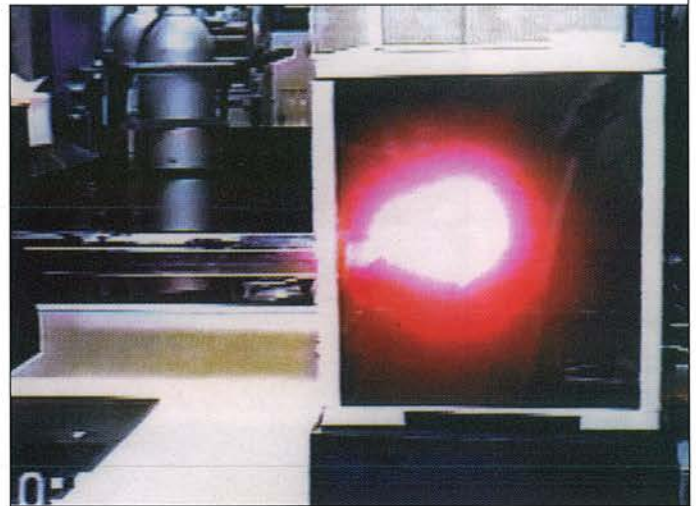

Frame 3* - A spontaneous secondary explosion occurs in the upper third of the smoke-box and blows the lid totally off.

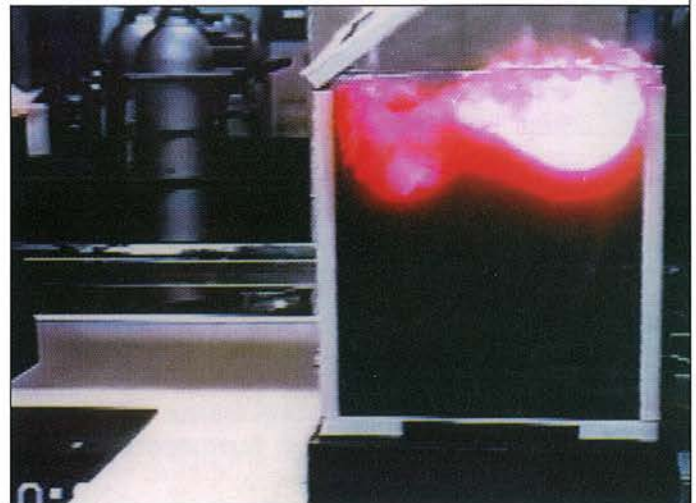

*Photos taken from freeze frame video.

Figure 24

Combustion Toxicity Data Per New York State (NYS)/
National Electrical Manufacturers Association (NEMA)

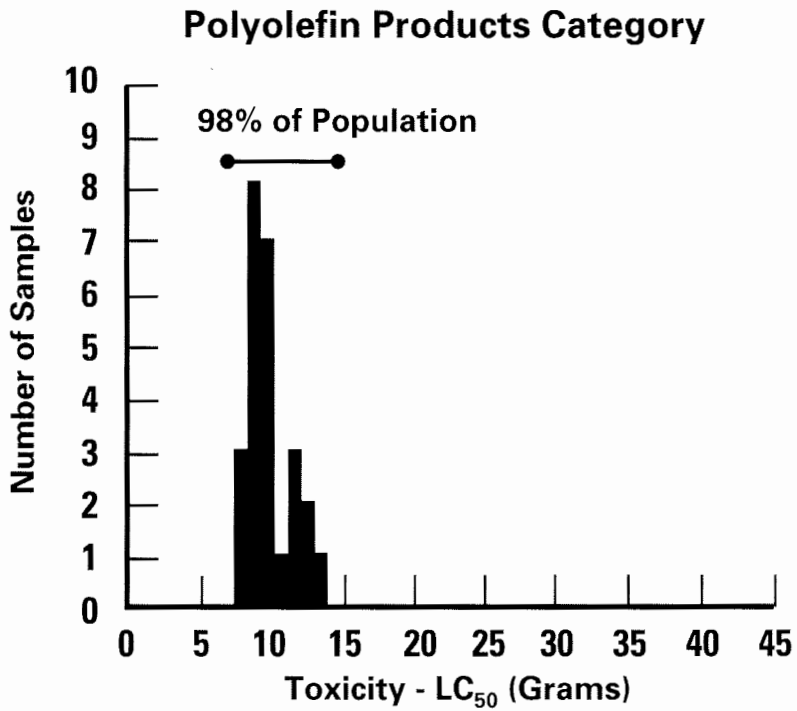
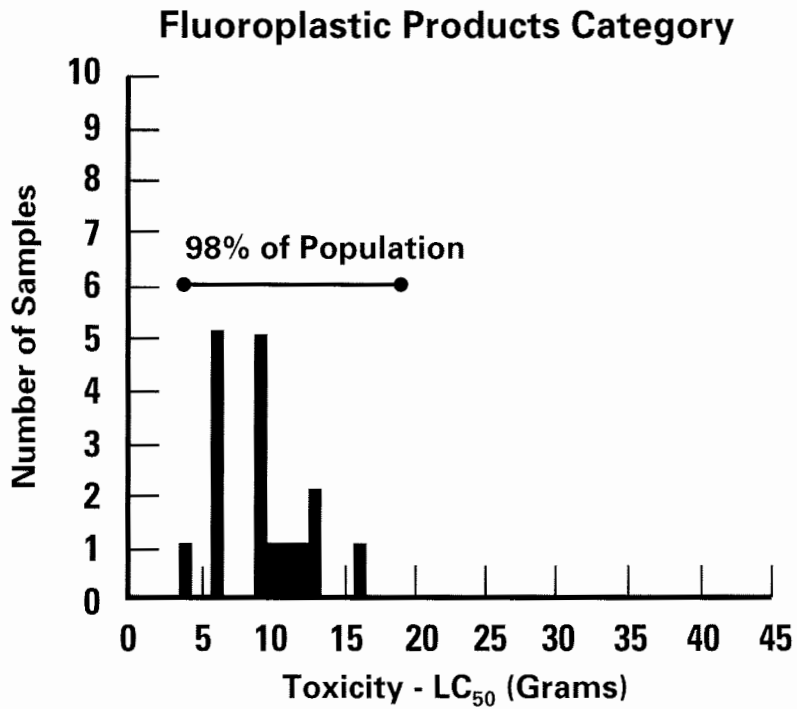

Figure 24a

Combustion Toxicity Data Per New York State (NYS)/
National Electrical Manufacturers Association (NEMA)

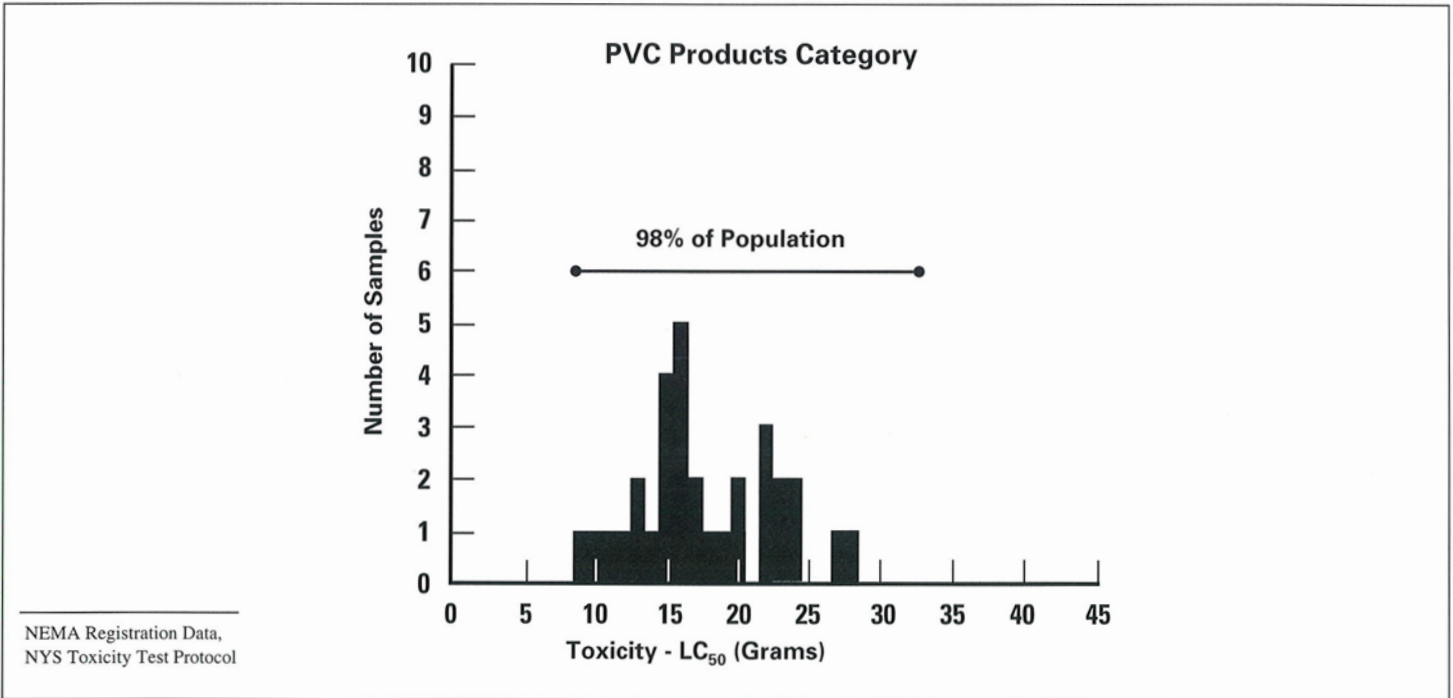

Figure 25

Typical UK Cable Installations

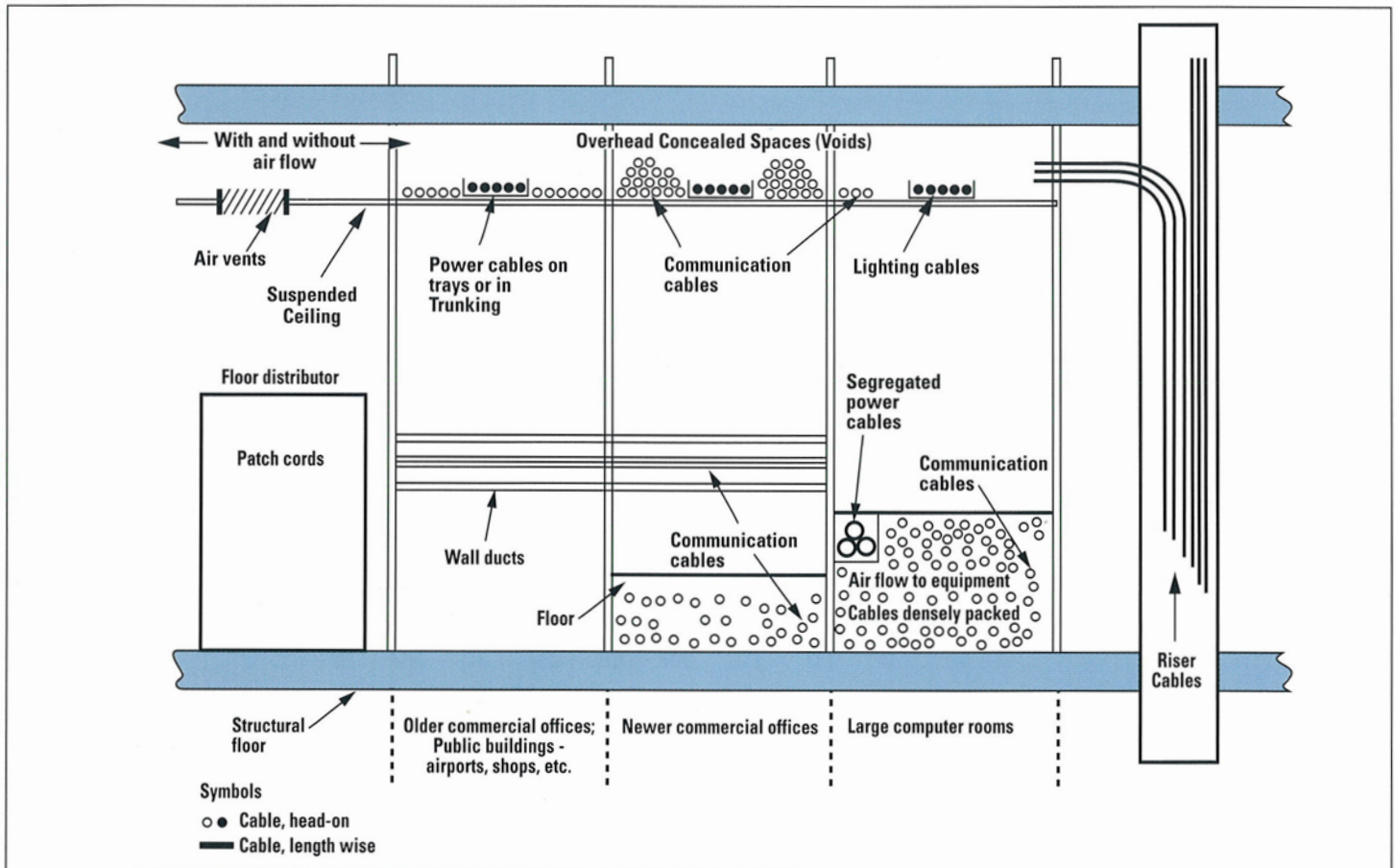

Figure 26
Frequently Occurring Fire Spread Routes

(Ref: ISO TC 92 SC4 Fire Safety Engineering)

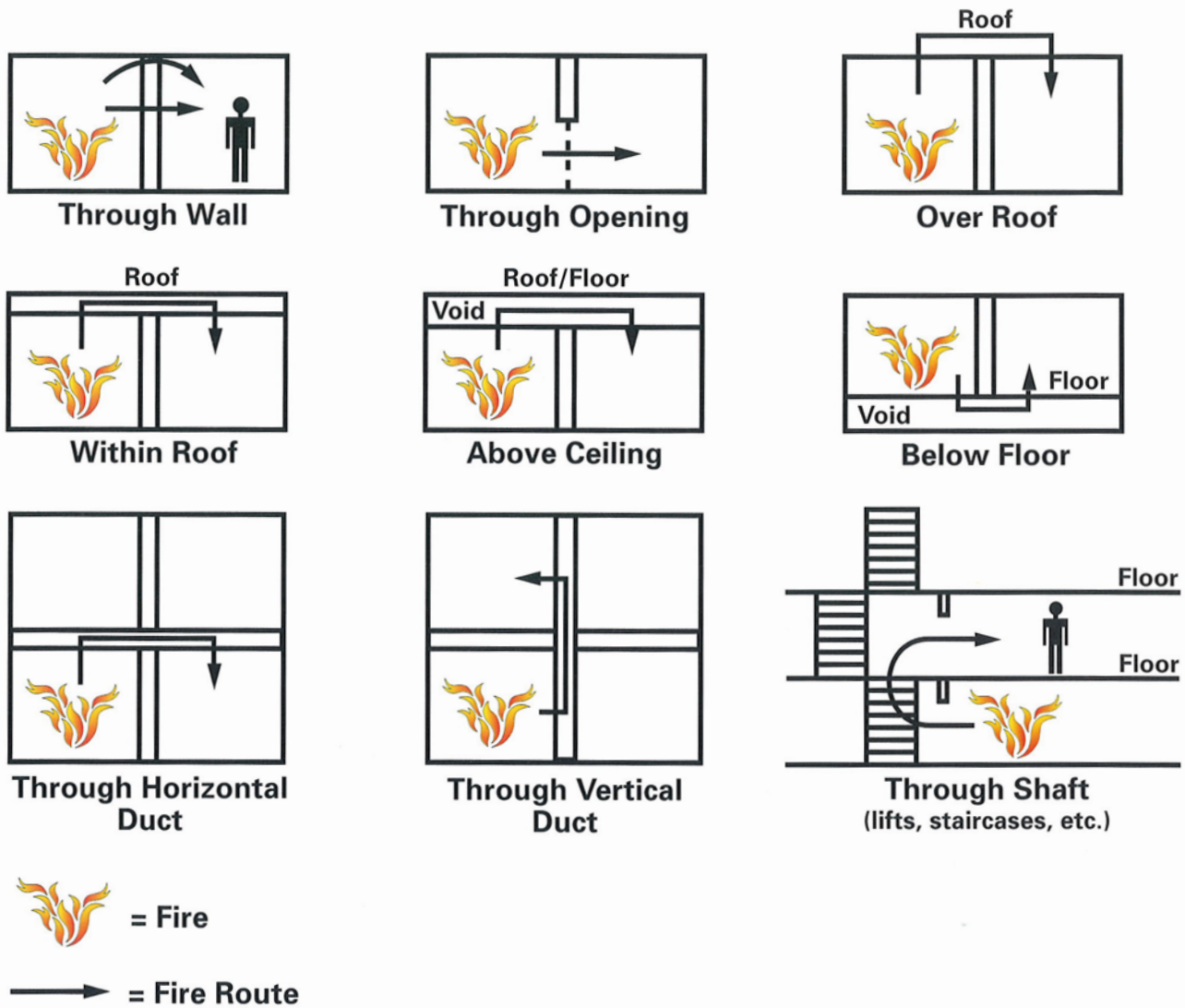

Figure 27
Comparison of Fire Test Standards

IEC	CENELEC (Equivalent)	USA NEC (Similar)	Use
332, Part 1	HD 405.1	CMX	Residential
332, Part 2	HD 405.2	CMX	Residential
332, Part 3C	HD 405.3C	CM/OFN	Industrial (GP)
none	none	CMR/OFNR	Riser
none	none	CMP/OFNP	Plenum

DuPont (U.K.)

DuPont (U.K.) Limited
Maylands Avenue
GB-Hemel Hempstead
Herts. HP2 7DP
Tel. (01442) 21 85 00
Telex. 825 713 DUPONT G
Telefax (01442) 24 94 63

Lucent Technologies (U.K.)

Lucent Technologies
Global Commercial Markets
101 Wigmore St.
London WIH 9AB
44-171-647-8126

BICC (U.K.)

BICC Brand-Rex Limited
Viewfield Industrial Estate
Glenrothes
Fife KY6 2RS
Scotland

The information set forth herein is furnished free of charge and is based on technical data that is believed to be reliable. It is intended for use by persons having technical skill, at their own discretion and risk. The handling precaution information contained herein is given with the understanding that those using it will satisfy themselves that their particular conditions of use present no health or safety hazards. Because conditions of product use are outside our control, we make no warranties, express or implied, and assume no liability in connection with any use of this information. As with any material, evaluation of any compound under end-use conditions prior to specification is essential. Nothing herein is to be taken as a license to operate under recommendation to infringe any patents.

MACHFORCE HIGH-SPEED MODULE TECHNICAL ARTICLE

High-speed data solutions and components are a growing requirement in the aerospace and defense industry. Modern systems are requiring higher data transfer speeds for mission-critical operations in harsh environments. The MACHFORCE® connector offers a highly dense 10G D38999 style solution with 10 Ethernet ports for applications transferring large quantities of data in rugged environments. To offer this density and address potential issues of signal integrity with 10 Ethernet ports, the MACHFORCE integrates an innovative High-Speed Module (HSM) designed specifically with impedance control and data pair isolation in mind. When paired with a high-performance Ethernet cable, these design attributes of the HSM enable optimized electrical performance with multiple disconnects.

Impedance Control with the High-Speed Module

To ensure 10G Ethernet performance the impedance of each twisted pair must be maintained. If a pair's twist is altered, the impedance is negatively impacted and the electrical signal will be disrupted causing system application issues. The MACHFORCE HSM is designed to enable the placement of all ten twisted pairs in individual grooves to protect the twists up through the crimped contact. In addition, the HSM's dielectric is manufactured with liquid crystal polymer (LCP) because it is a robust electrical conductor that maintains the impedance between the cable and contact.

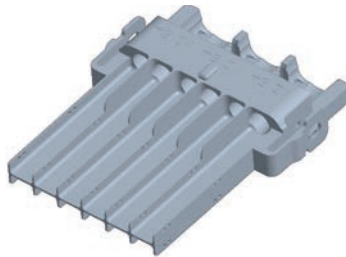

Figure 1: High-Speed Module Grooves

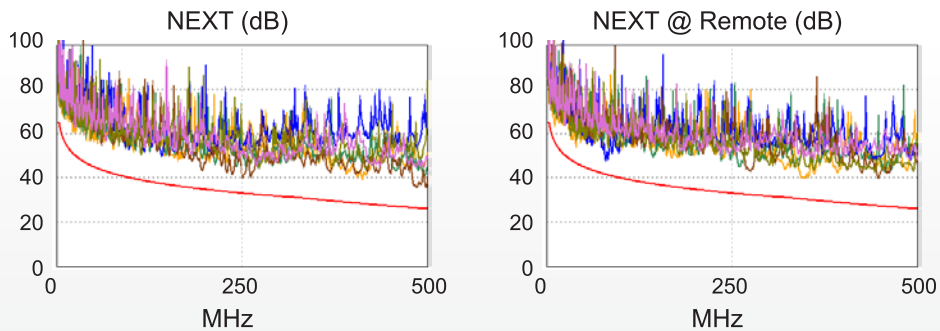

Figure 2: E6A6824 Near End Cross Talk (NEXT)

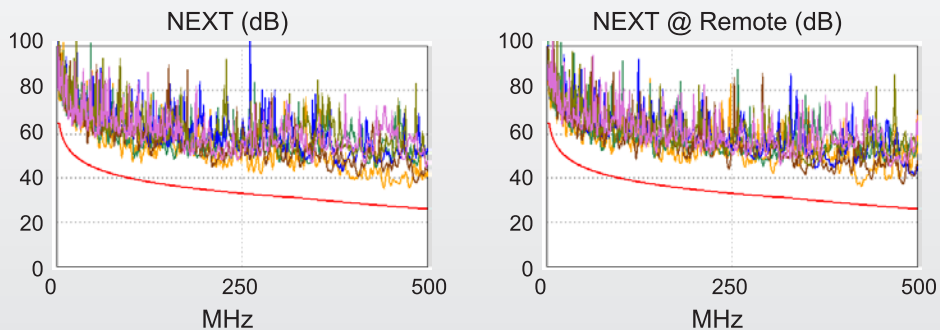

Figure 3: E6A6826 Near End Cross Talk (NEXT)

MACHFORCE HIGH-SPEED MODULE TECHNICAL ARTICLE

Data Pair Isolation with the High-Speed Module

With ten 10G Ethernet cables in close proximity, it is essential that the twisted pairs are properly isolated in order to protect signal integrity. The HSM is designed with fins to separate twisted pairs and reduce crosstalk. In addition, the HSM body is made of aluminum, a material that naturally reduces the electromagnetic waves emitted from the twisted pairs that cause signal interference. The aluminum fins are an essential part of the rectangular HSM design, allowing for twisted pairs to be packed in closer to maximize shell data density with ten ports while protecting signal integrity and application performance.

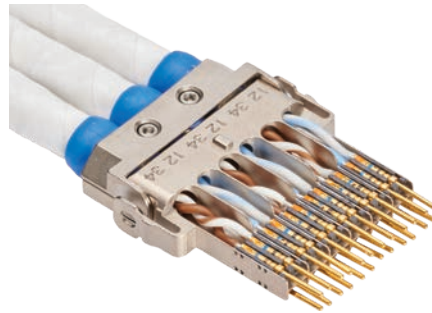

Figure 4: High-Speed Module Fins

Shielded 10G Ethernet Cable Solutions with the High-Speed Module

MACHFORCE has been tested and qualified for use with PIC Wire & Cable's DataMATES 10G Ethernet cables. The E6A6824 and E6A6826 CAT6a cables offer a shielding design that minimizes crosstalk between twisted pairs. Each cable features both silver-plated copper braided shielding and foil shielding to reduce the electromagnetic waves that are emitted from the pairs. To reduce signal interference, the incorporation of innovative design features in these cables and the HSM ultimately allows for optimized electrical performance that can extend long distances and over multiple connection breaks.

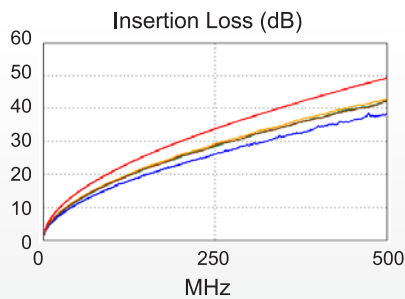

Figure 5: E6A6824 Insertion Loss

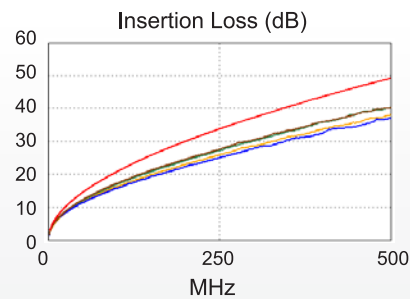

Figure 6: E6A6826 Insertion Loss

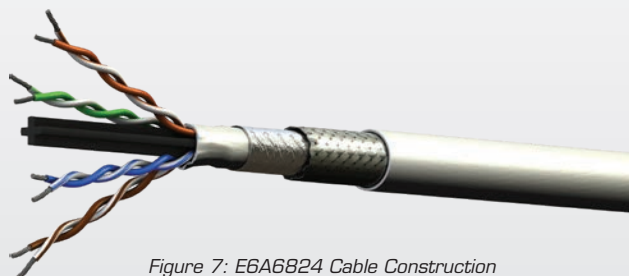

Figure 7: E6A6824 Cable Construction

ETHERNET CABLE CLASSIFICATIONS

TECHNICAL ARTICLE

Demand for Higher Bandwidth Drives New Ethernet Standards

The development of new data communications systems in the aerospace and defense industry is driving the need for more bandwidth. Ethernet standards have evolved to meet the data transfer rate and frequency requirements for these modern systems. Ethernet cables are used in a wide variety of aircraft, ground vehicle and mobile communications shelter applications, including ethernet backbones, avionics networks, in-flight connectivity, navigation systems and digital video. These mission critical systems are often installed in rugged and harsh environments that make signal integrity and system performance a challenge.

To address these performance requirements, PIC Wire & Cable offers a portfolio of CAT5e, CAT6a and CAT7 ethernet cables that transmit up to 10G of data at 600MHz with low loss, lightweight and flexible characteristics for applications that require robust, space saving and easily routable cables.

Ethernet Classifications: Pairing Data Applications with Cables

There are two main organizations that establish ethernet classifications: Telecommunications Industry Association (TIA) and International Organization for Standardization (ISO). Ethernet classifications are primarily established based on system frequency and data transfer speed.

To specify the correct ethernet cable for an application and ensure proper performance, the system's frequency and data speed requirements must be considered first. Once these requirements are identified, choose the ethernet classification that is the best match for the application's needs.

Ethernet Cable Classification

System Requirements		Classification		
Frequency	Data Transfer Speed	TIA (Cabling/Components)	ISO (Cabling)	ISO (Components)
1-100 MHz	1000 Base-T	Category 5e	Category 5e	Class D
1-250 MHz	1000 Base-T	Category 6	Category 6	Class E
1-500 MHz	10G Base-T	Category 6a	Category 6a	Class Ea
1-600 MHz	10G Base-T	N/A	Category 7	Class F

After identifying the classification best suited for the application, consider other cable characteristics that may impact the system's performance in a rugged environment:

- Flexibility
- Durability
- Length requirement

ETHERNET CABLE CLASSIFICATIONS

TECHNICAL ARTICLE

Ethernet Cable Construction: System and Environmental Performance

Ethernet cables that are designed to pass high data transfer rates at high frequencies run an increased risk of experiencing crosstalk, or wire pair to pair signal interference. Cables with crosstalk issues reduce signal integrity and negatively impact system performance.

To reduce the amount of crosstalk and increase the cable's max distance, PIC Wire & Cable's CAT5e and CAT6a cables feature a center spline to separate the wire pairs and reduce potential signal interference. The CAT6a wire pairs undergo additional twisting to further reduce crosstalk since the cable transfers more data at higher frequencies.

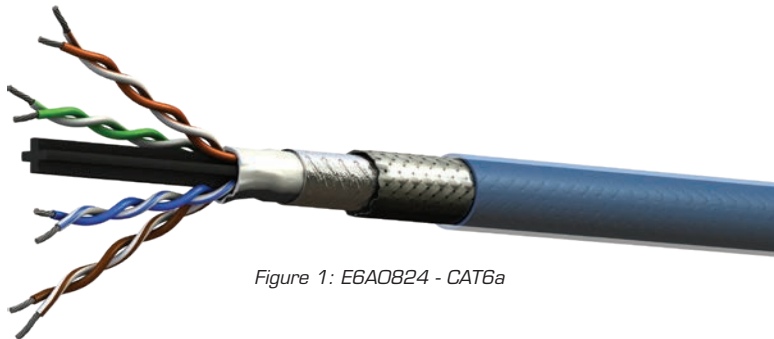

Figure 1: E6A0824 - CAT6a

PIC Wire & Cable's CAT7 cables perform at 10G speeds at even higher frequencies than CAT6a by individually shielding all pairs. The individual shielding significantly reduces crosstalk, increases max distance and protects signal integrity, which also makes CAT7 cables reliable solutions for low skew video applications.



Figure 2: E74824 - CAT7

Cable jacket options include ETFE and PTFE tape. ETFE jackets are rugged and designed for harsh environments that require a more durable solution. PTFE tape jackets are optimized for applications that require lightweight, flexible solutions in small, tight environments. Jackets are also laser markable for clear labeling and easy identification.

EWIS testing is conducted on all data cables to ensure high system and environmental performance. Tests performed include jacket blocking, thermal shock, abrasion, shrinkage and cold bend. Data cables also passed the minimum bend radius per channel requirements.

Ethernet Connectors and Assemblies

Pairing DataMATES ethernet cables and connectors provides a robust interconnect solution by optimizing data transmission, electrical performance and reliability. PIC Wire & Cable offers a wide variety of RJ45 connectors to support different applications.

Proper cable assembly is critical to optimizing the full benefits of interconnect technology. PIC Wire & Cable's assembly facility provides certified and tested assembly sets to simplify the system installation process. Pre-engineered assembly drawings are available to streamline the procurement process and simplify the US Federal Aviation Administration (FAA) submission process for modifications and installations.

AIRCRAFT USB CABLE SOLUTIONS

TECHNICAL ARTICLE

Solving Industry Demand for Faster USB Data Cables

In the aerospace and defense industry, the widespread usage of data networks has driven more demand for high speed USB cables. Universal Serial Bus (USB) cables are a popular data solution because of its unique ability to transfer both power and data. USB is optimized for a variety of demanding applications for aircraft, mobile shelters and ground vehicles, including in-flight connectivity, data transfer, high definition video and IP cameras.

As new technologies develop and additional applications are identified, the requirement for increased data speeds have challenged interconnect engineers with building faster cables capable of being used at higher frequencies in more rugged environments. To accommodate the trend towards higher frequencies and faster speeds, the market is moving from USB 2.0 towards USB 3.1, which transmits 20x more data.

PIC Wire & Cable offers a portfolio of high speed DataMATES USB 2.0 and 3.1 cables that are designed to meet the standard's data requirements and are robust solutions for applications requiring low loss, lightweight and flexible cables.

USB Standard Evolution: Data Cable Speeds

Universal Serial Bus (USB) is an industry standard that specifies the data speed requirements for USB 2.0 and 3.1 cables, which are the two most widely used USB cables in the aerospace and defense industry. The USB 2.0 standard requires a data transfer speed of 480 Mbps, which is used primarily for data transfer and device charging. In response to the increasing demand for faster data speeds, the USB 3.0 standard (renamed USB 3.1 - Gen 1) was created and requires a data transfer rate of 5 Gbps and is 10x faster than USB 2.0. With a demand for even faster cables, the USB 3.1 - Gen 2 standard was established and requires a data transfer rate of 10 Gbps, which is 20x faster than USB 2.0 and supports more advanced high definition video and in-flight entertainment applications. USB 3.1 - Gen 2 is backwards compatible with USB 3.1 - Gen 1 and USB 2.0.

Standard	USB Name	Data Transfer Speed
USB 2.0	High Speed USB	480 Mbps
USB 3.0/USB 3.1 – Gen 1	SuperSpeed USB	5 Gbps
USB 3.1 - Gen 2	SuperSpeed Plus USB	10 Gbps

PIC Wire & Cable's DataMATES USB aircraft cables are designed to meet USB 2.0 and 3.1 specification requirements and are leading market solutions for low loss, lightweight cables capable of operating at high frequencies in rugged environments.

Part Number	Data Transfer Speed	Loss dB/1 m	Weight lbs/100 ft (kg/100 m)
USB2422	480 Mbps (USB 2.0)	@ 200 MHz: 10.5 @ 400 MHz: 15.9	2.4 (3.6)
USB2624	480 Mbps (USB 2.0)	@ 200 MHz: 12.8 @ 400 MHz: 18.2	2.2 (3.3)
USB3-2624	10 Gbps (USB 3.1 - Gen 2)	@ 5.0 GHz: 3.38 @ 7.5 GHz: 4.60	3.4 (5.1)
USB3-2624-9	10 Gbps (USB 3.1 - Gen 2)	@ 5.0 GHz: 3.38 @ 7.5 GHz: 4.60	3.6 (5.4)

AIRCRAFT USB CABLE SOLUTIONS

TECHNICAL ARTICLE

USB Data Cable Construction

PIC Wire & Cable's USB 2.0 cables are designed for 480 Mbps applications. The cable includes one data pair with a 100% foil shield and 80% braided shield that provides robust protection against EMI to ensure signal integrity. Laser markable jacket options include a robust ETFE or light and flexible PTFE tape. USB 2.0 cables are Skydrol resistant, RoHS compliant, and meet or exceed EIA-364-XX and FAA flammability requirements FAR Part 23 and 25, Appendix F.



Figure 1: USB2624 (USB 2.0)

For faster data requirements, PIC Wire & Cable's USB 3.1 cables are designed for 10 Gbps high speed applications. USB 3.1 cables achieve 20x the speed of USB 2.0 cables by adding two high speed data pairs, for a total of three data pairs, to the construction. The tightly twisted, highly shielded pairs (100% foil and 80% braided shields) minimize signal interference and allow the cable to operate at higher frequencies than USB 2.0. Laser markable jacket options include a robust ETFE or light and flexible PTFE tape. USB 3.1 cables are Skydrol resistant, RoHS compliant and meet the FAA flammability requirements of FAR Part 23 and 25, Appendix F.

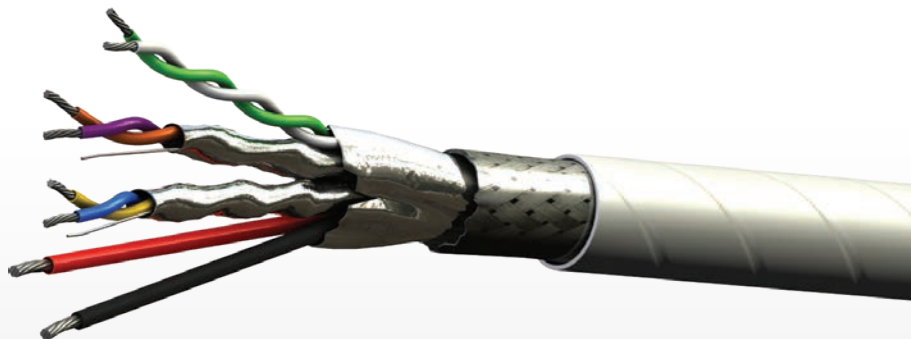

Figure 2: USB3-2624 (USB 3.1)

USB Connectors and Assemblies

Pairing DataMATES USB cables and connectors provides a robust interconnect solution by optimizing data transmission, electrical performance and reliability. PIC Wire & Cable offers several types of USB connectors to support different applications, including Type A, Type B and Micro-B.

Proper cable assembly is critical to optimizing the full benefits of interconnect technology. PIC Wire & Cable's assembly facility provides tested assembly sets to simplify the system installation process. Pre-engineered assembly drawings are available to streamline the procurement process and simplify the US Federal Aviation Administration (FAA) submission process for modifications and installations.

3G-SDI CABLE SOLUTIONS TECHNICAL ARTICLE

3G-SDI System Applications

Technological improvements in video systems have made high definition cameras and displays popular and their integration widespread. 3G-SDI systems are used in aerospace, ground vehicles, shipboards, and surveillance applications, and are important for many people to do their job effectively. These high definition video systems are often installed in harsh environments with high temperature variance, intense vibrations, various cable run lengths, and electrical noise. When designing system integration, choosing the proper cable is critical. The main factors to consider when choosing a cable for a 3G-SDI system include:

- Cable loss
- Cable shielding effectiveness
- Ease of termination
- Cable/connector impedance

System Integration Obstacles: Outdated Coaxial Cable Options

3G-SDI systems require higher frequencies to operate, making component engineers' interconnect cable choices critical for proper system operation. The military spec cable RG179 is frequently used for 3G-SDI systems, but is outdated and was originally designed to serve analog, not digital, applications. RG179's delicate cable construction results in poor shielding, high loss numbers, and difficult termination, which disrupts system operation and can cause countless hours of troubleshooting and rework.

Solution: Specify PIC Wire & Cable® VideoMATES V73263

Rugged cable construction is critical for proper system integration and operation, and needs to account for cable path, run length, number of disconnects and environmental electrical noise. In addition, it needs to maintain its geometrical integrity when bent or flexed. PIC's VideoMATES V73263 cable is a robust solution for 3G-SDI systems and meets PIC's rigorous manufacturing process and quality controls. Its rugged construction maximizes shielding effectiveness and termination ease, and minimizes cable loss while matching cable and connector impedance. Overall, V73263 makes building, installing, maintaining, and troubleshooting assemblies less time-consuming with its physical properties, electrical characteristics and laser markable jacket.

To demonstrate V73263 is a superior solution to RG179 in 3G-SDI applications, this article will directly compare the two cables against the four main factors commonly considered in cable choice decisions: loss, shielding, ease of termination and cable/connector impedance.

3G-SDI CABLE SOLUTIONS TECHNICAL ARTICLE

Loss

Per 3G-SDI standards, most receivers require < 20 dB of loss at 1.5 GHz to operate correctly. At 20ft, the loss for RG179 is 6.59dB, while 4.44dB for V73263. The maximum run length of RG179 is about 60', compared to 85' with V73263. Lower loss numbers with V73263 allow system integrators more flexibility where the cable is ran and where system components are installed. The greater head room in shorter lengths also gives the integrator room for minor errors made in termination or installation that may affect the cable's performance.

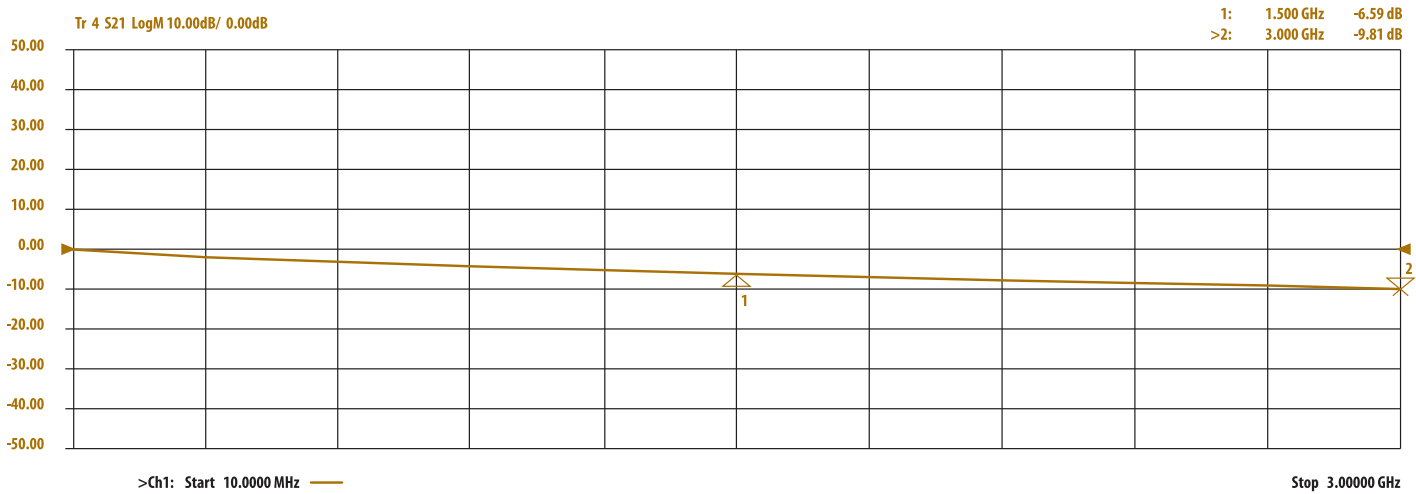

Figure 1a: RG179 Loss at 20 ft



Figure 1b: V73263 Loss at 20 ft

3G-SDI CABLE SOLUTIONS TECHNICAL ARTICLE

Shielding

Choosing a cable with proper shielding is critical to reducing electrical noise, by containing electrical energy inside the cable and preventing outside signal interference. Poor shielding will result in cable signal disruption and prevent the system from operating correctly. V73263 has a flat, helical strip and a round braid that provides 100% coverage. This construction achieves -110dB of shielding effectiveness. In contrast, RG179 only provides -50dB with 1 round braid.



Figure 2a: RG179 cable construction



Figure 2b: V73263 cable construction

Termination

Ease of termination is often an undervalued cable quality until an issue arises. RG179 has a solid dielectric and 30AWG center conductor, which is difficult to cut without compromising the cable's electrical integrity. V73263 addresses this issue by using a foam dielectric and 26AWG center conductor to simplify the cutting and pinning process. Its center conductor's tensile strength is almost double that of RG179 at 8.1lbs compared to 4.4lbs. V73263 has a foam dielectric that simplifies the termination process by allowing technicians more control over removing the dielectric without cutting the center conductor. In addition, its larger center conductor size provides a larger surface area to terminate the contact.

Connector Impedance

For maximum system effectiveness, the dimensions and impedance of a cable and connector must match. PIC connectors meet or exceed 3G-SDI frequencies of 3GHz, and are offered in a variety of styles for V73263, including ARINC, M39039, and M39012. PIC designs connectors to perfectly match its cables, minimizing the amount of loss or reflections, and ensuring the proper delivery of a signal. For example, since the Mil-Spec size 8 contacts do not have a 75 ohm interface, PIC changed the center pin size to achieve a 75 ohm interface.

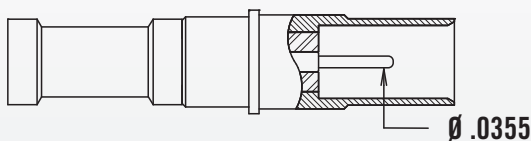

Figure 3a: M39029 Size 8 50 ohm contact

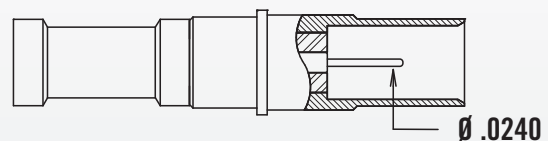

Figure 3b: PIC's M39029 Size 8 75 ohm contact

Rising Industry Demand for Lightweight Cable Technology

Aerospace engineers are consistently being challenged to design lighter aircraft. Saving weight is a top priority in both forward-fit and retrofit designs to reduce materials and fuel costs, while increasing payload. One major way to save aircraft weight is by installing lightweight cables. PIC Wire and Cable® has designed a line of lightweight cables that address industry demands for weight-saving technology and its requirement for high performance, reliable interconnects. RFMATES ULTRALITE is an extension of its 50 ohm RF coaxial RFMATES cable line and engineered to provide significant cable weight savings.

RFMATES ULTRALITE cables offer a robust solution for a variety of advanced electronic applications:

- Communications: Satcom, Iridium, Cellular, VHF, UHF and HF
- Navigation: GPS, Radio Altimeter, DME, VOR and Marker Beacon
- Collision Avoidance: ADS-B, TCAS, TAS, ACAS and Skywatch

RFMATES ULTRALITES Save Aircraft Cable Weight

The RFMATES ULTRALITE family has been rapidly adopted by major aircraft and avionics OEMs in response to the rising industry demand for weight saving cables. These lightweight, flexible cables offer significant weight savings over competitor and RG cables:

- PIC UH25107 is 81% lighter than RG211
- PIC UH67163 is 80% lighter than RG393
- PIC UH44193 is 56% lighter than RG142

In addition to weight savings, these cables are low loss solutions with high shielding effectiveness, and feature crush resistant VOP dielectrics and laser markable jackets.

Coaxial Cable	Conductor	Weight lbs/100 ft (kg/100 m)	Loss @ 1.0 GHz dB/100 ft (dB/100 m)	Bend Radius in (mm)	Cable O.D. in (mm)	Shielding Effectiveness (dB)
UH25107	8 AWG Solid SPCCA	12.0 (17.9)	2.8 (9.2)	2.50 (63.50)	0.445 (11.303)	-110
UH22089	10 AWG Solid SPCCA	7.2 (10.7)	3.5 (11.5)	1.70 (43.18)	0.345 (8.763)	-110
UH67163	14 AWG Solid SPCCA	3.4 (5.1)	6.2 (20.3)	1.20 (30.48)	0.227 (5.766)	-110
UH44193	19 AWG Solid SPCCS	1.9 (2.9)	10.4 (34.1)	0.80 (20.32)	0.152 (3.861)	-110
RG211	4 AWG Solid BC	64.1 (95.4)	4.5 (14.8)	3.60 (91.44)	0.730 (18.542)	-50
RG393	12 AWG Stranded SPC	17.5 (26.4)	7.7 (25.2)	1.95 (49.53)	0.390 (9.906)	-75
RG142	19 AWG Solid SPCCS	4.3 (6.4)	13.4 (44.0)	1.00 (25.40)	0.195 (4.953)	-75

Table 1: RFMATES ULTRALITE and RG Cable Comparison

50% Cable Weight Saved on Helicopter

A leading helicopter manufacturer asked PIC Wire & Cable to help find a solution to reduce coax cable weight on one of its airframes. Each helicopter used 809.1 feet of coax cable, and the manufacturer needed to reduce some of the 59.06 pounds of cable on the airframe. To reduce weight, RFMATES ULTRALITE cables were installed on the airframe and weighed only 28.82 pounds. Choosing RFMATES ULTRALITE cables reduced the helicopter's cable weight by 51% and saved 30.24 pounds.

Innovative Cable Construction

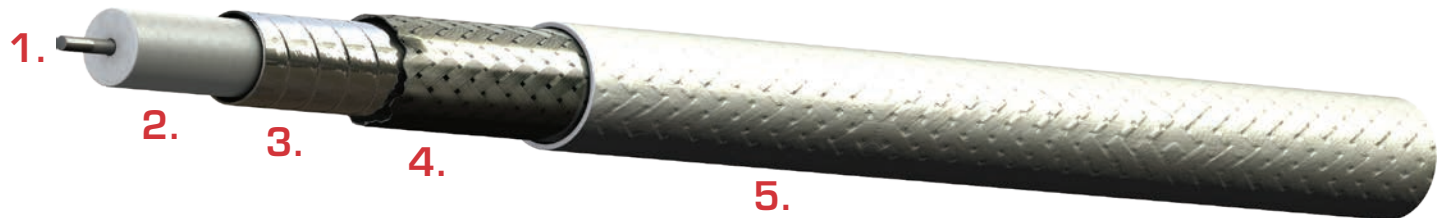

1. Conductor

UH67163, UH25107 and UH22089 use a Silver Plated Copper Clad Aluminum (SPCCA) conductor to increase weight savings. SPCCA conductors are 69% lighter compared to copper conductors of the same gauge. Based on its size, UH44193 uses a Silver Plated Copper Clad Steel. Steel conductors are 11% lighter compared to copper conductors of the same gauge.

2. Dielectric

RFMATES ULTRALITE cables use either an expanded extruded Polytetrafluoroethylene (PTFE) or tape wrapped PTFE dielectric. The dielectrics have a high Velocity of Propagation (VoP) which lowers the cable's insertion (dB) loss, while still maintaining a strong composition. This dielectric also saves weight and increases flexibility.

3. Inner Shield

RFMATES ULTRALITE cables use a Silver Plated Copper spiral (helically) wrapped shield. With this design, the -110 dB shielding effectiveness is the same as a semi-rigid coaxial cable (solid copper tube), such as RG405. This is significantly higher than the standard -75 dB for dual braided shields used in RG cables, and -90 dB for cables with a foil and outer braid shield. The spiral wrapped shield provides 100% coverage compared to flat braided shields. This shield design increases the cable's shielding effectiveness and lowers its dB loss.

4. Outer Braid

RFMATES ULTRALITE cables use a Silver Plated Copper Clad Aluminum (SPCCA) outer braid. This braid is designed to minimize dB loss and its lightweight material contributes to weight savings.

5. Outer Jacket

RFMATES ULTRALITE jackets are made of high temperature, white ethylene tetrafluoroethylene (ETFE). This material allows cables to be used and stored in high temperature environments. They are chemical resistant, abrasion resistant, and meet the FAA flammability requirements 14 CFR Part 25.869 (a)(4) Amdt 25-113 Appendix F Part 1 (a)(3). Each cable is also laser markable to streamline and simplify the labeling process.

RFMATES ULTRALITE Connectors

The RFMATES ULTRALITE family includes a variety of matching connectors, including a full line of M39012 style RF connectors. Pairing RFMATES ULTRALITE cables and connectors provides a robust interconnect solution by optimizing electrical performance and increases weight savings. The connectors also improve termination, installation, maintenance and reliability. To ensure proper field installation and termination, crimp die sets are available for the connectors. In addition, PIC Wire & Cable offers complete certified cable assemblies to streamline the installation process.

Tested Cable Reliability

RFMATES ULTRALITE cables and connectors passed rigorous EWIS testing. Our EWIS testing includes: Vibration, Shock, Thermal Shock, Aging Stability, Flammability, Smoke & Toxicity testing per Airbus AB0031 and many more tests to ensure the cables and connectors are robust enough for their rugged aerospace and defense applications. A concentrated load testing per MIL-T-81490 was conducted to demonstrate RFMATES ULTRALITE cables have better compressive resistance compared to similar sized cables. In addition, the RFMATES ULTRALITE line is Skydrol resistant, RoHS compliant, meets the FAA flammability requirements 14 CFR Part 25.869 (a)(4) Amdt 25-113 Appendix Part 1 (a)(3), and complies with MIL-C-17 as applicable. EWIS tests and qualification test reports are available by request.

TECHNICAL ARTICLE # 1

Like modern avionic instruments which are more sophisticated and sensitive (and capable) than in the past, modern coaxes with softer, lower-loss dielectrics are more easily damaged.

Bending, stretching, and kinks can force the center conductor to one side. This disturbs the common axis of the conductor and shield — they are no longer concentric — and shows up as a change in impedance at the point of "injury." This can actually be seen on a Time Domain Reflectometer (TDR), an instrument which examines cables for signal reflection, appearing as an electrical "bump" (or dip).

The penalty for mishandling comes in increased losses, reflection quirks and impedance mismatches — translating to higher VSWR (Voltage Standing Wave Ratio), and instability of other characteristics. Any of these can have a serious effect on overall system performance.

Bend Radius is relatively easy to visualize (see Figure 1). It is harder to estimate, though, because it is a radius, which by definition is a measurement with an imaginary reference point. Bend Radius can be critical to the installation of coaxial cables especially where the routing of the cable passes by or through structural elements where an edge may touch the cable. Under any amount of tension, this can make a "corner" in the cable which violates the bend radius limits.

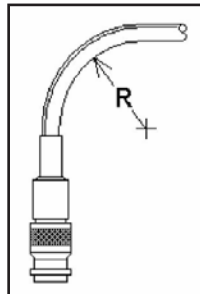

Figure 1. Bend radius

Too often the damage is invisible—an internal flaw caused by undue forces. Even though the Teflon® jacket on most coaxial cables used on aircraft today is tough and flexible, it can also hide such damage; all the more reason to use caution during installation.

To maintain published performance, each cable type has a recommended minimum bend radius. This is usually 5x the outer diameter of the cable, but may be specified as some other figure by the manufacturer. (See Table)

A technician needs to remember that physical force, while not always avoidable when making an installation, must be moderate. There are no "cable stretchers" in the tool catalogs.

The most easily damaged part of a cable is at the connector. Here the stiffness of the ferrule or clamp which holds the cable to the connector body encounters the flexibility of the cable itself. This is known as a "stress riser," an edge which concentrates the damaging force on the cable. In some cases, pulling the cable at a right angle to the axis of the connector ferrule can even damage the termination or the connector itself. Where the planned cable routing involves tight bends, it may be better to use a right angle connector or one of PIC's new 75° connectors.

A full-size template is incorporated in our RF Cable Guide, along with a lot of other useful data for RF coaxial cable applications. It is available on request.

PIC P/N	Cable Type	O.D.	Min. Bend Radius
COAXIAL			
S86208	50 ohm	0.130	0.65
S88207	50 ohm	0.130	0.65
S44191	50 ohm	0.195	1.00
S44193	50 ohm	0.195	1.00
S46191	50 ohm	0.195	1.00
S67163	50 ohm	0.230	1.20
S33141	50 ohm	0.270	1.40
S55122	50 ohm	0.310	1.55
S22089	50 ohm	0.435	2.50
V75268	75 ohm	0.122	0.60
V76261	75 ohm	0.123	0.64
TRIAxIAL			
L8620TX	50 ohm	0.173	0.85
L2201TX	50 ohm	0.245	1.25
MIL-C-17 P/N COAXIAL			
RG174	50 ohm	0.100	0.50
RG58	50 ohm	0.193	1.00
RG142	50 ohm	0.195	1.00
RG400	50 ohm	0.195	1.00
RG223	50 ohm	0.211	1.00
RG393	50 ohm	0.390	1.95
RG213	50 ohm	0.405	2.00
RG8	50 ohm	0.425	2.10
RG214	50 ohm	0.425	2.10
RG179	75 ohm	0.100	0.50
RG59	75 ohm	0.242	1.20

TECHNICAL ARTICLE #2

In theory, electrical signals move at the speed of light. Cables only slow them down. The ratio of actual speed to the speed of light is known as the velocity factor, or Velocity of Propagation (VOP), expressed as a percentage of the speed of light in free space.

This slowing effect is almost entirely caused by the dielectric material—in coaxial cables, the insulation between the shield and the center conductor. For a closed-cell foam dielectric, for example, the VOP may approach 90%, meaning that a signal will travel at 90% of the speed of light. For solid Teflon®, the VOP is typically about 70%.

(These figures can differ according to specific formulation of the material. They are also subject to variation depending on the construction of the cable.)

What effect does the VOP have? After all, 70% of the speed of light is still pretty fast! Fact is, in some avionic and other electronic applications, speed and delay are critical factors and need to be measured with precision.

The delay from one end of a cable to the other is inversely proportional to the VOP: the lower the VOP %, the longer the delay.

This can be important in relative signal timing for navigation systems, for example. Delay is independent of frequency. In effect, it is the defining factor of the electrical length of a wire or cable.

Published literature often lists delay among the characteristics of cable. If so, it's a simple matter to calculate the delay for a specific length of cable based on the "ns/ft" value. But it is also practical to calculate delay using the VOP and the following formula:

$$d = \frac{L}{(C \times VOP)}$$

...or, more practically,

$$d = \frac{1.016 \times L}{VOP}$$

where: d = Delay in nanoseconds
L = Length of the cable in feet
C = Velocity of light in free space
VOP is expressed in percent

As a guideline, Table 1 lists VOP, dielectric constant, and delay for some of the common cable dielectric materials, along with a few less common materials, included for your amusement. Table 2 carries this into PIC coaxes and a few RG types.

Delay is a critical factor in determining the bearing of transponder signals received by a directional TCAS antenna. But the figure of merit here is the absolute phase angle of the cable at the specified frequency.

Wavelength, Phase Matching & VOP

At microwave frequencies (TCAS and transponders operate near 1000 MHz), a single nanosecond (a billionth of a second) is an entire wavelength. TCAS II tolerates one such wavelength (360°) of mismatch among the four upper or lower directional antenna cables, and some TCAS I processors require even greater precision than that. Note that such phase matching requires not only that the waves coincide in pattern with one another from cable to cable but that they must do so within the very same wave. (See Figure 1.) Thus both phase and delay measurements are important.

Material	ε @ 1.0 GHz	VOP	DELAY
TYPICAL INSULATION MATERIALS			
Cellular TFR	1.38	85%	1.2
FEP	2.1	69%	1.47
Silicone	3.6-2.1	53-69%	1.92-1.47
TFE	2.1	69%	1.55
Polyethylene	2.3	66%	1.55
PVC	8.2-3.0	35-58%	2.9-1.75
Nylon	4.5-3.6	47-53%	2.16-1.92
NON-TYPICAL INSULATION MATERIALS*			
Snow (Fresh)	1.2	91%	1.1
Vaseline	2.2	68%	1.49
Beeswax	2.8	60%	1.69
Ice	3.2	56%	1.8
Glass	8.2-3.8	35-51%	2.9-2.0
Water (Distilled)	82	11%	9.2

*Theoretical values if cables were constructed of these materials.
ε = dielectric constant

Table 1. Electrical parameters of various materials

TECHNICAL ARTICLE #2

At 100% VOP, the physical wavelength at 1000 MHz (1.0 GHz) will be 11.80 inches. This can be proportioned according to the cable's actual velocity factor, as well as other frequencies. A practical formula is:

$$L = 11.80 \times \frac{VOP}{100} \times \frac{f}{1000}$$

Or, reduced,

$$L = VOP \times f \times 1.18 \times 10^{-4}$$

where: L = Physical length in inches
VOP expressed in percent
f = Frequency in MHz

It needs to be understood, however, that even with the relatively uniform VOP figures in a given cable type, physically measuring them by the inch for phase matching is no assurance of an accurate match. This is because actual VOP is not always exactly the published figure, nor can it be considered perfectly uniform, even within a single production run of cable. Variances are apt to be more pronounced in cables having high VOP's. Only test equipment which measures electrical length with precision can verify meeting stringent standards such as required for TCAS directional antennas.

PIC produces cables which meet and exceed the requirements established for TCAS and other RF systems. Precise testing is performed to assure that crucial timing and phase matching requirements are met.

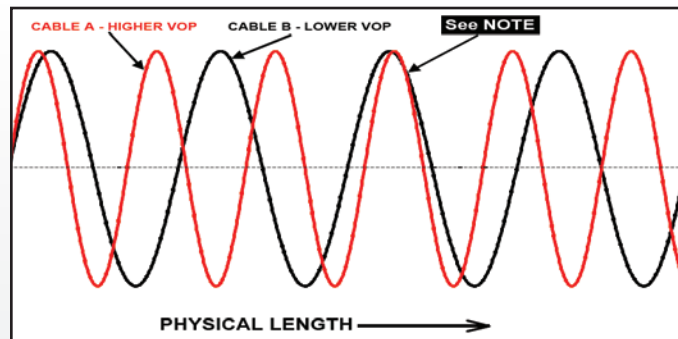

Figure 1. Relative physical length. NOTE: Cables A & B are identical length, and their phase angles are equal. However, because of different VOP's, they have unequal electrical length. This illustration shows them "slipping" a full cycle at some point - which could have been seen with accurate delay measurement.

Part No.	ϵ @ 1.0 GHz	VOP	Delay
PIC CABLES			
S22089	1.45	82.5%	1.2
S33141	1.56	80.5%	1.3
S44191	2.0	69.5%	1.5
S44193	2.0	69.5%	1.5
S46191	2.0	70%	1.5
S55122	1.4	84.5%	1.2
S67163	1.56	80%	1.3
S86208	1.6	80%	1.3
S88207	1.56	80%	1.3
V75268	1.4	80%	1.3
V76261	1.56	80%	1.3
SELECTED MIL-C -17 CABLES			
RG142, RG400	2.1	69%	1.47
RG214	2.3	66%	1.54
RG393	2.1	69%	1.47
RG58	2.3	66%	1.54

Table 2. Electrical parameters of center conductor insulation of coaxial cables.

A Related Issue: Dielectric Constant

This is a property of the material itself independent of dimensions but is an important factor in determining VOP and delay. The word electric derives from the Greek elektron, which translates to amber.

However, amber is an insulating material and is known to produce an electric charge when rubbed. And so even though we think of electric as inferring the flow of electrons (current), we now know that the term comes from some ancient insulator (which has even been known to entomb prehistoric insects. But that's another story already made into a hit movie or two.)

The prefix "di-" infers the effect of preventing this flow. A dielectric (amber would qualify) then, is a barrier-an insulator-separating positive and negative electric charges from one another, preventing direct current flow. This action is typified by a capacitor.

TECHNICAL ARTICLE #2

In a cable, the dielectric is defined as the nonconducting plastic or rubber (or even air) which insulates a conductor from others.

No conductor material is perfect and the same is true of insulation materials. There are superconductors, special alloys which, in a very low temperature environment, actually do exhibit zero resistance. A perfect vacuum is also an absolute, but is as yet unattainable. What about making cables using a perfect vacuum as the insulation medium? It's even more impractical than superconductors.

So, in the real world, while we might quantify absolutes without practical access to them, we can at least relate to them by a ratio. Thus defines the dielectric constant (electrical symbol ϵ) — the ratio of a material's dielectric (charge storage) quality to that of a perfect vacuum. A perfect vacuum is valued at 1.0. All other materials have a greater value of ϵ .

The dielectric constant figures into determining characteristic impedance, loss, capacitance, cutoff frequency and velocity of propagation of coaxial cables.

For example, the dielectric constant of solid PTFE (as used in RG142 and RG393) is nominally 2.1. This means that it will store about twice the charge as a vacuum, or, put another way, roughly doubles the capacitance. PIC's S33141 low loss coaxial cable employs a dielectric with an ϵ of about 1.8. It is lighter and thinner but electrically equivalent to RG393, and the dielectric constant is one reason why. Tables 1 & 2 list these details.

The lower the dielectric constant, the lower the loss, the lower the capacitance, the higher the velocity of propagation — a cable which approaches the ideal. But then we're talking superconductors with a vacuum for insulation, or at least we are venturing into currently impractical materials.

Some formulas for determining cable parameters related to the dielectric constant follow:

Impedance in ohms

$$Z = \frac{138}{\sqrt{\epsilon}} \log_{10}(D / d)$$

Velocity of Propagation (Expressed as a % of the Speed of Light)

$$VOP = \frac{100}{\sqrt{\epsilon}}$$

Capacitance in pF/ft

$$C = \frac{7.36 \epsilon}{\log_{10}(D / d)}$$

For the equations above,

D = Inside diameter of shield (inches)

d = Outside diameter of center conductor (inches)

ϵ = Dielectric constant

Calculating Voltage Standing Wave Ratio (VSWR) and loss, while the dielectric constant is a factor, is not as straightforward. For VSWR, it is also necessary to establish the reflection impedance and, for loss, the stranding and braid factors—all this being part of the cable design and engineering process.

The dielectric constant is not the only measure of quality of a cable; cellular polyethylene has an ϵ as low as 1.4, but it is rated at a lower temperature. MIL-spec coaxes using polyethylene dielectrics (such as RG58 and RG214) customarily also have PVC jackets and are, therefore, unacceptable for aircraft applications because of smoke and fire concerns.

But some newer techniques and chemistries have developed such things as foamed, wrapped or expanded tape high temperature dielectrics. All of these reduce the dielectric constant; but, as increasing amounts of air are incorporated, the material becomes softer and there is a compromise with strength. A nice solid extrusion of, say, PTFE is tough, but losses will be greater than with expanded PTFE tape. Then again, maybe it needs to be tough for practical or environmental reasons.

The trade-offs begin. Electrical performance vs. weight and strength—a never-ending concern in the avionics industry. Cost figures in, too, but often it is simply among the least of concerns.

TECHNICAL ARTICLE #3

Wire

We sometimes forget that many cables are not designed to conduct electrical power or signals, such as cables which support bridges, actuate ailerons, and tow cars, for example. Mechanical wire & cable is a big (but another) industry.

There are, however, similarities between mechanical and electrical wire and cable at least in terms of their means of manufacture.

As strands of wire are made, they are drawn through progressively smaller dies. This is true of all wire. Diamond dies are used, due to their extreme hardness, and the fact that they retain their precision size for a long time. In fact, the American Wire Gauge (AWG) sizing system suggests this drawing procedure. For example, a size 22 AWG wire, smaller than 20 AWG, is drawn, theoretically, through 22 progressively smaller dies. Larger wire is drawn through fewer dies; hence, the lower number "gauge." See Table 1.

Bare Annealed Copper

AWG	Dia (in.)	Circular Mils	Ohms per 1000 ft.	Lbs per 1000 ft.
10	0.1000	10000	1.00	31.43
12	0.0791	6250	1.60	19.77
14	0.0633	4000	2.50	12.43
16	0.0500	2500	4.00	7.818
18	0.0395	1563	6.40	4.917
20	0.0316	1000	10.0	3.092
22	0.0250	625	16.0	1.945
24	0.0200	400	25.0	1.223
26	0.0158	250	40.0	0.769
28	0.0125	156	64.0	0.484
30	0.0100	100	100	0.304
32	0.0079	63	160	0.191
34	0.0063	40	250	0.120
36	0.0050	25	400	0.076
38	0.0040	16	640	0.048
40	0.0032	10	1000	0.030

Table 1. Chart of wire sizes. Circular Mils is the square of the diameter in thousandths, and is useful for comparison of the cross-sectional area of a conductor.

Metals

Copper is regarded as the standard in electrical conductors, second only to silver in conductivity, but far more plentiful and therefore economical.

Because soldering copper can be difficult unless a flux is used (which can leave corrosive residues behind), it is usually tinned or plated if it is intended to be soldered. (This does not preclude the use of flux, but the coating makes soldering easier, and affords some protection against corrosion overall.)

Bare copper is perfectly suited for pressure terminations (crimping, etc.) which break through surface oxidation. Aluminum's lighter weight would suggest it being favored for the weight conscious aircraft industry. Its weight is about 1/3 that of copper, and even with its poorer conductivity, it performs better than copper on a per pound basis by a factor of almost 2:1.

So why isn't aluminum preferred? To start with, the physical attributes of wire are only part of the story. Years ago, when copper was in shorter supply, aluminum was often chosen for residential wiring. What was not fully appreciated at the time was the serious effects of the galvanic reaction between aluminum and the brass or copper fittings or terminals in the presence of moisture. This would develop corrosion which would cause failure at the connection, either in the form of an open circuit or, worse, a high resistance, which spawned many a fire. Aluminum proved to be galvanically too aggressive to be placed in direct contact with copper or brass. (Table 2 lists a selection of metals according to their galvanic ranking.)

The same problem exists in other circuitry. If all terminations were changed to aluminum, the galvanic problem might be solved, but this would apply to all the pins, terminals, contacts, and conducting hardware, and there are a lot of existing systems which would need adaptation. Then, too, aluminum develops a hard layer of oxides on its surface, and this must be penetrated for a good electrical connection.

Although a second best solution, there are bimetallic ("AL/CU") adaptors which interface aluminum and copper conductors where rewiring a home is impractical. These solve the galvanic action which compromises fire safety.

TECHNICAL ARTICLE #3

One other serious deficiency of aluminum is that it cannot be easily soldered or plated to improve solderability.

All this may suggest there is no legitimate use for aluminum in electrical systems, let alone on aircraft. Not so. In truth, aluminum is approved for airborne use in 6 AWG or larger gauges. This is aimed at power applications, not avionics systems. At the high currents appropriate to large conductors such as these, the effects of possible corrosion are compensated to some extent by the current itself.

Silver conducts better than copper, though it is substantially more expensive. As a result, it is often used as a coating for copper in order to improve skin conductivity and offer some protection against corrosion. This is of particular value at very high frequencies, where the current is more apt to concentrate at the "skin" of the conductor, a phenomenon called skin effect. Silver is also readily soldered.

Tin provides corrosion protection for a copper conductor, but does not appreciably affect its conductivity. It is, of course, eminently solderable. A conductor which is "tinned" may actually be coated with a lead tin alloy—a solder.

Gold, though pricey, is a common plating for brass connector pins, ARINC coax contacts, and parts of some other connectors. Fundamentally, this is the plating of choice because of its excellent corrosion resistance properties in applications where there can be great exposure. Gold is also a good conductor and easily soldered.

Table 3 lists a selection of common conducting materials and their properties, both absolute and relative to copper.

Galvanic Series	
LEAST NOBLE, CORRODED	
Mg	Magnesium
Zn	Zinc
Al	Aluminum
Cd	Cadmium
Fe	Iron
Cr	Chromium
-	Lead-Tin Alloys
Pb	Lead-Tin Alloys
Sn	Tin
Ni	Nickel
-	Brass
Cu	Copper
-	Bronze
-	Silver Solder
Ag	Silver
Au	Gold
Pt	Platinum
MOST NOBLE, PROTECTED	

Table 2. Common metallic elements in their order of galvanic potential. Those closer together on this list will be less likely to attack one another in the presence of an electrolyte than those more widely separated. For practical purposes, any moisture other than distilled water can be considered an electrolyte and will induce corrosion. The element nearer the top will be the one affected.

Jacket & Dielectric Materials Insulation Temperature Ratings

PVC is a poor choice for wire and cable insulation on aircraft—a position affirmed by the FAA. Other good, and approved, choices exist and are readily available. Temperature ratings reflect the range within which the integrity of the insulation will be maintained—sufficiently flexible when cold and free of the effects of softening or disintegrating at the high end of the scale. It should be noted that the upper temperature rating should take into account the heat rise caused by power dissipation in the conductor itself.

	For 30 AWG Wire					Temperature Coefficient ²		
	Relative Resistance	Ohms per 1000 ft.	Lbs per 1000 ft.	"Ohm-Lbs" ¹ per 1000 ft.	Melting Point (°C)	Specific Gravity	ΔR per °C	ΔLength % per °C
Copper	1	103	0.304	31.4	1083	8.89	0.0039	16.1
Aluminum	1.64	169	0.092	15.6	660	2.7	0.0039	28.7
Silver	0.94	97	0.359	34.9	961	10.5	0.0038	18.8
Gold	1.42	146	0.661	96.6	1063	19.32	0.0034	14.3
Tin	6.7	691	0.25	172.7	232	7.3	0.0042	26.9
RELATIVE TO COPPER								
Copper	100%	100%	100%	100%	100%	100%	100%	100%
Aluminum	164%	164%	30%	50%	61%	30%	99%	178%
Silver	94%	94%	118%	111%	89%	118%	97%	117%
Gold	142%	142%	217%	308%	98%	217%	87%	89%
Tin	670%	670%	82%	550%	21%	82%	107%	167%

Table 3. A comparison of common conducting materials. ¹Ohm-Lbs per 1m ft" is a calculated figure which illustrates the relative weight advantage of each material. This is only for comparison purposes and has no real design purpose. ²Temperature Coefficient is the factor which applies to changes in resistance, or physical dimension for each degree Centigrade. Note the considerable difference in coefficient of expansion between copper and aluminum – yet another reason for their incompatibility. It can be noted that aluminum's main advantage is weight.

TECHNICAL ARTICLE #3

While most airborne wiring is not expected to endure exposure to the rated temperature extremes, such ratings provide a measure of "head-room" to assure safety in the event of fire or malfunction.

Other insulation properties of concern, depending upon the applications, include the dielectric constant, which dictates loss, mutual capacitance (between conductors), impedance, velocity of propagation, etc. [Refer to Technical Paper 2—The Velocity Factor]

The most prevalent wire & cable insulation materials approved and generally acceptable for aircraft are from the Teflon® family—a familiar brand name for fluoropolymers which include, for example, PTFE, ETFE (also known as Tefzel®), TFE, and FEP.

MIL-W-22759 wires are TFE or Tefzel® insulated. TFE insulation is rated for upper ambient temperatures ranging from +200°C to +260°C, depending on thickness of the insulation and conductor materials. Tefzel® is typically rated at +150°C. Both are suitable to 65°C—which may be realized in proximity to the skin at high altitudes.

Temperature/Performance Issues

There are some old "standby" coaxial cables—RG58 and RG214, for example—and some newer low-loss cables which can actually cause serious performance problems in avionic systems. Their usefulness is flawed by the use of polyethylene as the dielectric material. This results in a temperature rating of, typically, 85°C (which equals 185°F), which, on first glance, may seem entirely adequate.

But airborne systems are much more safely served by cables with a 200°C rating. Now, 200°C is a whopping 394°F—hot enough to melt solder! Certainly way above human tolerance. So, is it overkill to specify (and pay for) 200° rated cables? Decidedly not. And here's why. Many avionics technicians are aware—from experience, if not by science—that the use of "high temperature" cables is preferable to the less expensive coaxes. The reason is performance—maybe not at the outset but over time.

In a great many aircraft, cables snake through the airframe in places that can become much hotter than the cabin. Even though contact with or proximity to air ducts, engine firewalls, and other hot spots won't see temperatures even approaching 200°C, it's not uncommon for them to experience touch-points well above 100°C. It's there that the damage can happen. What damage?

A little background: Coaxial cables are, by definition, coaxial—that is to say, the cylinder of shielding and the cross section of the center conductor share the same axis. The space [dielectric] between them is the same all the way around. Ideally.

Lower temperature dielectric materials soften at relatively low temperatures and inevitably the center conductor migrates off-center, toward the shield, in the direction of gravity or the inside of a bend in the cable. In such a case, the "co-axis" goes off axis, and the concentricity essential to maintaining impedance is impaired. This is permanent and just part of the damage that can happen.

The other part occurs at the box. In the case of a receiver, changes in impedance can cause a reduction in signal—possibly to the point of loss of usefulness.

In the case of a transmitter, things can get worse. The reflection of power [measured as SWR, or Standing Wave Ratio] comes right back to the final stage, producing heat...and heat is the archenemy of all electronic components. This is an invitation to the bench for repairs. Do you know someone who would rather pay for repairs than the modest extra cost of 200°C cable?

Cables using 85°C-rated polyethylene (PE) dielectric materials become soft at temperatures common in isolated spots in aircraft. Some low-loss cables use foamed polyethylene which is soft to begin with. Cable routing with careful attention to avoiding hot spots is important in general, but crucial with such cables.

With so much riding on the integrity of cabling, doesn't it make sense to always use the better choice?

There have been reports of TCAS II installations showing signs of RF cable deterioration after only a few years of operation. The cause of these problems has been traced to moisture either in the coaxial cable at the antenna connector or inside the connector itself.

Moisture trapped inside a connector can produce effects ranging from unnoticed to serious, depending on the demands of the system. But be assured the cable assembly will be affected if moisture enters. The shields and conductor can suffer corrosion, especially if cleaning is less than meticulous when the connector is applied. However, even if corrosion were not to develop, moisture present in the connector or dielectric can change the characteristic impedance of the cable. Where there is a change in impedance, there is an increase in signal reflection (VSWR). As a result, a sensitive system may become unreliable or, worse, fail.

Before making a blanket indictment of the connectors, cables, cable assembly techniques and/or installation practices, let's examine the factors that can create this problem.

Moisture can become trapped inside the antenna connector as a result of repeated exposure to significant swings in temperature and atmospheric pressure in the presence of significant relative humidity.

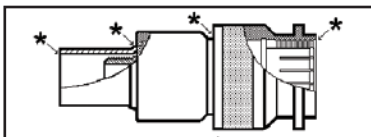

Figure 1. Points of entry for moisture shown for a conventional unsealed TNC connector

(See Figure 1) In commercial air transport jet aircraft (which account for most TCAS II installations), air temperatures at the skin can cycle from as much as, say, +120°F on a Phoenix ramp to 60°F at 35,000 feet. Pressure may change from about 30 inches of mercury at sea level to about 7 inches (a 75% drop) at 35,000 feet; cabin pressurization, however, can reduce the effect to about a 15% drop.

Such temperature changes can precipitate moisture in the air, and a drop in cabin pressure can create a partial vacuum in and around the connector. During descent, though the warming of the skin tends to return the moisture to the air, some of it can be drawn into the connector as the pressure returns to higher levels. All this happens differentially; conditions inside the connector will not change as quickly as those around it. Over time, it will equalize again, but there is no way of knowing what "over time" might be.

At the risk of downplaying the advantages of the newer, softer, more porous dielectric materials, it appears these, too, may be implicated in this. Their lower loss, smaller diameter, and lighter weight are important elements in selecting cables for airborne applications, but there is a price to pay. It has to do with the porosity of the dielectric. In effect, the layers of thin Teflon® tape wound around the center conductor resemble a roll of corrugated cardboard. You can picture the spaces for "stuff" to get into. [An exaggerated analogy, of course.]

Solid-dielectric cables go back long before TCAS and might be considered the solution, but it must be noted that they are hardly immune to the effects of moisture, and the interior of the connector is still a trap for moisture. A solid dielectric is less absorbent, but the corrosion risks to the conductor and shields are the same. And there are other drawbacks: solid-dielectric cables can add pounds to an installation, and will occupy more space because of the larger diameter necessary to meet loss requirements. They are stiffer and will have greater bend radius requirements and so may require other routing considerations in installation. These problems often dictate the choice of the higher performance construction.

Now, at least theoretically, whatever moisture goes in can also get out. Given the conditions (and freedom) to dry, the problem could be only temporary. Right?

Actually, trapped in the tiny space of a connector, a return to dry-as-the-day-it-was-made is simply impractical—even more unlikely considering the fact that the water in the dielectric isn't just sitting there waiting to evaporate or be poured out. It may have wicked its way back into the cable by capillary action. Removal by dry heat in a vacuum may be possible, but even if it worked it (1) is tedious, (2) requires special equipment, and (3) calls for undoing and rebuilding the connection at the affected end. All this on top of the R&R of the installed cables in the first place!

So it becomes evident that problem prevention is vital: stop the free flow of moisture into the connector.

ARINC Characteristic 735 doesn't specifically call for weather-sealed antenna connectors. In fact, when it was adopted, the risks of moisture in advanced, lightweight coax were probably not much of a consideration. (These issues are not mentioned in the Characteristic.)

Weather-sealed connectors are available, but no one knows their long-term ability to block the passage of damaging moisture. However, we do know that weather sealing helps. The objective here is to prevent moisture from oozing into the space inside the connector where it can get to the exposed end of the cable.

Nothing plastic will seal completely against water molecules in the air, but weather seals will stop the condensed water. A layer of dual-wall (hot-melt glue on the inside) heat-shrink tubing over the cable and fixed end of the weather-sealed connector adds strain relief, but is not adequate moisture protection by itself.

A hermetic seal is the ideal since it blocks the passage of the smallest molecule. It is common in situations such as ceramic package IC's, light bulbs, etc. where there must be no chance of the outside atmosphere getting at the sensitive interior. However, a true hermetic seal is accomplished only with the flow of metal to glass or ceramic—obviously a high temperature operation, but not practical in cables, or most other things for that matter.

PIC's Role

From the beginning, PIC has provided weather-sealed antenna connectors on the coax assemblies we make for TCAS II, TCAS I, Mode S, GPS, SATCOM, MLS, and other RF applications. Also the added protection of dual-wall shrink tube is standard on all PIC cable assemblies. These two measures of sealing provide maximum practical protection against water absorption in coaxial antenna connectors.

The concerns of the commercial aviation industry — especially all TCAS II users — over the effects of moisture in antenna cables are real. Some suggest that correction and prevention of future system problems will get constant attention until there are more answers.

Fact is, connections of all kinds in aircraft are susceptible to environmental contamination. Problem connections include those with the following parameters:

- RF above 100 MHz
- System-defined loss budgets
- Connections at the antenna
- Non-pressurized cabin location

Of these, it is self-evident that there is greater proximity to wide temperature excursions at the antenna. Coupled with moisture in the atmosphere (as opposed to flowing water, which would suggest a leak at or around the antenna) there will be absorption—and not necessarily just a little.

One major airframe manufacturer reports that moisture can wick deeply into expanded tape dielectrics (typical of low-loss coaxial cables) as much as four feet from the connector. (See the sidebar "In Defense of Low-loss Cable" at the end of this article.)

While loss effects may be unnoticeable at such a distance, it stands to reason that the longer the span of wet dielectric cable, the greater the attenuation. This contamination by what could be classified as distilled water (in the air, remember) changes the dielectric constant materially, affecting impedance of the cable. As a result, the VSWR is increased and loss suffers.

Any cable in systems where a minimum loss is specified is at risk, especially those produced with a smaller amount of "leeway" than others, and some system parameters put a limit on that. See Table 1.

	LOSS LIMITS	
	MINIMUM	MAXIMUM
TCAS II (per ARINC 735)	2.0 dB	3.0 dB
TCAS I (Allied Signal)	2.0 dB	3.0 dB
TCAS I (BFG)	None	1.5 to 6.0 dB*
Mode S (per ARINC 718)	1.0 dB	3.0 dB

**Requirements Vary*

Table 1. List of some of the high/low limits of antenna cable insertion loss for avionic systems. Measurements are specified at 1030 MHz except for BFG TCAS I which is specified at 1090 MHz.

Serious Implications

There have been TCAS and Mode S failures attributable to moisture in the antenna cables. To the extent this is the case the potential consequences are far-reaching.

For one thing, the major role for Mode S transponders is not to make reports to TCAS-equipped neighboring aircraft but to transpond to ATC radar for safe management of the airways. This applies to Mode A and Mode C transponders as well.

Another complication arises in that, while some Mode S transponders are set up to notify the crew of failure, some are not. Dual transponders may be unable to overcome such failure since it occurs in the one common element of the system: the antenna cable.

So something as simple as an unprotected coaxial connection can cause a transponder to go silent without notice. Notwithstanding our confidence in our air traffic control system, it adds to the burden to deal with aircraft which fail to supply helpful, if not vital, data.

Repairs

Type C connectors, used on Mode S antennas, are more susceptible to the passage of moisture than TNCs which are used on TCAS antennas. The pressure on the mate gasket is likely at fault; the Type C has a bayonet-like fitting, while TNCs are screwed onto their mating connectors with the potential (and probability) of a tighter fit against the gasket. See Figure 2. Both, however, have been implicated in moisture problems.

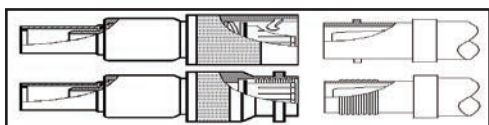

Figure 2. – Type C (top) and TNC mating schemes. Note that the TNC is capable of greater pressure against the sealing gasket due to its threaded mating scheme, as opposed to the Type C which has a spring-loaded bayonet type connection.

Next, if the pathway for moisture at the cable entry point is unsealed, it may as well be wide open. Some might argue that if it is so open, it will expel moisture-laden air just as readily as it takes it in, leaving the connection in environmental equilibrium. However, there is never complete reversal of such events; an absorbent cable dielectric is always going to be "a little thirsty" when moisture is present. This typifies the principle of capillary action.

If a section of wet cable can be completely dried, which is next to impossible, or removed (How much do you cut off?) it can be re-terminated and deserves to be sealed as thoroughly as possible.

Some Assumptions

The following may make this a little less formidable, but bear in mind they are assumptions.

It might be assumed that the worst of the absorption is in the first few inches of the cable. This length is going to be longer in low-loss cables than in solid-dielectric RG-type cables. Secondly, it might be assumed that cutting and reterminating the cable with a new, properly sealed connector (not just wrapped in dual-wall shrink-tubing) will solve the problem.

However, assurance of restored cable performance comes only with appropriate testing for loss, VSWR, delay, and phase angle (if required).

If the removed length is to more certainly eliminate "all" of the entrapped moisture, it may shorten the cable too much. Add another piece? Not a good idea. Now you start compromising.

Here is one final reason to bite the bullet and replace the cables altogether: with a repaired cable there is still the uncertainty of trapped moisture which can in time enhance the corrosion process and produce yet another mode of failure. Does it buy time? Yes. Does it overcome the problem? Only maybe.

Prevention Now

Existing installations may or may not be a ticking time bomb, but so far there is no pattern to suggest that any particular locations or aircraft are less at risk than others. Nonetheless, taking immediate steps to add protection to mated connectors may at least delay the onset of moisture caused cable/system failure.

Simply disconnecting the connector from its mate, air drying both, and reconnecting it with a dual-wall heat shrink sleeve over the entire connection, including several inches of the cable, is truly inadequate. Moisture remaining inside the cable and connector are not only ignored; they become trapped.

Actual removal of the connector from the cable and retermination after drying may produce acceptable results temporarily, but it is a poor second to making a complete cable replacement. Needless to say, replacement connectors should be of weatherproof design. (Figure 3 illustrates typical weatherproofing.)

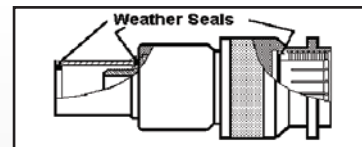

Figure 3. Typical connector weatherproofing. Shows recommended extra protection of dual-wall shrink tube over cable and connector. This covering might also be a wrapped sealant mentioned in the text below, and could cover the entire connection as well.

Final Analysis

While there is certainly more experience to be gained, what has been learned so far is:

- Moisture absorption problems are worse in cables with wrapped dielectrics than those with solid dielectrics.
- Moisture absorption is exacerbated by the wide pressure and temperature excursions common to aircraft.
- One effect of moisture is to reduce the dielectric constant, changing impedance, worsening VSWR, and increasing loss.
- Maximum seal potential is realized when using connectors with built-in seals and dual-wall heat shrink tubing or other appropriate sealing method.

For certain, new installations ought to include connectors designed to be inherently weatherproof at both the cable end and the mating end—with gasketing designed in. The additional surrounding protection should be incorporated at the time of cable assembly, and wrapping the entire mated connection at the time of installation adds yet one more layer of protection.

In Defense of Low-loss Cable

In recent years, advances in manufacturing process for coaxial cable dielectrics have brought us more air – specifically, microscopic spaces incorporated into the Teflon tape which is wound in an overlapping spiral around the center conductor.

The wound-tape configuration and open air “cells” lead to capillary action, like a sponge in some respects.

While this is, in effect, more apt to draw and trap water molecules, it does result in improvements in cable performance: notably, lower loss, higher velocity of propagation, and lighter weight – to name a few.

These advances far outweigh the risk of moisture contamination, if steps are taken to create a suitable barrier to moisture exposure – or better, if used in a controlled environment.

In aircraft, the environment is almost hostile. Yet the measures covered in this paper can and do reduce the ill effects of moisture on critical parameters.

Have we been "given the ax" by the cable designers & namers of old? Well, no. The "-ax" is short for "-axial", of course, and refers to the lengthwise axis of the cable. And when it's abbreviated as "-ax," the word "cable" is also implied.

Here's a rundown of the common "axial" cables.

Coax (coaxial cable) consists of two conductors which share the same axis. To do this, and to separate them electrically, at least one must be cylindrical and larger in diameter than the other. Coaxial cables are inherently unbalanced, which may be bad news concerning immunity to EMI, but this is often overcome by their efficiency in connecting to high frequency antennas. The choice of coax is ordinarily dictated by the antenna design itself.

In referring, above, to "at least one must be cylindrical," this acknowledges use of a hollow center conductor used in some large cables to take advantage of the skin effect (at high frequencies) in which nearly all the signal is confined to the outside of the conductor. The core material can be eliminated with little effect on performance, and can result in reduced weight or cost.

Interestingly, there are specially designed coaxial cables which, themselves, function as antennas. They are constructed with a slit or perforated shield, which ordinarily would be a poor design, but leak enough signal to/from the center conductor that they radiate over their entire length. These are used, for example, in subway tunnels to provide RF access to those systems operating underground.

There are many designs of coax, including those with sophisticated, highly-effective multiple shields, and many different cable diameters with corresponding higher losses in smaller [center conductor] gauges and low loss in the larger gauges. And there are many differences in insulation materials which affect safety, flexibility, and signal handling. The technology is constantly changing.

Multiple shields in coax are normally "unitized," that is, electrically connected to one another.

Triax resembles coax in that all the conductors share the same axis, but there are three of them. At least two of these must be cylindrical and insulated from one another and the third conductor. So it is actually a three-conductor "co"-axial cable.

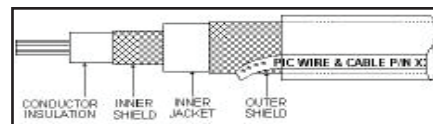

Figure 1. Triaxial cable design.

Triax can be used in many coax applications, but offers an additional, separate shield—not just another layer of shielding. The outer shield covers the "coax" inside and can add an extra measure of EMI protection.

Quadrax is a four-conductor cable. The two separate shields share the same axis, but the two remaining conductors are a twisted pair. Like triax, the shields are insulated from one another, which helps improve noise immunity. It is also well suited to confining noisy signals, such as pulses, from interfering with other low-level circuits. This explains its application in radar display buses.

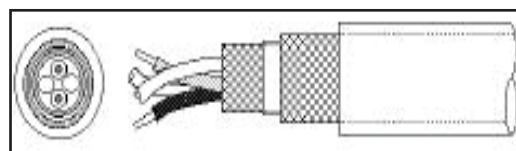

Figure 2. Quadaxial cable design.

Its greatest usefulness is below 50 MHz.

Twinax also has two twisted conductors, but they are surrounded by a single (or double, but not isolated) shield. Twinax almost completely violates the common-axis idea — unless you consider the "pseudo" -axis of the twisted pair. (Historically, the name was devised to imply a "next generation" of coax, primarily in data communications applications, though twinax is no longer a preferred medium for new applications in this market.)

There are many variations within all the "-axial" designs, but a basic understanding of their family names may help in making sensible application decisions, or at least better appreciating the decisions made by avionics and airframe engineers.

Shortcuts (no pun intended) can lead to wire failure. These can result from, among other things, the press of time or contortions from working in confined workspaces.

For example, when removing insulation from any wire for connection or termination, nicking the conductor is all too possible, and it has serious consequences.

There are enough problems with connections (that's where nearly all open circuits occur). Why cause a problem because the connection to the connection is poorly made?

Stripping The Insulation

In its worst case, a wire-stripper may actually remove a strand or two along with the insulation, leaving a shortage of conductors at the termination.

What happens is that, for example, only five of seven strands have to carry all the current. This creates a bottle neck, overburdening the surviving conductors and making them prone to failure with possibly intermittent strands all of which can produce extra heat, circuit noise, and/or changes in resistance.

With vibration or even a small amount of stress, a "mere" nick can develop into a crack which may break and fail, almost always long after the connection has been made. While stranded wires will "bottleneck," as described above, a solid conductor may open completely! NOTE: There is no such thing as a "mere" nick.

You cannot "fix" a nicked or broken conductor; cut it off and start fresh. And when you do, be sure to use tools which will sever only the insulation, staying clear of the conductor below.

How do you assure this? After all, insulation materials are generally a lot softer than copper, and sometimes you just can't tell by feel that you have "touched bottom."

Stripping Tools

Here's a review of some of the tools found in common use:

1. **Thermal strippers** are the kindest to the wire and will soften most insulation materials. Available in hand-operated or bench types.
2. **Motorized hand and bench strippers** have a spinning collet, which receives the wire. Adjustable blades can be set to a uniform insulation depth and will slice and then remove the "slug" of insulation without damage to the conductor. Some of these are very precision tools. And some are very expensive, but worth it, for production situations.
3. **Pliers-like mechanical strippers**, with one or a range of slots for different AWG diameters, are inexpensive, handy, and perform well—provided the correct slot is chosen, the wire is well centered in the slot, and the cycle is smoothly performed. Counterbored die-type blades help greatly in centering the wire.
4. **Inexpensive stripping pliers** may also have one or more sharpened notches, often V-shaped—a poorer choice, requiring considerable care—and some means of limiting their closure. Experience is vital—and yours may already have steered you away from this tool.
5. **Diagonal cutters** are always handy but a poor choice, relying on just the opposing edges (usually dull and better at holding than cutting insulation) and considerable skill. Diagonals grab and stretch the insulation to the breaking point in order to remove it—kind of an "all thumbs" approach. This process also leaves the length of the strip rather unpredictable due to the stretching. This tool is truly designed for simply cutting wire, but even so, it is inferior (for that purpose) to cable cutters which scissor-cut a nice squared-off end instead of mashing the wire.
6. **Razor blades.** Nice cut, but control can be a problem. Actually, with skill and care a razor blade can prepare the insulation for removal with diagonal cutters, or even by hand. A razor blade is best used to "circumcise" or score the insulation partway to define its breaking point. This can result in a rather precision length of strip and, in fact, may be necessary in the absence of more sophisticated tooling. It's not uncommon to use a razor blade to help in the stripping of coaxial cables.
7. **Pocket knives** are fine for whittling.

So, given a variety of tools, we recommend not leaving this delicate task to the inexperienced.

Further, as with any "tools of the trade," quality is never a poor investment, and maintenance is a necessity. A dull anything is actually a comment on the technician's concern for quality performance.

Professionalism and aircraft system reliability demand meticulous attention to detail. Choosing and using the best available tool for the job, double-checking everything, and performing careful inspection before completing the termination will help assure the long term quality of installation.

Gas-Tight Connections

The enemies of electrical continuity are purely physical. Chemical corrosion is the most insidious, because it doesn't appear until some time after the connections are made, tests are performed, and the installation is pronounced successful.

This is a serious problem, but there are solutions.

In corrosive atmospheres, considerable effort is required just to protect the connection against exposure. This involves seals or enclosures or "goops," but underneath it all there must be a gas-tight bond between the wire and its termination. Only a true hermetic seal can provide absolute protection of an exposed connection.

Making Sound Connections

It is not difficult to make a gas-tight connection. Even amateurs do it inadvertently yet even professionals can fail unless certain precautions are taken.

There are many ways to terminate a wire: soldering; crimping; under the head of a terminal strip screw; welding...all can be successful in forming a good, gas-tight connection. While each has its place, they all require low resistance consistent with circuit demands. This means the conductors must be clean at the point of contact—clean enough to put pure metal in intimate, permanent contact with pure metal.

To begin with, every conductor deserves a measure of basic cleanliness. Oils, wax, water, rust, corrosion, scale, dirt—in short, everything that can be reasonably removed should be—by wiping with a solvent or, in some cases, scrubbing or abrading the surface. After drying, the connection should be made as soon as possible, before surface corrosion can take hold.

Some conductors are chemically more active than others, that is, they will form poorly-conducting surface oxides which act as a barrier, not always obvious because they may be, in effect, transparent. In some cases, however, these oxides are readily broken in the process of connections made by pressure, or they will flow into a hot medium such as solder, or evaporate when welding.

About "Gas-Tight"

Gas-tight means sealed against the possible penetration of air molecules, as well as any "tag-along" airborne contaminants. Metal-to-metal gas-tight connections are those where oxides or other surface contaminants are absent or removed, if necessary, by mechanical or chemical means.

Hermetic sealing is molecular, impenetrable, and gas-tight, usually employing insulators, such as glass or ceramic, which are heated in order to flow around and seal a metallic conductor. Examples include ceramic-package semiconductors, light bulbs, mercury-wetted or dry-reed relays, and the feed-thru connectors incorporated in PIC Quad group connector arrays. There are no plastics which can effect a true hermetic seal.

This is not to say that excellent protection is impossible without glass-to-metal sealing. It is the constant goal of designers to defy the pressures of the environment. Many excellent sealants and techniques are available to "prevent" (i.e. delay) leakage of corrosive gases; however, in the strict sense, they are not hermetic.

Before the impression is given that there is no practical means of defeating corrosion, it should be understood that the connection itself is readily made to be gas-tight. That is, creating an inter-metallic bond is the first step. The second step is surrounding the exposed metal with enough protection to keep the environment from causing enough corrosion to damage the current path.

Fluxes

It is common to use oxide-destroying chemicals—fluxes—before soldering or welding. Because welding is rare in avionic installation, we will focus on soldering as the most popular heat-involved connection process. But keep in mind that safety restrictions on fueled aircraft forbid soldering without special precautions.

Acid fluxes. Among the great fluxes for metal cleaning before soldering is the dreaded acid flux (several types), which not only dissolves oxides but etches the metal. However, acid fluxes are suited only for mechanical (such as jewelry, sealed containers, copper plumbing, etc.) joinery, never electrical soldering. Eliminating every trace of flux residue is impractical, if not impossible, and even a few stray acid flux molecules can cause corrosion.

Rosin fluxes become chemically active with heat and dissolve the oxides on tin, silver, and clean copper reasonably well. They are nonconductive at room temperature, but it is important to clean residual flux from the connection because moisture can combine with it to form a corrosive substance which could affect the connection over time.

There are many types of rosin fluxes available, and the solder manufacturers are helpful in directing you to the best choice for your particular applications. Suffice to say, however, that high quality flux-cored solders incorporate a flux which will perform well in the great majority of field or bench-soldering operations.

Cleanup is another problem—especially where a solvent can wick into the crevices of the wire, even up under the insulation, carrying flux residue with it. Electronic chemical manufacturers are helpful in selecting appropriate solutions and can offer advice on maximizing their effectiveness.

Flux-less Soldering

It should be added that no flux may be needed if the metals to be soldered are clean, perhaps freshly stripped, and tinned to begin with. Obviously, this eliminates flux removal concerns but such a process calls for careful evaluation and preparation, not to mention inspection after soldering. A classic no-flux soldering process is re-flow soldering, where sufficient clean solder is already applied to the surfaces to be joined, which are then placed together. Heating causes the solder to flow and complete the joint. This process is mandated in some military and aerospace applications, and is common in circuit card manufacturing.

Crimping

Crimping comprises the majority of wire terminations in aircraft where quick, easy, and reliable contact is called for. Crimping may be the method of choice if other methods compromise safety in fueled aircraft.

It is generally understood, however, that a soldered connection is superior where signal frequencies above 1,000 MHz are involved. This may be reason enough to consider special accommodations, even to the point of removing cables to make the connection or making terminations before installing cables. One good reason for using pre-made RF cable assemblies.

The barrel of a crimp-type terminal fits snugly over the wire and is then deformed, or crushed, using a tool chosen or adjusted to "dent" or deform the barrel to the proper depth and length. Depth of this dent is important to assure that the wire surface(s) and the inside surface of the barrel are in maximum, intimate (gas-tight) contact. The length and location of the crimp must be carefully placed so that only the area surrounding the wire is deformed, not other parts of a pin or terminal. Both depth and length contribute to mechanical strength.

One of the benefits of the crimping process is the breaking up of surface oxides by the sheer force of deformation.

About Fluxes

MIL-F-14256 is the standard for definition of fluxes used in electronic soldering. Considerations as to corrosive and/or conductive residues are most pertinent, and a variety of chemical compositions address the relative solderability of various metals.

Most prevalent among flux-core solders is activated rosin (Type RA) – a formulation which MIL-F-14256 states may cause corrosion under some circumstances. MIL-F-14256 recommends complete removal of RA flux residue, and states a preference for less activated formulas Types R (rosin) or RMA (mildly activated rosin)

Solder manufacturers, however, claim core formulations, meeting military solder specification QQ-S-571 Type RA, are non-corrosive and non-conducting. There is long history of satisfactory performance which lends itself to confidence in the type of flux.

Is there a message here that all is well with the activated rosin fluxes?

The recommendation is to use solder and flux according to system manufacturers' recommendations, or appropriate military designs if called for.

Cleaning residues is always a good idea – even for Type R fluxes whose residue, while considered no problem as to corrosiveness or conductivity, can affect subsequent bonding with conformal coatings, if used.

And then, while some fluxes are water-soluble, Types R, RMA and RA require alcohols or chlorinated solvents – the ozone-depleting chemicals which are said to affect the atmosphere. But that's a whole 'nother topic.

To make a gas-tight crimped connection, it is important to begin with clean wire and properly-sized terminal or pin. Obviously, a terminal with too large an internal diameter will not form correctly around the wire, leaving excessive space to harbor contaminants, and could even fall off (insufficient deforming) or crack (excessive deforming). Too small a terminal invites strand-cutting or some other form of butchery.

Every terminal is designed for a specific-size wire (or range of sizes) and has a recommended tool, die or tool setting for correct application. See Table 1. Truly consistent crimps are performed using only cycling-type tools—those that will not release the terminal until the crimping operation is complete.

TERMINAL SIZE	COLOR BAND	WIRE AWG	CRIMP TOOL	POSITIONER
22	Green	22-26	M22520/2-01	M22520/2-23
20	Red	20-24	M22520/2-01	M22520/2-03
16	Blue	16-20	M22520/1-01	M22520/1-02
12	Yellow	12-14	M22520/1-01	M22520/1-11

Table 1. Common ARINC pin/crimp specifications. Terminals are per MIL-C39029 and are all gold plated.

Even the lowly screw terminal (on a household light switch, for example) is capable of an excellent gas-tight connection. Assuming things are clean, the pressure and scuffing of the screw-head on bare wire penetrate surface oxides of both and make a good, low-resistance connection. This, of course, also applies to barrier-strip connections found in many electronic and power systems.

Low-loss RF Terminations

Making a good coaxial cable termination may be "second nature" to those who do it every day, but some avionic technicians don't have this luxury. So here are some tips you may find useful.

Almost all PIC coaxial connectors have the same "cut spec." Basically, this means that regardless of the cable size or the connector type, there is uniformity as to where cuts are to be made. Keeps things simple.

Not so simple is dealing with tape-wrap low-loss dielectric (the insulation between the conductor and the shields). This stuff is soft, delicate, sometimes "stringy" and hard to remove. But this is the magic ingredient that yields superior electrical performance.

Tape-wrap Teflon® has a way of conforming to the conductor—even to the point of getting buried in the tiny spaces ("interstices") between adjacent strands of a stranded conductor. It may be hard to completely sever when you make the cut, and surely you don't want to bear down on the blade just to get it all, only to create nicks in the conductor.

So you'll pull off the slug—most of it—and then very carefully pick at the stringy leftovers. This may not be fun & games, but an important part of making the conductor ready for the pin.

The advantages of PIC's weatherproofing on every connector will be realized only if potential leaks are eliminated. This is accomplished by trimming shield braid with care, one connector at a time.

If all this seems laborious, it is not. And we have thorough instructions provided with every connector. We also have a video—a "how to" run-through that shows every detail. Contact us to order a copy of this video.

So the process, while vital to signal or power continuity, is not at all formidable as long as the proper methods and tools are used. Skill and experience head the list and can assure long-term excellent connections.

Low-level circuits are often interconnected using shielded cables, mainly for protection against externally induced noise. Aside from the effectiveness of the shield designs themselves, even more important is the integrity of the connection to ground. A poor ground may be worse than none at all.

The Signal Return Path

Used as a signal return path, typical in coaxial cables, the shield serves a secondary purpose of screening the center conductor from external fields. This dual role can exist in non-coaxial cables as well.

The resistance of a braided shield is typically much lower than that of other conductors. This may be desirable in the return circuit, but it is especially important in presenting a low impedance against external induction. For this reason, terminations must be carefully made or the shield will be useless as a noise barrier. In fact, since the shield is a straight "wire" and its area much larger than the conductor(s) inside, a massive imbalance of induced current can occur, causing noise. An unshielded twisted pair would likely be more immune to noise.

Simple Shielding

As a pure barrier to EMI, a grounded shield acts as a conductive channel for the conductor(s) within. "Anchored" at ground potential, which prevents it from floating wherever the magnetic or electrical environment may lead it, the shield serves not so much as a means of walling off noise as to simply divide an offending electric field and send part of it into the ground.

It is important to know that no shield can protect against magnetic fields as effectively as mere physical space between the noise source and the affected conductors. As little as 0.5 inches can reduce magnetic coupling by more than 30 dB, improving to about 70 dB with a 4-inch separation. This is probably the best remedy for noise originating in high-current wiring.

Ground Loops

Ground loops cause a lot more noise than warranted, considering how easy it is to eliminate them with thoughtful installation. Ground loop noise is easy to picture: every conductor, including the airframe itself, has some resistance, and any current passing through it produces a voltage drop between its source and its load. See Figure 1.

The ground loop problem develops where more than one circuit share the same return conductor, often a shield intended to be the ground, so the voltage drop from one current path simply shows up in another, adding "someone else's noise" to an otherwise clean signal.

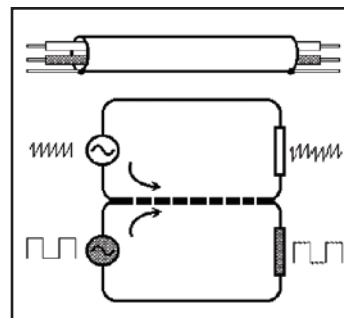

Figure 1. Ground Loops. The influence of one signal on another as a result of using a common conductor (shown as dashed line). Similar signal corruption can result from any current induced in any circuit – even stray fields, which can be especially troublesome and audible in 400 Hz aircraft power systems.

Further, where several systems are "daisy-chained" to ground, any one of them can act as a weak link and reflect its current fluctuations as noise through them all. Common grounds are best run in a star configuration.

Frame Ground

The return path should never be a frame ground. While it may be metal and able to conduct, is not intended to be an active conductor. The ideal return for any circuit should be exclusive to that circuit, though it is not uncommon to share return paths where the current of every signal is very low. Nevertheless, good practice suggests no more than five signal conductors per ground. Using a frame for a signal return or current-carrying "lo" is poor economy and an open invitation to problems. Best to reserve the frame for its structural role; however, connecting it to battery ground at one point will achieve the effect of a universal electrostatic shield for the entire aircraft.

An improved all-around approach to using a ground is to use it only as a ground, confining signals and power lines to dedicated conductors. A balanced, shielded twisted-pair audio line would be an example.

TECHNICAL ARTICLE # 7

Will the Real Ground Please Identify Itself?

Is there more than one "real" ground? Yes.

1. For a signal path the "real" ground is the system ground, the true destination for the return signal. No other reference point is as good. Good practice for connecting a protection-only shield calls for terminating it at system ground. This keeps it from floating with "alien" signal sources and becoming a source of noise to the very circuit it is intended to protect. It might be likened to an extension of the system housing itself.
2. What ground do you use between systems? Fact is, they may necessarily share the ground, as in the case of a signal between them via coaxial cable. If this is so, meticulous ground termination procedures are required at each end. Otherwise, a poor connection may cause serious noise almost anywhere, and continuity of the return path may be important. Ideally, signal returns should be isolated from ground and any shields terminated at one end only. See Figure 2. In some cases, the insulated outer shield of triax and quadax offer the shielding and the isolation desired. This permits the establishment of inner shielding as signal ground and return path, if necessary.
3. The "universal" ground, the airframe, is the shell housing all other systems. But it is only the shell and is best in its strictly passive role to all other systems, such as the avionics box which deserves its own recognition. This is true also of every other system on board. Each one, from engine starters to cabin entertainment systems to TCAS, will perform more effectively and with less interference using its own ground path.

The value of the "universal" shield is questionable in aircraft with composite-material construction, which leads to other concerns about the effects of HIRF-High Intensity Radiated Fields.

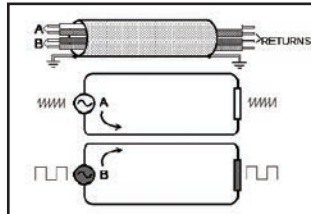

Figure 2. Separate return paths prevent the direct influence of one signal on another. This does not rule out coupling between conductors but eliminates the "free ride" of extraneous signals by way of a ground loop.

Twisted Pairs

Not the name of a rock group.

Shielding is at its best in blocking electrostatic noise fields, and is helpful in shunting some electromagnetic interference, but not near as effective in eliminating EMI as twisting pairs of signal conductors. This has been a popular noise-killer from the early days of telephones.

Every conductor residing in a changing magnetic field acts like the secondary of a transformer – producing some current replicating the waveform of the "primary," or source of the field. (Changes in the field may be due to AC or any varying current in the field source conductor(s) or even physical motion of a DC conductor, such as vibration.) In fact, transformers are designed to take advantage of this fact.

Allowing that every circuit is a circuit (a two-way path for the movement of electrons, or the signal), current will flow in both wires: the pair. External fields happily induce some current in these conductors, caring not at all whether this will pollute the signal in the circuit.

Untwisted pairs invariably position one conductor closer to the field source, and while they may receive nearly the same induction (thus having a "balanced" noise in both), it is never actually quite the same. As a result, there will always be at least some undesirable differential current induced.

By twisting the signal pair, the conductors alternate in nearness to the noise field over each twist cycle, effectively canceling the effect of the polluting field. In effect, while the noise is present in both wires, the twist helps assure it will be equal in each wire, and the result is near-perfect balancing.

The best approach to minimizing unwanted signal "exchanges" is to simply add space between cables – but often this is difficult or impractical. In such cases, triax, twisting, and/or sensible grounding can help a lot.

TECHNICAL ARTICLE #8

Wire Gauge

The common standard for the diameter (gauge) of round drawn wire is the American Wire Gauge (AWG).

As strands of wire are made, they are drawn through progressively smaller dies. This is true of all wire. In fact, the AWG sizing system suggests this drawing procedure. For example, a size 22 AWG wire, smaller than 20 AWG, is drawn, theoretically, through 22 progressively smaller dies. Larger wire is drawn through fewer dies; hence, the lower number "gauge." See Table 1.

Bare Annealed Copper

AWG	Dia (in.)	Circular Mils	Ohms per 1000 ft.	Lbs per 1000 ft.
10	0.1000	10000	1.00	31.43
12	0.0791	6250	1.60	19.77
14	0.0633	4000	2.50	12.43
16	0.0500	2500	4.00	7.818
18	0.0395	1563	6.40	4.917
20	0.0316	1000	10.0	3.092
22	0.0250	625	16.0	1.945
24	0.0200	400	25.0	1.223
26	0.0158	250	40.0	0.769
28	0.0125	156	64.0	0.484
30	0.0100	100	100	0.304
32	0.0079	63	160	0.191
34	0.0063	40	250	0.120
36	0.0050	25	400	0.076
38	0.0040	16	640	0.048
40	0.0032	10	1000	0.030

Table 1. Chart of wire sizes. Circular Mils is the square of the diameter in thousandths, and is useful for comparison of the cross-sectional area of a conductor.

But there's some background to these numbers which may help lend some "rhyme & reason" to how they relate... and in fact will provide a means of relating one gauge to another.

Factor 1 - Every three gauge numbers (#20 to #23, for example) represents a division (or multiplication) of the cross-section and resistance by a factor of 2. Or, referring to the table, which lists only even-numbered gauges, AWG #20 vs #26 would yield a factor of 4. To illustrate, #20 AWG copper wire has a cross section of 1,000 circular mils (CM) and resistance/1000 ft of 10 ohms. #26 AWG, which is smaller, will have a cross section of 250 CM and resistance of 40 ohms. (All values are nominal.)

Factor 2 - Every 10 gauge numbers (#20 to #30 AWG, for example) represents a 10-fold increase or decrease in cross section and resistance. Example: #30 AWG wire is 100 CM (1/10 that of #20 AWG) and 100 ohms per 1,000 feet (10 times that of #20 AWG).

Factor 3 - As a basis for all these numbers, #10 AWG copper is 1 ohm per 1,000 feet.

Having knowledge of these factors can help to simply calculate (or at least estimate) these wire parameters.

Stranded vs. Solid

Well, they are clearly different in appearance, though their purpose is the same. It stands to reason stranded construction would be more flexible. So unless you actually want stiffness—to push a wire through an opening, for example—wouldn't stranded appear to be the better choice?

Then, too, there's strength in numbers: rope, for example, is made of many parallel fibers—individually weak, but together quite strong. If one fiber breaks, there are many left to carry the load.

House wiring is generally solid; wiring for machine tools, automobiles, and aircraft is almost all stranded—for flexibility and redundancy in the face of vibration.

The application dictates the choice of conductor type. At high frequencies—above, say, 1,000 MHz—conductivity relies more on the surface of the conductor than its core. This is the "skin effect," and the reason silver plating becomes important. This also applies in very high current situations—beyond that experienced in the typical aircraft situation, but occurring in major power distribution grids, for example.

TECHNICAL ARTICLE #8

The center conductors of some land-based high-power RF antenna feeds, where size and flexibility are not issues, may actually be a hollow tube—giving further evidence to the relative unimportance of the interior of the wire as a conductor in such applications.

With adequate support by the insulation—as with coaxial cable—a solid conductor will survive the vibration and yet carry an RF signal more efficiently than its stranded counterpart.

This is not meant to imply that all good RF cables should have solid conductors; for the sake of flexibility, some coaxes often have stranded, silver-plated center conductors and work very well.

As always, trade-offs are omnipresent.

Stranding

Conductor ¹	Factors ²	Conductor ¹	Factors ²
1	Prime	427	7
7	Prime	567	2,3,9
10	2	637	7,13
16	2,4,8	665	5,7,19
19	Prime	703	19
37	Prime	836	2,4,11,19
41	Prime	1,045	5,11,19
42	2,3,7	1,050	2,3,5,7
49	7	1,064	2,4,7,8,19
63	3,7,9	1,078	2,7,11
65	5,13	1,323	3,7,9
133	7,19	1,519	7
152	2,4,8,19	1,666	2,7,17
259	7	1,672	2,4,8,11,19
304	2,4,8,19	1,813	7
308	2,4,7,11	1,976	2,4,8,13,19
413	7	2,100	2,3,5,7

¹Conductor: Total number of strands
²Factors: (Mathematical) Not all-inclusive

Table 2. Cable stranding standards

A side issue: Why do you suppose that the number of strands is almost always an odd — usually prime — number? The answer is below...

Table 2 is a chart of some stranding configurations, and some of their factors. This is hardly all-inclusive, but illustrates the idea.

The construction of stranded wires almost always involves a prime number of strands. [A prime number is defined as one which is divisible only by itself and by 1.] Among larger numbers of strands (more than, say, 250), this may stray from "primeness," but remains an odd number. And in wires having a very great number of strands, (above maybe 1000), there are instances of even-numbered strand counts. These departures from the norm, however, are few: the norm is truly a prime number.

Why?

A solid (1-strand) conductor is the heart of a wire. Stranded wires, then, are surrounded by additional strands, and if all the strands are of the same gauge, six of them fit, ideally, around the center strand. Total: 7. Add another layer (12 will lay best, in minimum space) around those, and it becomes 19.

And so on...

Stranding in larger numbers often entails using bundles ("odd-ly", or "prime-ly" stranded) as if they were individual wires—so that a given high-number stranded construction may become a prime number of prime-numbered "mini" bundles. Confusing? Why not? It's the legacy of a very old business — rope-making.

TECHNICAL ARTICLE #9

Shield Types

Served shields are spiral-wound groups of small-gauge wire strands surrounding the insulation of the conductor(s). They are easy to unwind and terminate, but are prone to be relatively inductive because they are coiled around the cable. They are the most flexible of shielded cables, and are often used in audio applications. Served shields are usually soldered, or crimped to a lug or termination post.

Braided shields are woven over and under one another to form a tight but flexible cylinder of wires. This may result in the need to unbraided or loosen the weave in order to terminate it, though it lends itself to easy coaxial connector termination, and preserves the shield all the way to the connector body. 95% coverage is not unusual on high quality cables.

Most commonly, braids are formed of groups of small-gauge wires known as "carriers." These are laid side-by-side, a ribbonlike multi-path conductor. Braids can also be a "strip braid," using solid ribbons of conducting material, providing a more uniform inner surface to a coaxial conductor. This is an advantage at very high frequencies, and if it is combined with other shield designs, forms a very effective EMI barrier.

Braided coax shields are usually terminated in the field by crimping or clamping, and are occasionally soldered, or are terminated with a heat-shrink shield pigtail. This latter approach is common in aircraft wiring harnesses. Braided non-coax shields can be soldered if the conductors within are dressed to exit the shield through an opened space in the braid, or can be terminated with a heat-shrink shield pigtail.

Foil shields consist of a metallized flexible plastic (Mylar, polyimide, etc.) wrapper, spiraled around the conductor(s). The metallized layer is very thin — on the order of .0003 inch. Foil coverage can be effectively 100%, although its resistance is far greater than the other shield described here, and thus its ability to shunt noise is limited. For this reason, EMI protection is best if foil shields are used in combination with braided (better conductors) shields.

Foil shields, since they are usually aluminum, are necessarily crimped, though some are combined with a "drain wire", which makes contact with the foil and may be soldered.

Solid shielding comprises a metal tube, rigid or semi-rigid — usually copper or aluminum — surrounding the dielectric and center conductor. Semi-rigid coaxial cables of this design can be formed by hand, though tube bending tools are recommended, especially for smooth tubing. (Larger cables may incorporate a corrugated-like tubing.) Coverage is 100% and resistance is low. There is no better shield.

Common applications of solid-shielded types include short, fixed coax jumpers inside an instrument, or ground based antenna feeds.

Solid shields are usually soldered or clamped. Soldering aluminum solid shields is impractical.

Shield Coverage depends upon design and level of quality—and ranks from poor to perfect. Not every application justifies the costly pursuit of perfection. The degree of need depends on the frequencies of concern and the noise susceptibility (or signal strength, for shield containment roles) of the circuit.

Shield Termination should not be taken lightly, since more problems crop up at connectors than any other part of a cable.

In all cases, shield integrity is best if the shield is intact (no broken strands or flaking foil) and prepared for maximum contact with the connector. This includes cleanliness. The connector manufacturer's instructions deserve serious attention.

Shield Effectiveness

Regardless of its construction, a shield will be only as immune to induced noise as its effectiveness provides. This means that the shield will "intercept" and/or deflect magnetic or electrical fields which interfere with the signal needed. Frequency, amplitude and physical spacing are factors. Management of the problems of noise — induced, or as a source — includes shielding.

Shielding effectiveness is the ratio of incident wave (source) field strength to the allowable field strength. It is customarily expressed in dB.

TECHNICAL ARTICLE #9

Shields can function as reflectors or absorbers (shunting to ground) of radiated electrical or magnetic fields. Since in avionic systems we commonly concern ourselves with rampant RF, we'll focus on properties of shields which are most effective at high frequencies.

Reflection of unwanted signals can be likened to a mirror. The surface of the shield is the operative element, and in truth, it is the conductivity of this surface — the skin — which plays the most important role in high frequency applications. This is one excellent reason for the silver plating on the shielding wires used in high performance cables.

Beneath the reflective surface, the conductivity of copper lends itself well to absorption, draining the interfering signal to ground. While copper is not as effective as steel in absorption of frequencies below 1GHz, it is a more effective shield, overall, if both absorption and reflection are taken into account.

As the shield is designed, it is not necessarily true that layer upon layer of shields are any more appropriate than simple well-made shields may be. Sometimes, however, layering can block openings (interstices — the intersections of braid elements), important because even a pinhole is a window to noise at high frequencies.

Shields are beneficial in containing interference as well as protecting from it, serving to reduce the effects of noise which might be induced in neighboring cables, or bundles of wires.

Testing for leakage in coaxial cable shields tells the story of how to cope with the RF "traffic jam" that is now more invasive than ever anticipated.

It is a given that 100% shielding, such as provided by rigid or semi-rigid cables, is an ideal. What is less evident is that MIL-C-17 coaxial cables are far off the ideal. Perhaps this is why PIC's multi-layer low-loss cables are increasingly accepted — for perhaps other reasons, too, such as loss or weight — but bring the substantially improved leakage factors along as well.

Network analyzer testing of PIC coax designs—incorporating the silver-coated inner strip braid, the metallized polyimide 100% wrap, and the tight wire outer braid—show performance that approaches that of semi-rigid cables. Comparison testing shows leakage on the order of 55-75dB for RG142, and 85-90dB for PIC S44193. Semi-rigid RG402 is 110dB. (These are all cables whose other characteristics are roughly comparable.)

To summarize, shielding usually just works. But if EMI problems crop up—and they will when you least expect them—it is always important to consider the quality of the cable as a first line of defense.

What's the importance of all this? In the complex RF environment of an ever-growing rat's nest of signals, often bundled together and "sharing" noise, better shielding improves signal integrity and system reliability.

AVIONICS SYSTEMS TEMPLATES

AVIONICS SYSTEMS TEMPLATES AVAILABLE FOR DOWNLOAD FROM OUR WEBSITE

www.PICWire.com/assemblies/assembly-worksheets

- AERO-HSD+ W_AMT-50
- AERO-HSD+ W_HGA-7000
- AERO-SB+ W_HGA-7000
- AirCell Axxess II
- AIS-1000
- AIS-2000
- AST-3500
- CAS 66/67 Omni
- CAS 66/67 Dual
- CAS 81 Dual
- GTX-330D
- HSD-128_400_440 W_AMT-3800
- HSD-128_400_440 W_AMT-50
- KMH 880_KTA 870 TAS W_Omni
- KMH 880_KTA 870 TAS
- MST-67A
- RCZ-852 MODE-S
- SAT-2000
- SkyWatch 497/889
- ST-3100
- ST-3120
- T2 CAS Dual
- TAILWIND 100
- TAILWIND 500
- TAILWIND 550
- TAILWIND 560
- TAS 600 Series - Ryan 9900BX
- TCAS 2000 Dual
- TCAS 3000 Dual
- TCAS 4000 Dual
- TCAS 791
- TCAS 94 Dual
- TDR-94D Mode - S
- TRA-67A Mode - S
- TT-3000 Aero-M
- TT-3024 Aero-C
- TT-5000 Aero-I
- XS-950 Mode-S