

16 Series Thermal Circuit Breaker

Hi Amp ; Single Pole

• Technical data

Rating: 30-250A, 48VDC.

Interrupt Rating:

2,000A / 32VDC. Type I

2,000A / 14VDC. Type III

1,500A / 48VDC. Type III

Operating Temperature Rating: -30°C to 80°C

Storage Temperature Rating: -30°C to 140°C

Materials: UL-Rated 94V-0 Thermosetting plastics body.
Nickel-plated copper alloy stud.

Insulation Resistance: 100M, 500VDC

Dielectric Strength: 1800V 1 minute

Meet SAE J1625; J1171; UL1500

Torque rating : 10 N.m (Max)

Stud size: 1/4"-28t

• Trip Time

100% of rated current: Hold, no trip within 30 minutes.

135% of rated current: Trip within 30 minutes.

200% of rated current: Trip in 12-45 seconds.

300% of rated current: Trip in 3.5-12 seconds.

• Trip Time Curves

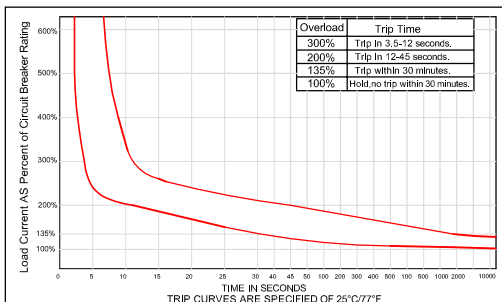

• Temperature Derating Curves

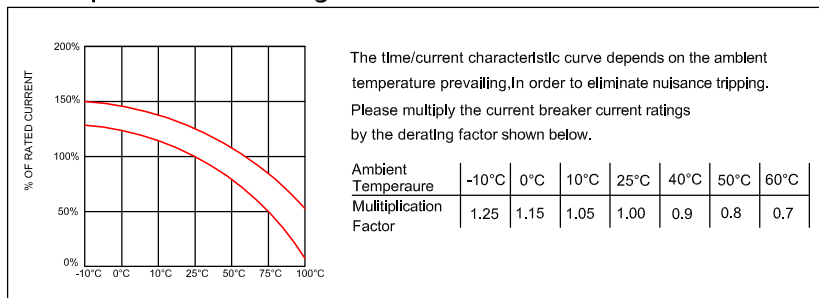

Surface Mount

Large size (150A-250A)

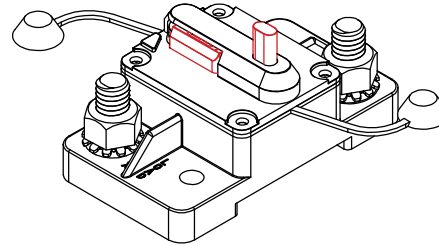

16-8F=Type III+Switch
(Switchable/Manual)

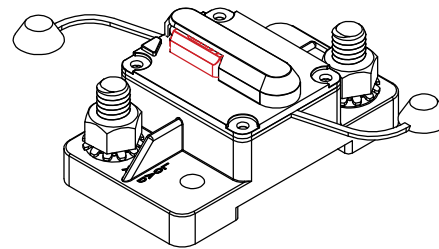

16-3F=Type III
(Manual Reset)

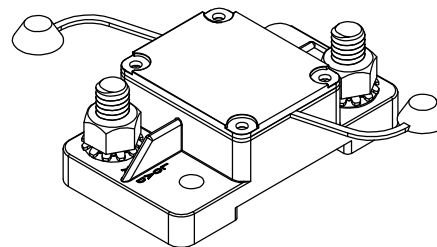

16-1F=Type I
(Auto Reset)

Panel Mount

Small size (30-150A)

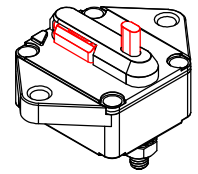

16-8P=Type III+Switch
(Switchable/Manual)

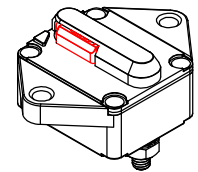

16-3P=Type III
(Manual Reset)

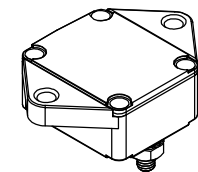

16-1P=Type I
(Auto Reset)

16-XX-XXX-XXX

Customer code

Button (8F/8P/3F/3P)

R= RED
Y= Yellow

Size

S= Small size (30A-150A)
L= Large size (150A-250A)
P= Panel Mount (30A-150A)

Amp Rating

Q30= 30A 110=110A
Q40= 40A 120=120A
Q50= 50A 130=130A
Q60= 60A 140=140A
Q70= 70A 150=150A
Q80= 80A 160=160A
Q90= 90A 180=180A
100=100A 200=200A
250=250A

Fixed mode

F=Surface Mount
P=Panel Mount



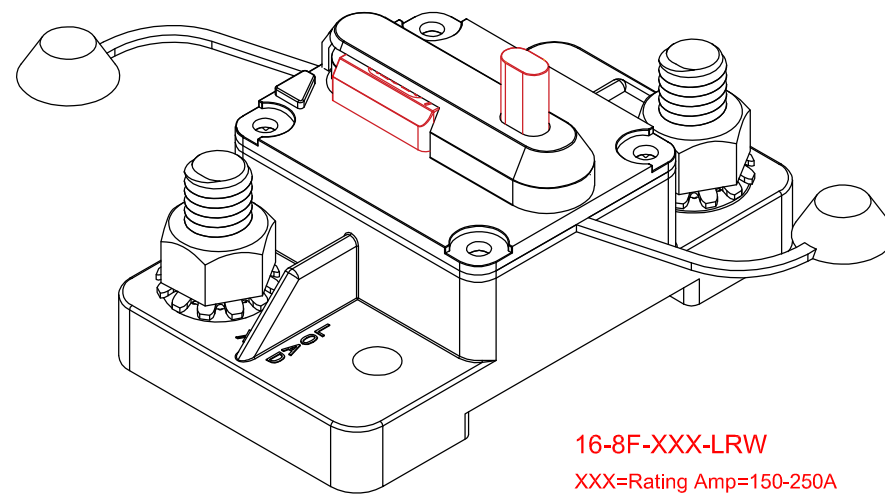
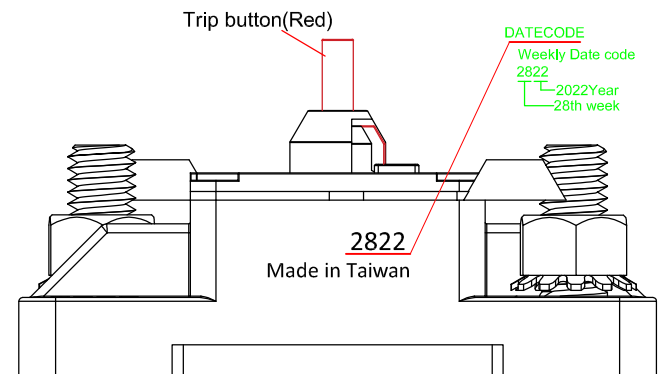
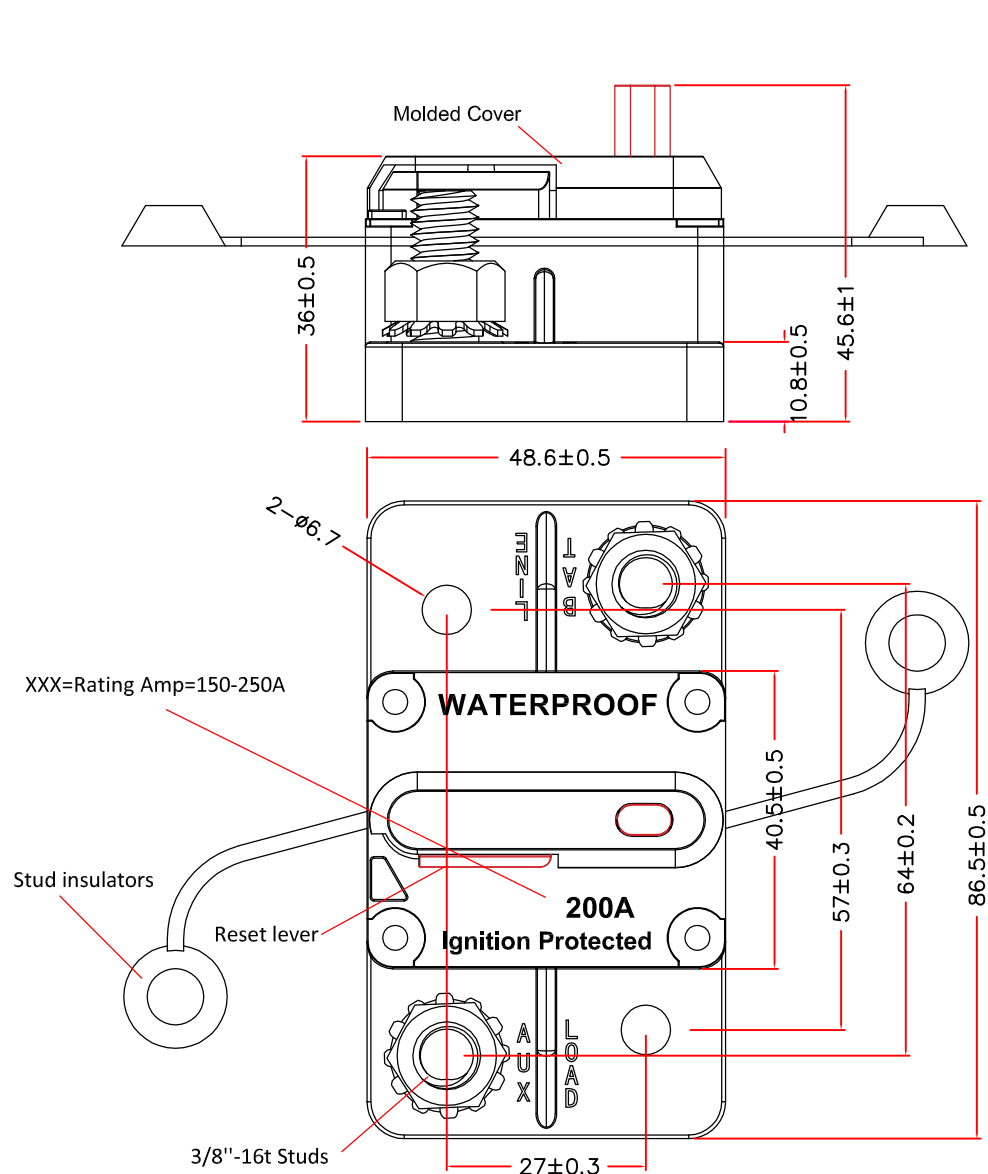

Actuation mode

1=Type I (Auto Reset)
3=Type III (Manual Reset)
8=Type III+Switch (switchable/Manual)

KUOYUH® 16 Series Thermal Circuit Breaker

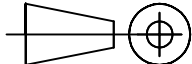

P/N:16-8F-XXX-LRW

NO	DESCRIPTION	APPROVED	DATE	TOLERANCE		APPROVED	DESING	DRAWER	Unit(單位)	mm	
				DIMENSION	TOLERANCE				Scale(比例)		
5				XX.XX	±0.05				Scale(比例)		
4			XX.X	±0.1	Rev(版本)				A/2		
3			XX	±0.15	Material(材質)						
2				ANGLE	TOLERANCE	國郁企業股份有限公司			Title(品名)	16-8F Hi-amp CB	
1				X	±1°				KUOYUH W.L. Enterprise Co.,Ltd.		
				X.X	±0.5°						